

Performance Evaluation of Bluetooth Links in the Presence of Specific Types of Interference

Radosveta Sokullu and Engin Karatepe

Abstract— In the last couple of years Bluetooth has gained a large share in the market of home and personal appliances. It is now a well established technology a short range supplement to the wireless world of 802.11. The two main trends of research that have sprung from these developments are directed towards the coexistence and performance issues of Bluetooth and 802.11 as well as the co-existence in the very short range of multiple Bluetooth devices. Our work aims at thoroughly investigating different aspects of co-channel interference and effects of transmission power, distance and 802.11 interference on Bluetooth connections.

Keywords—Bluetooth, co-channel interference, 802.11, performance analysis

I. INTRODUCTION

ONE of the dominant technologies in the current short range wireless world is undoubtedly Bluetooth. Over 900 million Bluetooth-enabled devices are expected to be in existence 5 years from now. This poses the case of studying possible interference issues as a major one. Users of Bluetooth can experience interference from different source using the same ISM band – mainly Wireless LAN, home appliances and other Bluetooth devices in the vicinity. Channel interference greatly reduces the so precious bandwidth and adversely affects the achievable BER. Performance analysis is based simulation tools like the Network Simulator ver.2 (NS-2) and its Bluehoc and Blueware extensions[8, 9, 11]. However these studies focus mainly on the scatternet formation and less on the mutual independent existence of separate piconets in very close vicinity. There are very few analytical and simulation results concentrating on the co-channel interference, observed between independent neighboring piconets hopping on the same frequency.

Users of Bluetooth enabled communication devices can experience interference from two major groups of devices – on the one hand we have devices that work in the same ISM band but use different transmission technique like for example microwave ovens, baby monitors, cordless phones etc. The effects of these are to a great extent reduced by the FHSS used in the Bluetooth transmission. Another big interferer is the wireless LAN and transmissions following the 802.11 standard. As they use a very wide band of 22 MHz (compared to the 1Mhz band used in Bluetooth FHSS), it is expected that they should show quite a negative effect on the performance

of the Bluetooth devices. Another very important but so far little investigated is the so-called co-channel interference which arises when two independent piconets hop on the same frequency of the desired signal. This results in an adverse effect on the achievable BER and consequently the data rate for each user. Because of the specifics of the software used in most research so far this subject has been neglected to a certain extent while more stress has been put on creating and organizing transmissions among connected piconets forming the so called scatternets. Obviously the situation is different in a scatternet when there is synchronization between the participating piconets. Actually in near future with the exploding increase in the number of Bluetooth enabled devices the interference, experienced in independent adjacent piconets, might easily turn into a serious problem. There are very few studies in this respect known to the authors [2,4,5]. In the analytical model presented in [5] the distribution of the devices is taken as uniform, without a possibility of directly observing the effects of the distance between pairs of devices and the strength of the transmitted signals. The included simulation based on NS-2 provides insight based on the topology for the success rate in the case of data packets but does not cover the subject of SCO links. In [8, 9] a comparison is presented based on NS-2 simulation model between the performance of Bluetooth and WaveLAN. A valuable work that gives more inside on how Matlab tools can be incorporated in physical modeling of Bluetooth radio links is presented in [10].

Our study concentrates on the co-channel interference analysis on the physical layer in the presence of more than one adjacent Bluetooth piconets. We examine several metrics as the BER and the E_s/N_0 in the presence of a noisy channel, a IEEE 802.11 interfering transmission, taking into consideration the different packet types as specified for the SCO links in the standard.

From here on the paper is organized as follows: in the second part we review the main specifics of the Bluetooth physical layer; in the third we explain the simulation environment we are using and describe the models that we have studied. In the last part we give the results and some concluding remarks.

II. THE BLUETOOTH TECHNOLOGY

A. The Bluetooth Protocol Architecture

The Bluetooth standard [1] gives details on the architecture of the communication protocols. It specifies voice and data transfer over a radio channel with a maximum capacity of up to 1 Mbps. According to the standard Bluetooth works in two modes of short range – the low power (1mW) 10m and the higher power (10mW) for up to 100 m distance. It was aimed at replacing cable connections between devices which in most cases form a personal area network (PAN) like mobile phones and earphones, laptops and PDAs. Nowadays though, due to its flexibility and very little power consumption, Bluetooth enabled devices find applications in different control systems in Home Networking as well as in small mobile ad-hoc sensor networks used in medical and industrial settings. Such type of integrated Bluetooth applications are envisaged as the greater share of the future Bluetooth market. [6]

Bluetooth provides a point-to-point (only two Bluetooth devices sharing a channel) or point-to-multipoint connections where more than two devices share the channel. It uses a master-slave communication model with frequency hopping spread spectrum (FHSS) transmission technique in the ISM band. The bandwidth of 81 MHz is allocated from 2.402GHz to 2.483 GHz (in USA and most European countries) and is divided into 79 radio frequency channels of 1-MHz each, providing a raw data rate of 1 Mbps. The modulation scheme is Gaussian Frequency Shift Keying (GFSK). In a piconet the transmissions of separate devices (in a point-to-point connection) or receiving by separate devices (in a point-to-multipoint connection) do not collide because the hopping frequency is governed by the master. The channel is represented by a pseudo-random hopping sequence hopping through the 79 channels. The hopping sequence is unique for the piconet and is determined by the Bluetooth device address of the master; the phase in the hopping sequence is determined by the Bluetooth clock of the master device. The nominal hop rate is 1600 hops/s. Transmission is organized in a time division duplex (TDD) manner where in a slot of 625 μ s a master polls a device and the device has to answer in the next following slot.

B. Specifics of the Physical Link

The Bluetooth standard defines two types of links for the support of voice and data transmissions. The synchronous connection-oriented (SCO) link is devised to meet the special requirements of time bounded transmissions with higher error tolerance than data transmissions. The SCO link is a symmetric, point-to-point link between the master and a specific device from the piconet. It reserves slots and can be considered as a circuit switched connection between the master and the slave. Due to the time constrain the SCO link does not allow retransmission. A master can support up to three simultaneous SCO links.

The asynchronous connectionless (ACL) link is devised for data transmissions. The master exchanges packets with a slave on a per-slot basis. The ACL link provides a packet-switched connection between the master and all the slaves in the

piconet. Only one ACL link is allowed between a master and a slave. To assure data integrity and lower bit error rate (BER) packet retransmission is applied. A slave has to answer the master in the next following slot but only if it has been addressed by the master in the previous master-to-slave slot.

C. Definition of the Packet Formats in the Baseband Specification

The packet types used on the piconet are related to the physical link they are used in. Altogether there are 12 packet types defined, 5 of which are common for both the SCO and ACL link – the ID, the NULL, the POLL and the FHS packet which serve mostly OAM functions and the DM1 packet type which can carry both control information and data.

The SCO packets used mainly for 64 kb/s voice do not include a CRC and are never retransmitted. There are three pure types of SCO packets – HV1, HV2 and HV3 (Fig.1). The HV1 carries 10 bytes of information, protected by 1/3 FEC (Forward Error Correction) thus the payload length is fixed at 240 bits. An HV1 packet carries 1,25 ms of speech at 64 kb/s rate, which means that an HV1 packet occupies one slot and has to be sent every two time slots. A new hop frequency is used at every new slot for the voice transmission. The HV2 has the same fixed payload length of 240 bits, but it is protected by 2/3 FEC and thus can carry 20 bytes of information. An HV2 reserves two tie slots in each direction and has to be sent every 4 time slots, providing 2.5ms of speech at 64 kb/s rate. The HV3 carries 30 bytes of information with no FEC or CRC present, resulting in an equivalent 240 bits payload length. It can carry 3.75 ms of voice, one HV3 packet being sent every 6 slots. Another type of packet specified for the SCO links is the hybrid DV packet which carries both voice and data in respectively 80 and 150 bits fields. The voice and data field are treated completely separately and the voice part is never retransmitted. (each new DV packet contains a new voice field). The voice field is not protected by FEC, but the data field contains a 16-bit CRC and is additionally encoded with a 2/3 rate FEC.

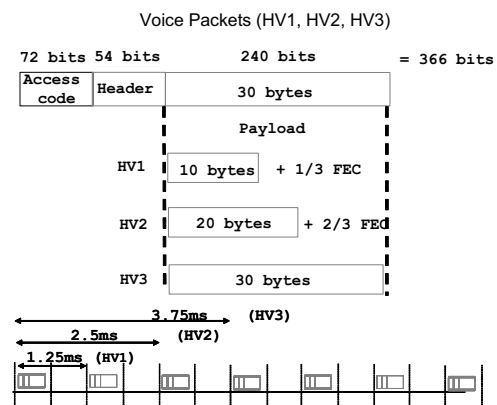

Fig. 1 Structure of the voice packets

The ACL packets on the other hand require heavy retransmission, FEC and CRC protection (Fig.2). There are 6 pure ACL packets defined. The DM1 (data medium rate) carries up to 18 bytes of information plus CRC encoded with 2/3 FEC. It occupies a single slot. There is also a DH1 (Data High Rate) packet specified for one slot transmission, where the information is not protected by FEC but includes only 16 bit CRC thus providing a possibility of carrying up to 28 bytes of information. The DM3 packet is a DM1 packet with an extended payload, carrying up to 123 bytes of information. It covers three slots and the hopping frequency is kept the same for transmission of whole packet. The corresponding DH3 is similar to the DM3 packet except that it does not have FEC. The DM5 is a DM1 packet with an extended payload, up to 226 bytes, that spans 5 slots. The hopping frequency remains the same as in the first slot where the access code is transmitted. The highest possible asymmetrical transmission rate is achieved by the use of a DH5 packet. It is similar to the DM5 packet but does not include FEC and can carry up to 341 bits of information plus the 16 bit CRC code. In an asymmetric ACL link it can provide throughput up to 721.0 kbps in one direction and 57.6 in the other direction.

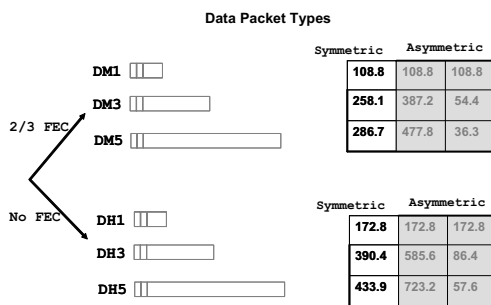

Fig.2 Structure of the Data Packets

III. THE MATLAB SIMULATION ENVIRONMENT

Even though there has been quite a few successful attempts to model and simulate the Bluetooth operation most of them utilize the NS-2 and its extensions for specific Linux environments (Blueware and Bluehoc) [5,7,8,9]. All these tools provide very high level description possibilities and do not allow detailed capture of the physical specifics of the Bluetooth Baseband transmission. Recently the authors have found a nice example [10] of utilizing the possibilities of the very powerful Matlab Simulink environment. In our work we have concentrated on testing the possibilities of a Matlab model and compare the performance results for different cases of co-channel interference. The communication system described in part II, including the details of the packet types and their specific transmission characteristics can be very precisely constructed using blocks in the Simulink like the DSP Blockset and the Communications Blockset libraries. The communication link between the master transmitter and the slave receiver for voice transmissions is composed of speech processing, framing, coding, modulation, frequency hopping, radio interference and a radio channel model. These

can be implemented one by one according to Bluetooth specification [1] and then can be put together in the Simulink tool. In our simulations, Bluetooth Simulink block libraries are used [10] and three separate Matlab/Simulink programs are constructed for performing the BER tests.

IV. THE SIMULATION MODEL

In our studies the simulation model comprises a master transmitter and a slave receiver, a radio channel, 802.11b interfering module, another Bluetooth pair operating in a separate piconet thus causing interference for our set, error meters and instrumentation. The model allows us to control and record precisely all the physical parameters and changes that affect the Bluetooth transmission thus influencing the performance that we are trying to evaluate.

In the Matlab environment the noisy channel is simulated by an AWGN channel whose SNR can be controlled. The 802.11 is generated by a separate independent block which allows us to control precisely the rate of 802.11 transmission. In the first set of simulations we have studied the combined influence of the noisy environment worsened by a neighboring 802.11 transmitting wireless device. We have also made a point to examine if there is any difference in the performance and the way the BER is affected in different types of packets. The simulation parameters for these cases are summarized in Table 1 and Table 2.

Opposing to other known studies and analytical models mentioned before our simulation model allows us to carry a set of experiments directly investigating the effects of the distance between the transmitting devices on the BER. The simulation parameters for the different packet types are presented in Table 3.

V. DISCUSSION OF SIMULATION RESULTS

In order to study the behavior of a Bluetooth connection we have devised the following simulation cases.

CASE 1: Examine the BER versus hop frequency. In this case we have included the situation when in the close vicinity of the Bluetooth devices we have a noisy channel as well as 802.11 interference. The effect is cumulative but definitely the 802.11 has a decisive part. Our simulation shows that despite the fact that different types of voice packets (HV1, HV2 and HV3) have different FEC schemes the longer presence of 802.11 interference leads to substantial, unacceptable levels of BER. It is also interesting to notice that the HV2 are most sensitive to this type of interference. The results are presented in Table 1. and Figs. 3-5.

Table 1. BER versus hop frequency for HV1, HV2 and HV3 packets

AWG N	802.11 Rate	Simulation Time [μ s]	M/S Path Loss	802.11 Path Loss
Es/No	999	200/1600	-40 dB	-40 dB

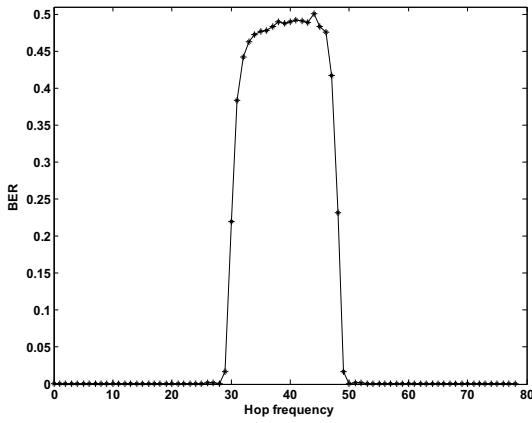

Fig. 3 Performance of HV1 packets

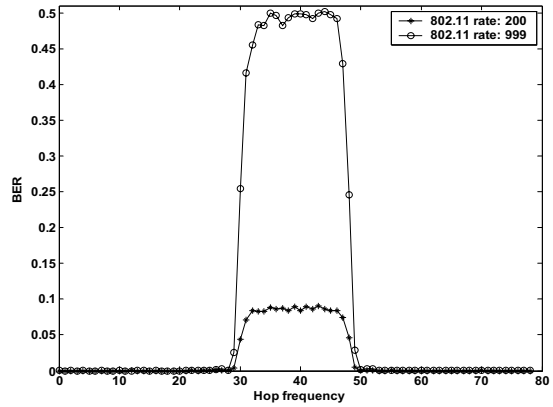

Fig. 6 Comparison of BER for light and heavy 802.11 interference for HV3 packets

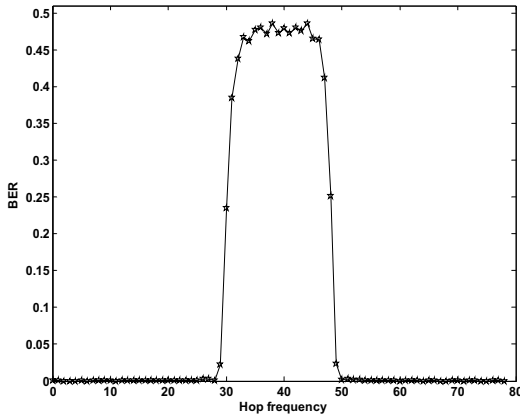

Fig.4 Performance of HV2 packets

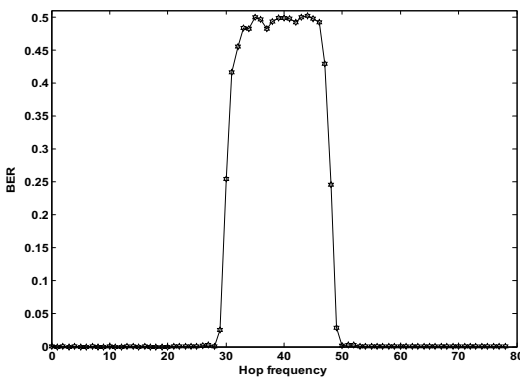

Fig. 5 Performance of HV3 packets

The decisive effect of the 802.11 interference and its strength is clearly noticeable from the comparison presented in Fig.6. We have observed a nearly 10 fold increase between the min IEEE 802.11 packet rate of 200 and the max of 999.

CASE 2: Another interesting case is how the performance of Bluetooth connections is influenced by the distance between the master and the slave. According to the Bluetooth standards the effective range of 0.001 W devices is up to 10 meters. But in the presence of a noisy channel and a 802.11 interfering transmission this distance is much reduced. The behavior as can be seen from Fig. 7 is non-linear. There is a very short optimal range up to 4 meters. It is also possible to study the different behavior of HV1, HV2 and HV3 packets. At 2m the HV2 packets experience a 0.005 BER compared to 0.025 for the HV1 type and 0.04 for the HV3 type. HV2 type does not only show better performance but it is also least sensitive to the increase in the distance. It is interesting to note that similar results have been reported by the analytical and simulation findings in [5] for specific ACL packets.

Table 2. BER versus distance for HV1, HV2 and HV3 packets

AWG N	802.11 Rate	Simulation Time[μ s]	M/S Path Loss	802.11 Path Loss
Es/No	200	200/1600	up to 20m	-40 dB

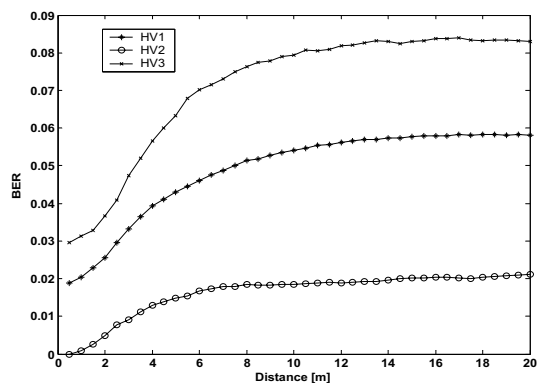

Fig. 5. BER versus distance between the master and the slave

CASE 3: As we have observed out of all types of interference the strongest is the interference experienced by neighboring independent piconets hopping simultaneously (Table 3. and Fig.6). To study their performance we have devised a simulation that examines the BER for a master-slave piconet pair and introduced the active transmission of another master slave pair in the vicinity. In this case the 802.11 interference is turned off. The simulations have been repeated for the different types of packets. The Es/No is varied in the range of -10 to 10 dB. The 3D results presentation allows us to determine a transmission effective zone depending on the Es/No ratio.

Table 3. BER versus distance and Es/No for HV3

AWGN Es/No	802.11 Rate	Simulation Time [μ s]	M/S Path Loss	802.11 Path Loss
-10-10dB	200	200/1600	-40 dB	up to 10m

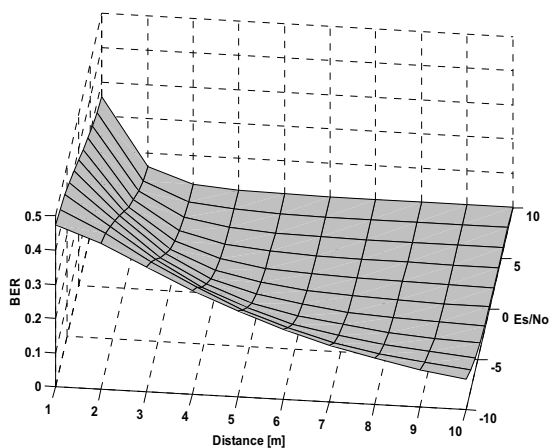

Fig.6 3D mesh of simultaneously transmitting Bluetooth pairs

VI. CONCLUSION AND FUTURE WORK

In this paper we have presented some initial results on using the powerful Matlab tool for simulating and investigating the performance of Bluetooth connections. We have shown that for the physical layer simulation Matlab Simulink allows us to keep close to the details of the Bluetooth communication link and examine in detail the influence of separate parameters. We have done this for the SCO links so far but we intend to extend the model to cover the ACL links as well. The result will be a powerful alternative simulation environment for studying the details Bluetooth devices and Bluetooth enabled devices in different configurations.

References

- [1] Bluetooth Specification SIG, [Online], Available: <http://www.bluetooth.com>
- [2] N. Abramson, *The throughput of packet broadcasting channels*, IEEE Trans. Comm., vol. COM-25, pp.117-128, Jan.1997
- [3] J. Haarsten, *Bluetooth – the universal radio interface for ad hoc, wireless connectivity*, Ericsson Review, no.3, pp.110-117, 1998.
- [4] S.Zurbes, *Considerations on Link and System Throughput of Bluetooth Networks*, PIMRC 2000, pp.1315-1319
- [5] C.M.Cordeiro, D.P.Agrawal, D.H.Sadok, *Interference Modelling and Performance of Bluetooth MAC protocol*, IEEE Trans. Comm. Vol 2, No.6, Nov. 2003. pp.1240-1246
- [6] J.P.Lynch, *Co-channel Interference in Bluetooth Piconets*, Virginia Polytechnic Institute, Master of Science Thesis, Ch.3, 2002
- [7] C.Hsu, Y.J.Joung, *An NS Based Bluetooth Topology Construction Simulation Environment*, Proceedings of the 36th annual Simulation Symposium, ANSS 2003
- [8] G.Tan, *Blueware: Bluetooth Simulator for NS-2*, [Online], Available from: godfreyt@lcs.mit.edu
- [9] Bluetooth Extension for NS, [Online], Available: <http://oss.software.ibm.com/d/developmentworks/opensource/bluehoc/>
- [10] *Matlab Simulink*, [Online], Available: http://www.mathworks.com/matlabcentral/bluetooth_file
- [11] *Network Simulator (NS-2)*, [Online], Available: <http://www.mash.cs.berkeley.edu/ns>

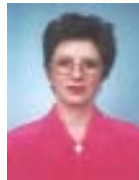

Radosveta Sokullu received an M.Sc. degree in 1985 and a PhD in 1991 from the Sofia Technical University, Sofia, Bulgaria. She specialized in Advanced mathematics and programming as a postgraduate student at the Center of Applied Mathematics.

In 2000 she became an Assistant Professor at the Department of Electrical and Electronics Engineering at Ege University, Izmir, Turkey and in 2002 she was appointed Chair of the Telecommunications Branch.

Her research interests are in the field of teletraffic modeling and simulation and more recently mobile and wireless systems especially ad-hoc networks.



Engin Karatepe received the B.Sc. degree from Gaziantep University, Gaziantep, Turkey, in 1995, the M.Sc. degree from Ege University, Izmir, Turkey, in 2000. He is presently working towards the Ph.D. degree in energy technologies at the Ege University.

Since 1996, he has been with the Department of Electrical and Electronics Engineering, Faculty of Engineering, Ege University, where he is currently a Research Assistant. His research interests are in measurement and control of photovoltaic systems, renewable energy system modeling, fuzzy logic control, neural network, and Bluetooth networks modeling.