

Sensorless Sliding Power Control of Doubly Fed Induction Wind Generator Based on MRAS Observer

Hicham Serhoud, Djilani Benattous

Abstract—In this paper present a sensorless maximum wind power extraction for variable speed constant frequency (VSCF) wind power generation systems with a doubly-fed induction generators (DFIG), to ensure stability and to impose the ideal feedback control solution despite of model uncertainties, using the principles of an active and reactive power controller (DPC) a robust sliding mode power control has been proposed to guarantees fast response times and precise control actions for control the active and reactive power independently.

The simulation results in MATLAB/Simulink platform confirmed the good dynamic performance of power control approach for DFIG-based variable speed wind turbines.

Keywords—Doubly fed induction generator, sliding mode control, maximal wind energy capture, MRAS estimator

I. INTRODUCTION

WIND energy conversion systems are becoming increasingly popular because of the demand on renewable energy resources, as a consequence wind power generation technique is being developed rapidly. The wind energy systems using a doubly-fed induction generator (DFIG) have some advantages due to variable speed operation and four quadrant active and reactive power capabilities compared with fixed speed induction generators, variable speed constant frequency doubly fed wind power generator presents noticeable advantages such as, it can keep the optimum tip-speed ratio to get maximum wind-power during a low wind speed and improve the flexibility of the drive system by releasing or saving some energy during high wind speed.

In the first method, the stator active and reactive powers are regulated by controlling the rotor current vector using either stator voltage or field oriented control, based on rotational transformations and linear controllers (proportional– integral controller), has so far proved to be the most popular control technique, although it is clear that its drawbacks are its linear nature and lack of robustness when faced with changes in operational conditions. The problem in the use of PI controller is the tuning of the gains and the cross-coupling on DFIG

terms in the whole operation range, sensitive characteristics to the parameter variation and interference.

DPC control strategy for a DFIG-based wind energy generation system was proposed in [5] [17]. The control method is based on the, the converter switching states were selected from an optimal switching table based on the instantaneous errors between the reference and estimated values of active and reactive power, DPC is robust with respect to the change of machine parameters and to perturbations. However, it has some drawbacks: it exhibits high active and reactive power ripples, and current ripple [4].

In order to achieve the maximum power point tracking (MPPT) the control strategies for DFIG mainly include the cutting-in control, the maximal power point tracking with it the knowledge needed speed of the machine.

A MRAS observer for standalone DFIG operation was presented by the authors in [1] [2] [3] [4], based is a well known method for the sensorless control of cage induction machines.

Compared with these sensor-less methods, this paper proposes the method realize MPPT with/without wind speed measurements it is usually rotor speed observation, therefore it can improve the control system reliability and energy conversion efficiency and The due to both the nonlinear nature and parameters variations of DFIG, This paper presents a very robust approach control of doubly fed induction generators. The control method is based on the variable structure control associated to the flux oriented control technique, the extensive simulation study in the beginning validated all the control algorithms.

II. MATHEMATICAL MODEL OF DFIG

The equivalent two-phase model of the symmetrical DFIG, represented in an arbitrary rotating (d-q) reference frame is: [3,6,14,15].

$$\begin{cases} V_{ds} = R_s i_{ds} + \frac{d\psi_{ds}}{dt} - \omega_s \psi_{qs} \\ V_{qs} = R_s i_{qs} + \frac{d\psi_{qs}}{dt} + \omega_s \psi_{ds} \\ V_{dr} = R_r i_{dr} + \frac{d\psi_{dr}}{dt} - (\omega_r - \omega_s) \psi_{qr} \\ V_{qr} = R_r i_{qr} + \frac{d\psi_{qr}}{dt} + (\omega_r - \omega_s) \psi_{dr} \end{cases} \quad (1)$$

Hicham Serhoud is with Institute of Science Technology, Department of Electrotechnics University Center of EL-Oued, Algeria. e-mail: hichamser_39@yahoo.fr

Djilani Benattous is with Institute of Science Technology, Department of Electrotechnics University Center of EL-Oued, Algeria. e-mail: dbenattous@yahoo.com

The Stator and rotor fluxes are given as:

$$\begin{cases} \psi_{ds} = L_s i_{ds} + M i_{dr} \\ \psi_{qs} = L_s i_{qs} + M i_{qr} \\ \psi_{dr} = L_r i_{dr} + M i_{ds} \\ \psi_{qr} = L_r i_{qr} + M i_{qs} \end{cases} \quad (2)$$

The electromagnetic torque is expressed as :

$$T_e = \frac{3}{2} p \frac{M}{L_s} (\psi_{ds} i_{qr} - \psi_{qs} i_{dr}) \quad (3)$$

The active and reactive powers at the stator side are defined as:

$$\begin{cases} P_s = \frac{3}{2} (V_{ds} i_{ds} + V_{qs} i_{qs}) \\ Q_s = \frac{3}{2} (V_{qs} i_{ds} - V_{ds} i_{qs}) \end{cases} \quad (4)$$

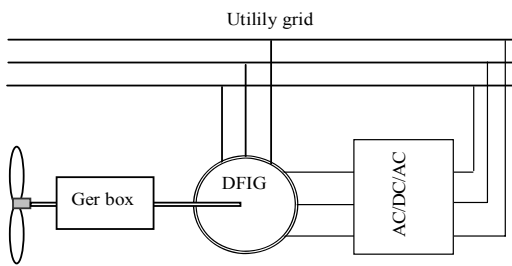

Fig.1 Doubly Fed Induction Wind Generator

III. CONTROL MECHANISM OF THE MAXIMAL WIND ENERGY CAPTURING

Wind energy is captured by the blades of the wind turbine and is turned into mechanical torque on the hub. from Betz theory, the capture power got from wind energy by wind Turbine can be expressed as:

$$P = \frac{\pi}{2} C_p S \rho v^3 \quad (5)$$

Where ρ is the air density, R is the turbine radius and v the wind velocity. Further the power coefficient C_p is a function of the tip speed ratio ($\lambda = \omega_t R / v$) as well as the blade pitch angle β , ω_t is the angular speed of the wind turbine.

$$C_p(\lambda, \beta) = 0.5176 \left(\frac{116}{\lambda_i} - 0.4\beta - 5 \right) e^{-\frac{21}{\lambda_i}} + 0.0068\lambda \quad (6)$$

$$\text{Where } \frac{1}{\lambda_i} = \frac{1}{\lambda + 0.08\beta} - \frac{0.035}{\beta^3 + 1} \quad (7)$$

Clearly the turbine speed has to be changed along with wind speed so that optimal tip speed ratio is maintained for maximum power capture and the Generator active power matches up to the output power of the turbine. This is shown in Fig.3 for various rotor speed and the maximal power of the turbine generator for each rotor speed occurs at the point where C_p is maximized.

To extract the maximum power generated, we must fix the

advance report λ_{opt} is the maximum power coefficient C_{p-max} , the measurement of wind speed is difficult, an estimate of its value can be obtained:

$$v_r = \frac{\omega_t R}{\lambda_{opt}} \quad (8)$$

The electromagnetic power must be set to the following

$$\text{value: } P_{-ref} = \frac{\pi}{2} C_{p-max} S \rho v_r^3 \quad (9)$$

From the electromagnetic power reference value, it is easy to determine the value of the electromagnetic torque setting:

$$C_{-ref} = P_{-ref} / \omega_t \quad (10)$$

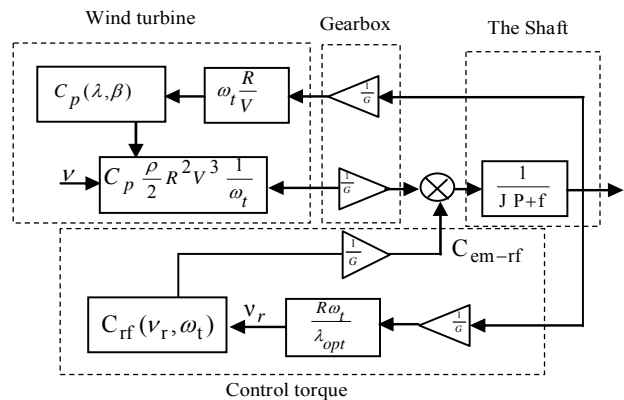

Fig .2 Wind turbine control

IV. MRAS ESTIMATION OF ROTOR SPEED AND POSITION

A MRAS estimator is used to estimate the rotational speed and rotor position of the DFIG and the structure for this estimator is depicted in Fig. 5. The MRAS estimator is the stator -flux error vector which is fed to the adaptation mechanism to ensure that the system will be stable and the estimated quantity will converge to the ideal (actual) value [1,2]:

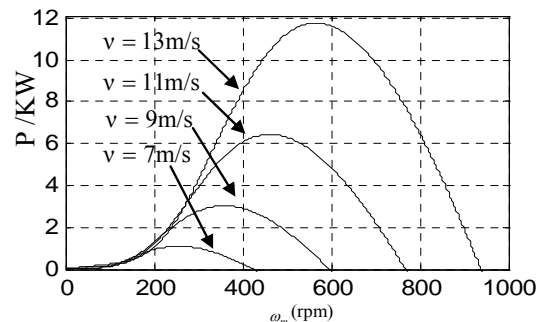

Fig.3 Wind Turbine Generator power- rotor speed characteristics

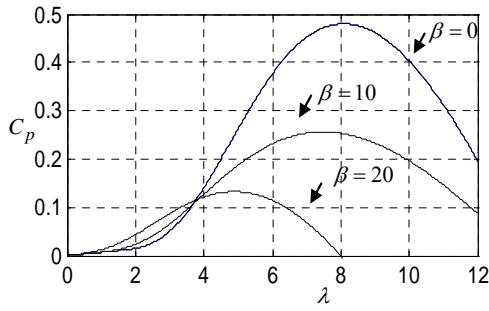
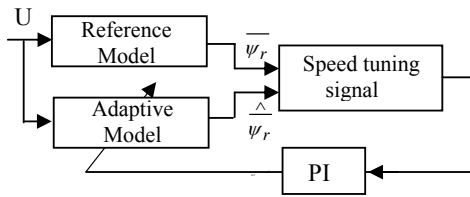

 Fig.4 Wind Turbine Generator $C_p - \lambda$ characteristics

Fig.5 MRAS scheme for estimation of the Speed

Where

$$\psi_r^s = \int (u_r - Rr i_r) dt \quad (11)$$

So we can get the estimated stator flux of adjustable model in the stator stationary coordinate by using rotor position:

$$\psi_r^r = \psi_r^s e^{j\theta_r} \quad (12)$$

In the MRAS method, it is possible to reduce the flux error between the reference and adjustable models through adjusting the rotor position.

The rotor speed can be then obtained as following:

$$e = \psi_r^s \otimes \psi_r^r = \psi_{r\alpha}^s \psi_{r\beta}^r - \psi_{r\beta}^s \psi_{r\alpha}^r \quad (13)$$

$$\hat{\omega}_r = k_p e + \int k_i e dt \quad (14)$$

The rotor electrical angle is obtained as:

$$\hat{\theta}_r = \int \hat{\omega}_r dt \quad (15)$$

V. DESIGN OF THE SLIDING MODE POWER CONTROL

The basic principle of the sliding mode control consists in moving the state trajectory of the system toward a surface $S(X) = 0$ and maintaining it around this surface with the switching logic function $Un V_n$. The basic sliding mode control law is expressed as.

$$V_c = V_{eq} + V_n \quad (16)$$

V_{eq} : is the equivalent control vector

V_n : is a sign function defined as $V_n = k \operatorname{sgn}(S(X))$ where:

$$\operatorname{sgn}(S(X)) = \begin{cases} 1 & \text{if } S(X) < 0 \\ -1 & \text{if } S(X) > 0 \end{cases} \quad (17)$$

After selecting the controlled states, the corresponding references are calculated according to the references of active and reactive power using the model of DFIG in (d-q) reference with the statoric flux vector aligned with d-axis

A. stator field oriented of the DFIG

Simplified expression of the electromagnetic torque is obtained by setting the following conditions:

$$\begin{cases} \psi_{qs} = \frac{d\psi_{qs}}{dt} = 0 \\ \psi_{ds} = \psi_s \end{cases} \quad (18)$$

The voltage equations and the flux equations of the stator can be simplified in steady state as:

$$\begin{cases} V_{ds} = 0 \\ V_{qs} = V_s \end{cases} \quad (19)$$

$$\begin{cases} \psi_s = L_s i_{ds} + M i_{dr} \\ 0 = L_s i_{qs} + M i_{qr} \end{cases} \quad (20)$$

From (18), the equations linking the stator currents to the rotor currents are deduced below:

$$\begin{cases} i_{ds} = \frac{\psi_s}{L_s} - \frac{M}{L_s} i_{dr} \\ i_{qs} = -\frac{M}{L_s} i_{qr} \end{cases} \quad (21)$$

Tacking into consideration the chosen reference frame, the active and reactive powers at the stator can be written as follows:

$$\begin{cases} P_s = \frac{3}{2} V_{qs} i_{qs} \\ Q_s = \frac{3}{2} V_{qs} i_{ds} \end{cases} \quad (22)$$

Replacing the stator currents by their expressions given in (11), the equations below are expressed:

$$\begin{cases} P_s = -\frac{3}{2} V_s \frac{M}{L_s} i_{qr} \\ Q_s = \frac{3}{2} V_s \left(\frac{\psi_s}{L_s} - \frac{M}{L_s} i_{dr} \right) \end{cases} \quad (23)$$

With this relations the stator active and reactive power.

The rotor fluxes and voltages can be written versus rotor currents as:

$$\begin{cases} \psi_{dr} = \left(L_r - \frac{M^2}{L_s} \right) i_{dr} + \frac{M V_s}{\omega_s L_s} \\ \psi_{qr} = \left(L_r - \frac{M^2}{L_s} \right) i_{qr} \end{cases} \quad (19)$$

$$\begin{cases} V_{dr} = R_r i_{dr} + \left(L_r - \frac{M^2}{L_s} \right) \frac{di_{dr}}{dt} - g \omega_s \left(L_r - \frac{M^2}{L_s} \right) i_{qr} \\ V_{qr} = R_r i_{qr} + \left(L_r - \frac{M^2}{L_s} \right) \frac{di_{qr}}{dt} + g \omega_s \left(L_r - \frac{M^2}{L_s} \right) i_{dr} + g \omega_s \left(\frac{V_s M}{\omega_s L_s} \right) \end{cases}$$

(20)

$$\text{With } g = \frac{\omega_s - \omega_r}{\omega_s}$$

B. stator Flux Estimator

Form of stator voltage equation shown (2) its derivation in the stationary reference frame ($\alpha - \beta$ reference frame) is given as follows:

$$\begin{cases} \psi_{\alpha s} = \int (V_{\alpha s} - R_s i_{\alpha s}) d\theta \\ \psi_{\beta s} = \int (V_{\beta s} - R_s i_{\beta s}) d\theta \end{cases} \quad (21)$$

The stator flux angle can be expressed as:

$$\theta_s = \arctan \frac{\psi_{\beta s}}{\psi_{\alpha s}} \quad (22)$$

C. Active and reactive power control

The paper designs the following sliding mode, let:

$$\begin{cases} S1 = P^* - P \\ S2 = Q^* - Q \end{cases} \quad (23)$$

where P^* and Q^* are the expected active power and reactive power reference.

The first order derivate of (23), gives:

$$\begin{cases} \dot{S}1 = -\dot{P} \\ \dot{S}2 = -\dot{Q} \end{cases} \quad (24)$$

Replacing the expression of the power by their expressions given in (18), the equations below are expressed:

$$\begin{cases} \dot{S}1 = \frac{3}{2} V_s \frac{M}{L_s} \dot{i}_{qr} \\ \dot{S}2 = \frac{3}{2} V_s \frac{M}{L_s} \dot{i}_{dr} \end{cases} \quad (25)$$

It takes the current expression of i_{dr}, i_{qr} , with the voltage equation (20) and tacking into consideration the sliding mode

in the steady state ($S = 0, \dot{S} = 0$). the equivalent control

vector V^{eq} can expressed by:

$$\begin{cases} V_{dr}^{eq} = -R_r \left(\frac{2}{3V_s} \left(\frac{L_s}{M} Q_s^* - \frac{\psi_{\beta s}}{L_s} \right) \right) - g\omega_s L_r (1-\sigma) \left(-\frac{2}{3V_s} \frac{L_s}{M} P_s^* \right) \\ V_{qr}^{eq} = -R_r \frac{2}{3V_s} \frac{L_s}{M} P_s^* + g\omega_s L_r (1-\sigma) \left(-\frac{2}{3V_s} \left(\frac{L_s}{M} Q_s^* - \frac{\psi_{\beta s}}{L_s} \right) \right) \\ \quad + g\omega_s \left(\frac{V_s M}{\omega_s L_s} \right) \end{cases} \quad (26)$$

the control vector is shown below: $V = V^{eq} + V^n$ V^n is the Sign function defined by: $V^n = -K \text{sign}(S)$ where K determine the ability of overcoming the chattering. In order to reduce the chattering phenomenon due to the discontinuous nature of the controller, a smooth function is defined in some neighbourhood of the sliding surface with a threshold as seen in Fig.6.

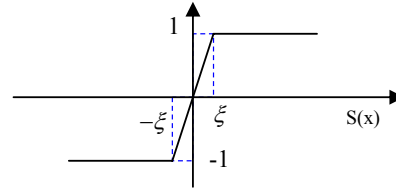

Fig. 6 Sketch of the saturation function

the global system can be obtained by add the mechanical device turbine as depicted in Fig.7.

VI. SIMULATION RESULTS

The structure of the wind power generation system shown as Figure 7, when the control system connecting to an infinite grid. The electrical parameter of a 7.5-kW DFM are : $P=2$, $R_r=0.7614\Omega, R_s=0.474\Omega, L_s=0.12H, M=0.107H, L_r=0.122H$.

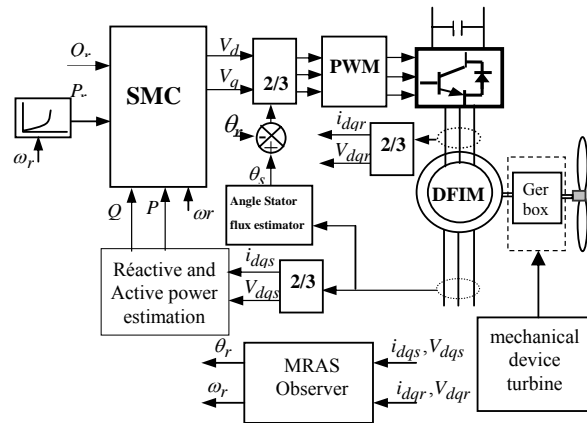

Fig.7 Sensorless sliding mode control scheme for a the DFIG.

The control system is implemented by Matlab/Simulink. And the results of simulation are shown in Fig.8-16.

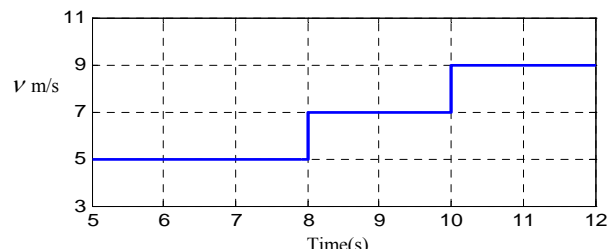

Fig. 8 Wind speed

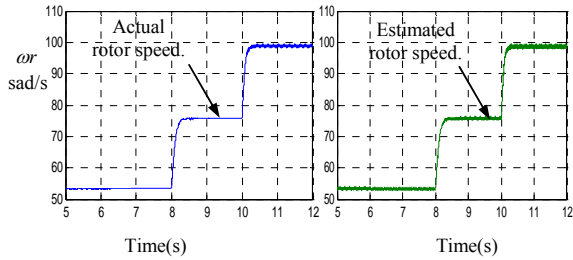

Fig.9 Optimal actual and estimated rotor speed.

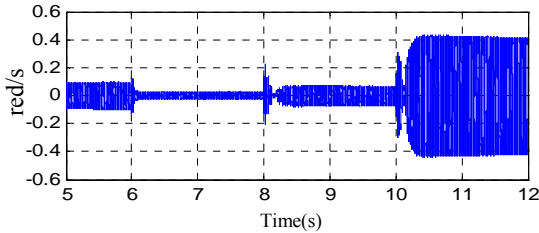

Fig.10 Error of rotor speed

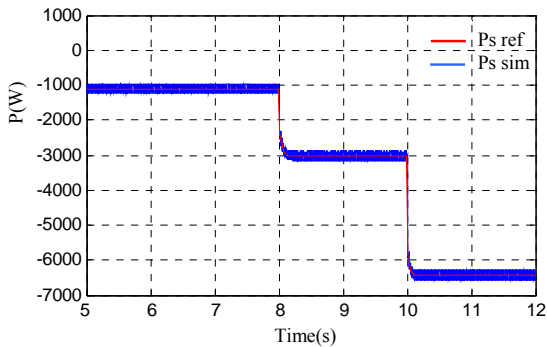

Fig.11 Results on stator active output power curve

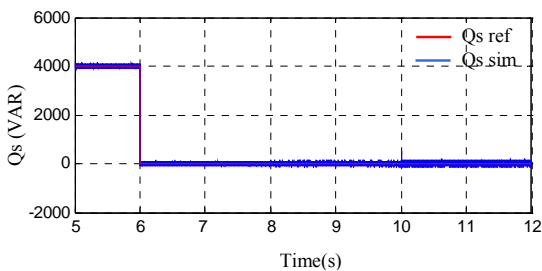

Fig.12 Results on responses to step changes in stator reactive power

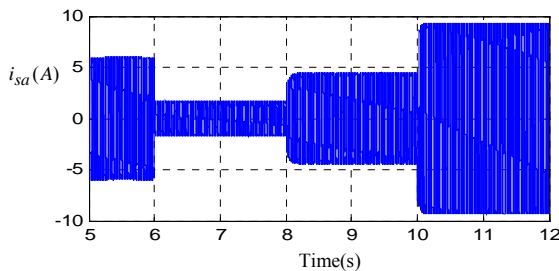

Fig.13 Phase sator current

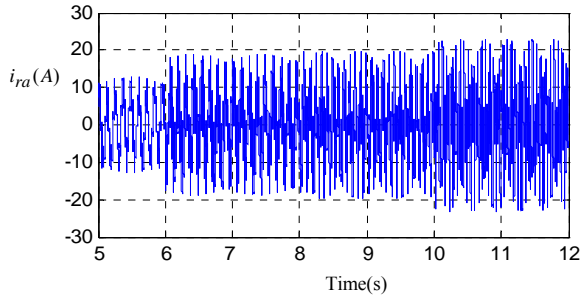

Fig.14 Phase rotor current

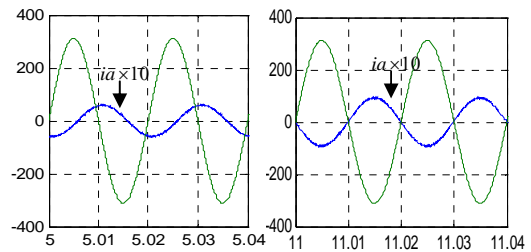

Fig.15 Zoom of phase stator current and voltage

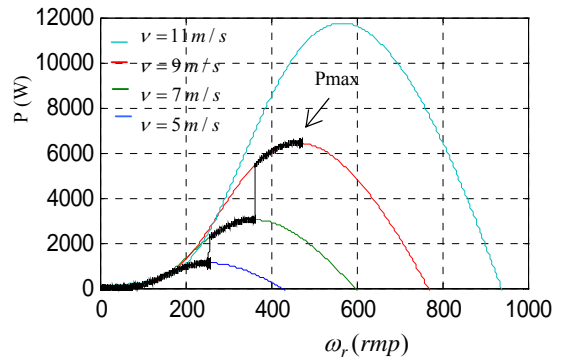

Fig.16 Wind turbine maximum power trajectory

For verify the robust of The dynamic performance of maximum power point tracking of the system proposed a step change in wind speed is simulated in Fig.(8) .The wind speed is start at 5m per second , at 8 second, the wind speed suddenly become 7m per second , as 10 second, the wind speed is 9 m per second.

Fig.9, Fig.10 respectively shows the performance of the MRAS observer tracking the rotational speed and the rotor speed error consequently it is indicated the tracking performance is excellent.

Fig 11 the stator power of DFIM accorder with the Wind turbine maximum power trajectory in Fig (16), these results realize the maximum wind energy tracking control .

For verify the decoupling between the active and reactive power a step change reactive power is simulated in Fig.(12), these figures represent a good pursuit its refineance and a very good decoupling .

Fig5 shows the DFIG stator current Its shows that, with the when the wind speed increases the amplitude of stator current

increased, but this phenomenon does not clear in the rotor current because of the discontinuous nature of the sliding control as seen in Fig.14.

VII. CONCLUSION

This paper has presented sensorless optimal control strategy of maximal wind energy tracking of doubly-fed induction generator in variable speed wind turbines application based MRAS observer, the decoupling between active and reactive is based on the robust sliding mode power control, the regulation of the active and reactive powers is directly without current controller used in the FOC drive and can provide fast dynamic response under transient conditions, simple structure and robust response.

REFERENCES

- [1] Cardenas, R. Pena, R. Proboste, J. Asher, G. Clare, J. "MRAS Observer for Sensorless Control of Standalone Doubly Fed Induction Generators" IEEE Transactions on Energy Conversion, Vol. 20, No 4, pp. 710 – 718,05 Dec 2005,
- [2] Yuan Guofeng; Li Yongdong; Chai Jianyun; Jiang Xinjian; "A Novel Position Sensor-less Control Scheme of Doubly Fed induction Wind Generator Based on MRAS Method" IEEE Power Electronics Specialists Conference, PESC .2008.,pp. 2723 – 2727.
- [3] Cardenas, R. Peia, J. Proboste, G. Asher, J. Clare "Sensorless Control of a Doubly- Fed Induction Generator for Stand Alone Operation" The 30th Annual Conference of the IEEE Industrial Electronics, 2004, pp. 0275-9306.
- [4] Pea, R, Cerdnas, R, Proboste, J, Asher, G., Clare, J"Sensorless Control of Doubly-Fed Induction Generators Using a Rotor-Current-Based MRAS Observer " IEEE Transactions on Industrial Electronics, Vol. 55, no. 1, pp. 330 - 339, January 2008.
- [5] Jiabing Hu , Heng Nian , Bin Hu, Yikang He "Direct Active and Reactive Power Regulation of DFIG Using Sliding-Mode Control Approach" IEEE Trans. Energy Convers., vol. 25, no. 4, pp. 1028 - 1039, Dec. 2010.
- [6] Xuemei Zheng, Lin Li, Dianguo Xu , Jim Platts "Sliding Mode MPPT Control of Variable Speed Wind Power System" Power and energy Conference,APPEEC 2009.
- [7] Hicham Serhoud, Djilani Benattous "Sensorless MPPT control of doubly fed induction wind generator based on MRAS observer"ICEEA'10 Bejaia, Algeria, 2-3 November 2010.
- [8] Hea-Gwang Jeong , Won-Sang Kim , Kyo-Beum Lee , Byung-Chang Jeong , and Seung-Ho Song "A Sliding-Mode Approach to Control the Active and Reactive Powers for A DFIG in Wind Turbines" IEEE ,Power Electronics Specialist Conference, 2008. PESC 2008.
- [9] Won-Sang Kim, Sung-Tak Jou , Kyo-Beum Lee , Steve Watkins "Direct Power Control of a Doudly Fed Induction Generator with a Fixed Switching Frequency" IEEE ,Industry Applications Society Annual Meeting, IAS '08, 5-9 Oct. 2008
- [10] Mohamed Machmoum, Frederic Poitiers "Sliding Mode Control of a Variable Speed Wind Energy Conversion System with DFIG" the International Conference and Exhibition on Ecological Vehicles and Renewable Energies, EVER 2009.
- [11] Djilali Kairous , René Wamkeue , Bachir Belmadani "Advanced Control of Variable Speed Wind Energy Conversion System with DFIG" Environment and Electrical Engineering (EEEIC), 2010 9th International Conference on, pp.41 - 44 ,16-19 May 2010.
- [12] Hicham Serhoud, Djilani Benattous" Modeling and Power Flow Control of a Brushless Doubly-Fed Generator " 6 th International Conference on Electrical Engineering, Batna 11 - 13 October 2010.
- [13] Dendouga, R. Abdessemed, M. L. Bendaas and A. Chaiba" Decoupled Active and Reactive Power Control of a Doubly-Fed Induction Generator (DFIG). Proceedings of the 15th mediterrance conference on control &Automation, july ,2007,Athens-Greece.
- [14] Cardenas, R. Peia, J. Proboste, G. Asher, J. Clare "Sensorless Control of a Doubly- Fed Induction Generator for Stand Alone Operation" The 30th Annual Conference of the IEEE Industrial Electronics, 2004, pp. 0275-9306.
- [15] Nait-kaci, B. Doumbia, M.L. Agbossou, K. Yousif, A. "active and reactive power control of a doubly fed induction generator for wind applications" IEEE EUROCON 2009,pp. 2034 – 2039.
- [16] Pea, R, Cerdnas, R, Proboste, J, Asher, G., Clare, J"Sensorless Control of Doubly-Fed Induction Generators Using a Rotor-Current-Based MRAS Observer " IEEE Transactions on Industrial Electronics, Vol. 55, no. 1, pp. 330 - 339, January 2008.
- [17] Ghennam,T. Berkouk, E.M. Francois, B. "modeling and control of a doubly fed induction generator (DFIG) based wind conversion system " IEEE Power Engineering, Energy And Electrical Drives Specialists Conference.,2009.,pp. 507 - 512.
- [18] D.Aouzellag, K.Ghedamsi , E.M.Berkouk "Network Power Flow Control of Variable Speed Wind Turbine" IEEE Power Engineering, Energy And Electrical Drives Specialists Conference.,2007.,pp. 435 – 439.
- [19] J. S. Thongam , P. Bouchard, H. Ezzaidi and M. Ouhrouche "Wind Speed Sensorless Maximum Power Point Tracking Control of Variable Speed Wind Energy Conversion Systems"IEEE Machines and Drives International Conference, 2009, pp. 1832 – 1837.
- [20] M.B.Mohamed, M.Jemli, M-Gossa, K. Jemli." Doubly fed induction generator (DFIG) in wind turbine modelling and power flow control " IEEE International Conference on Industrial Technology (ICIT), 2004.