

# Determination of Regimes of the Equivalent Generator Based on Projective Geometry: The Generalized Equivalent Generator

A. A. Penin

**Abstract**—Requirements that should be met when determining the regimes of circuits with variable elements are formulated. The interpretation of the variations in the regimes, based on projective geometry, enables adequate expressions for determining and comparing the regimes to be derived. It is proposed to use as the parameters of a generalized equivalent generator of an active two-pole with changeable resistor such load current and voltage which provide the current through this resistor equal to zero.

**Keywords**—equivalent generator, geometric circuits theory, circuits regimes, load characteristics, variable elements.

## I. INTRODUCTION

IN the theory of the electric circuits, in case of changeable parameters of the elements (loads, voltage regulators), one of the analysis problems is the establishment of the dependence of the changes of regime parameters on the respective change of an element parameter. It is important as well to determinate the values of regime parameters in relationship to, for example, the characteristic or maximum values. Practically, in the systems of power supplies, the load regime can vary largely from the reception to the return of the energy. Therefore, such a determination of regimes (hereinafter referred to as relative regimes) allows defining a degree of loading of the energy sources, to judge a current stock based on the various parameters, to compare the regimes of the different systems. The application of a number of well-known properties, theorems and methods essentially simplifies the decision problem in question. It is possible to refer to them a property of linearity between voltages and currents of various elements, the theorem of mutual increments of currents and changeable resistance, a method of the Thevenin and Norton equivalent circuits (equivalent generator) [1], [2]. However, the known approaches do not completely disclose the properties of such circuits, which reduces the efficiency of analysis.

A.A. Penin is with the Institute of Electronic Engineering and Industrial Technologies, Academy of Sciences of Moldova (e-mail: aapenin@mail.ru).

For example, let us assume that in the same system of power supplies, besides the basic (priority) load, there is also an auxiliary (buffer) load or the regulator of a voltage of load. In this case, a change of such an element leads to a change of the open circuit voltage, as a parameter of the known equivalent generator, which is inconvenient.

In a number of previous papers of the author, the approach based on an application of the projective geometry for interpretation of changes (kinematics) of regimes is discussed [3]-[5]. It allows revealing the invariant properties of circuits, i.e. such expressions, which turn out identical to all parameters of a regime, elements and circuit sites. Such invariant expressions can be assumed as basis of well-founded definition of relative regimes. The generalized equivalent generator theorem, which develops further the known Thevenin and Norton's theorems, is formulated. It appears that the load straight line at various values of a changeable element passes into a bunch of these lines. Since bunch coordinates do not depend on this changeable element, they can be accepted as the parameters of a generalized equivalent generator. The basic results are discussed further.

## II. DETERMINATION OF REGIMES OF THE EQUIVALENT GENERATOR: DISPLAY OF THE PROJECTIVE GEOMETRY

It is known that any linear circuit (an active two-pole)  $A$  relative to load terminals  $R_H$  is replaced by a voltage source  $U_0$  in series with a resistance  $R_i$  as shown in Fig.1 (Thevenin's theorem). Let two cases of change of elements  $R_H, R_i$  be considered.

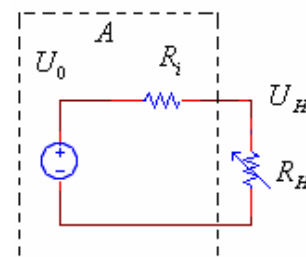

Fig. 1 Thevenin's equivalent circuits

Case 1.  $R_i = const$ . At change of load  $R_H > 0$  from a regime of short circuit SC ( $R_H = 0$ ) to the open circuit OC ( $R_H = \infty$ ), a load straight line or a I-V characteristic  $I_H(U_H)$  is obtained in Fig. 2:

$$I_H = \frac{U_0}{R_i} - \frac{U_H}{R_i} = I_M - \frac{U_H}{R_i}, \tag{1}$$

where  $I_M$  - the short circuit current .

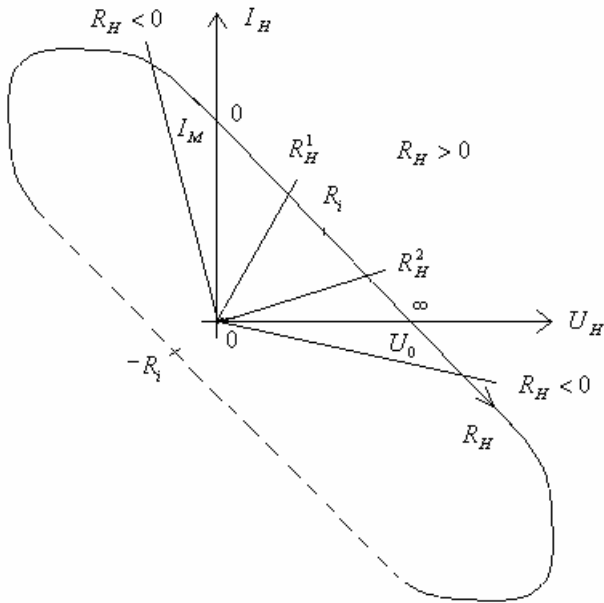

Fig. 2 I-V characteristic

A bunch of straight lines with the parameter  $R_H$  and the centre in a point 0 corresponds to this straight line. The unified equation of a bunch is given by [6]:

$$I_H = \frac{1}{R_H} U_H .$$

Further, it is possible to calibrate the I-V characteristic in values of load resistance. This internal area of change corresponds to a regime of energy consumption by the load. If to continue graduation for negative values  $R_H < 0$ , the regime passes into external area, which physically means a return of energy to a voltage source. Therefore, in an infinitely remote point  $R_H = -R_i$  graduations of the I-V characteristic will coincide for areas  $U_H > U_0, U_H < 0$ . Therefore, the straight line I-V characteristic is closed, which is characteristic of the projective geometry [7]. Further, the

equation  $U_H(R_H)$  has a characteristic linear - fractional view:

$$U_H = U_0 \frac{R_H}{R_i + R_H}. \tag{2}$$

It gives the grounds for considering the transformation of a straight line  $R_H$  (or I-V characteristic) into a straight line  $U_H$  as projective, which is in accordance with the positions of the projective geometry. Generally, the projective transformation of the points of one straight line into the points of the other is set by the centre of a projection  $S$  or three pairs of respective points in Fig. 3.

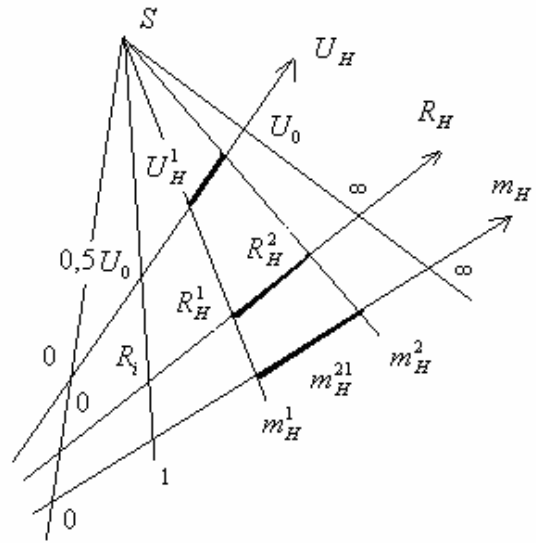

Fig. 3 Projective transformation of the straight lines points

As pairs of the respective points, it is convenient to use points of characteristic regimes, which can be easily determined at the qualitative level: short circuit, open circuit, maximum load power. The projective transformations preserve cross ratio of four points, where the fourth points are points of a running regime  $R_H^1, U_H^1, I_H^1$ :

$$\begin{aligned} m_H^1 &= (0 R_H^1 R_i \infty) \\ &= \frac{R_H^1 - 0}{R_H^1 - \infty} : \frac{R_i - 0}{R_i - \infty} = \frac{R_H^1}{R_i}, \\ m_H^1 &= (0 U_H^1 0,5U_0 U_0) = \frac{U_H^1}{U_0 - U_H^1}, \\ m_H^1 &= (I_M I_H^1 0,5I_M 0) = \frac{I_M - I_H^1}{I_H^1}. \end{aligned} \tag{3}$$

The cross ratio in geometry underlies the definition of a distance between points  $R_H^1, R_H = R_i$  concerning extreme or base values. The point  $R_H = R_i$  is a scale or a unit point. Thus, the coordinate of a point of a running regime is set by a number  $m_H$ , which is defined in an identical (invariant) manner through various parameters of a regime of  $R_H, U_H, I_H$  type. The regime change  $R_H^1 \rightarrow R_H^2$  can be expressed similarly:

$$m_H^{21} = (0 R_H^2 R_H^1 \infty) = \frac{R_H^2}{R_H^1} = \frac{U_H^2}{U_0 - U_H^2} : \frac{U_H^1}{U_0 - U_H^1} \quad (4)$$

The group properties of the cross ratio is given by:

$$m_H^2 = m_H^1 \cdot m_H^{21},$$

$$m_H^3 = m_H^2 \cdot m_H^{32} = m_H^1 \cdot m_H^{21} \cdot m_H^{32} = m_H^1 \cdot m_H^{31}.$$

Now, let it be necessary to set identical changes of a regime for different initial regimes on the straight line  $U_H$  in Fig. 4.

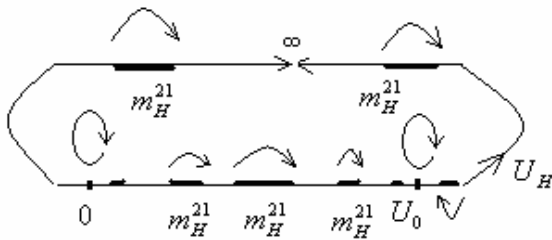

Fig. 4 Identical changes of a regime for different initial regimes

For this purpose, from (2) we receive an expression  $U_H^2 (U_H^1)$  explicitly, eliminating  $R_i$  for two values  $R_H^2, R_H^1$ :

$$\frac{U_H^2}{U_0} = \frac{m_H^{21} \cdot \frac{U_H^1}{U_0}}{(m_H^{21} - 1) \cdot \frac{U_H^1}{U_0} + 1} \quad (5)$$

The obtained transformation with a parameter  $m_H^{21}$  translates a point of an initial regime  $U_H^1$  into a point  $U_H^2$ . Therefore, by keeping a parameter of the transformation invariable and by setting different values of an initial regime  $U_{H1}^1, U_{H2}^1$ , etc., we obtain the points of the subsequent regimes  $U_{H1}^2, U_{H2}^2$ , etc., which form a segment of an invariable length (in sense of the projective geometry), which is considered as a segment movement in the geometry.

Here, the character of a change of Euclidean (usual) length of a segment is visible. Approaching to the base points, Euclidean length is decreasing to zero and then is increasing again at the moment of transition to external area. In the theory of the projective transformations, an important role is played by the fixed points, which can be accepted as the base points. For their finding the equation (5) is solved for a condition:  $U_H^1 = U_H^2$ . It turns out two real roots:  $U_H = 0, U_H = U_0$ , which defines the hyperbolic transformation and the hyperbolic (Lobachevsky) geometry, respectively. Physically, the fixed points mean such a regime, when such a parameter as  $U_H$  does not depend on the parameters of an element  $R_i$ . If roots of the equation coincide, one fixed point defines the parabolic transformation and, respectively, the parabolic (Euclidean) geometry. If roots are imaginary, the geometry is elliptic (Riemannian).

Proceeding from such a geometrical interpretation, it is possible to give the following definitions:

- the circuit's regime is a coordinate of a point on load straight lines and on axes of coordinates;
- the regime change is a movement of a point on all straight lines, which defines a segment of a corresponding length.

In this connection, one can accept the following requirements (similar to the metric spaces axioms):

- independence or invariance of regimes and their changes to the variables (regime parameters) as type  $R, U, I$ ;
- addition of regimes changes;
- possibility of the assignment of equal changes of a regime in various initial regimes.

*Special cases of projective transformations*

- As I-V characteristic is defined by a linear expression (1), in geometry, a similar expression defines an affine transformation in Fig.5. In addition, there is a projection centre  $S$ , but straight lines  $U_H, I_H$  are parallel.

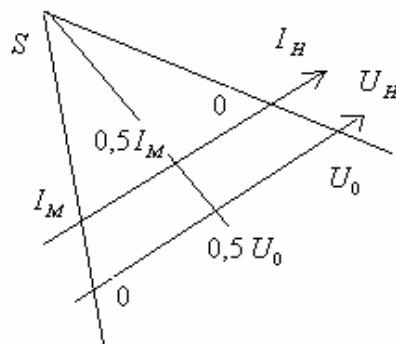

Fig. 5 Affine transformation

Therefore, an invariant of an affine transformation is a simple ratio or proportion  $n_H^1$  of three points:

$$n_H^1 = (0 \ U_H^1 \ U_0) = \frac{U_H^1 - 0}{U_0 - U_H^1},$$

$$n_H^1 = (I_M \ I_H^1 \ 0) = \frac{I_M - I_H^1}{I_H^1}.$$

Only two characteristic points are necessary for its statement, and various combinations or a record order is possible as well. If to express regimes changes, it turns out habitual “times” and “percents”.

-If the projection centre  $S \rightarrow \infty$ , the projection is carried out by parallel lines, which corresponds Euclidean transformation - parallel translation of a segment in Fig.6.

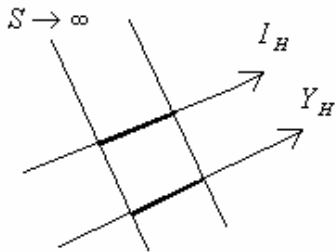

Fig. 6 Euclidean transformation

In a circuit, in this case  $R_i = 0$ , and the current is proportional to the conductivity of load  $Y_H$ . Therefore, the regime has only an absolute value since it is impossible to state a relative expression in view of the absence of a scale. Therefore, Euclidean transformation preserves the difference or the relation of currents values of initial and subsequent regimes. These two cases correspond to a known similarity [8].

In the geometry, it is established that these three kinds of transformations (projective, affine, Euclidean) exhaust the possible variants of group transformations which underlie the definition of the metrics of a straight line. Thus, the geometrical approach allows validating regimes determination, and both definitions of a regime and its change are coordinated by structure of expressions and ensure the performance of the group properties.

Case 2. Now, let both elements  $R_H, R_i$  be changed.

In this case, the I-V characteristic family or a bunch of straight lines  $R_i$  is obtained with the centre  $G$  in Fig.7. The unified equation of a bunch is given by [6]:

$$I_H = \frac{1}{R_i}(-U_H + U_0).$$

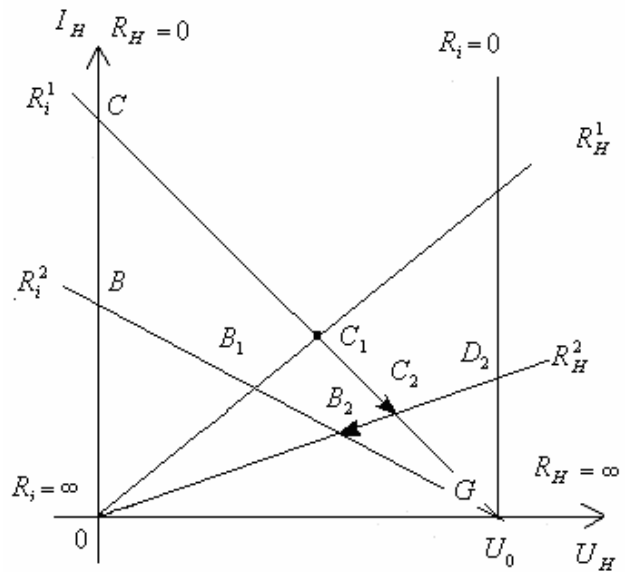

Fig. 7 I-V characteristic family

The coordinate of the centre  $G$  corresponding  $U_0$ , does not depend on values  $R_i$ . Physically, it means that the current through this element is equal to zero. The element  $R_i$  can accept such characteristic or base values, as  $0, \infty$ . The third characteristic value or a scale one is not present for  $R_i$ .

Let the relative regimes be considered for this case. Let internal resistance  $R_i$  be equal to  $R_i^2$ , and resistance of load varies from  $R_H^1$  to  $R_H^2$ . In this case, a point of an initial regime  $C_1 \rightarrow C_2$ . If  $R_i$  is equal  $R_i^1$ , a point of an initial regime  $B_1 \rightarrow B_2$ . Therefore, a change of a regime, which is determined by a change of the load (own change) is expressed similarly (4):

$$m_H^{21} = (C \ C_1 \ C_2 \ G) = (0 \ U_H(C_1) \ U_H(C_2) \ U_0) = (0 \ R_H^1 \ R_H^2 \ \infty) = (B \ B_1 \ B_2 \ G) \tag{6}$$

Similarly, a change of a regime, which is determined by a change of the  $R_i$  (mutual change):

$$m_i^{22} = (0 \ C_2 \ B_2 \ D_2) = (0 \ U_H(C_2) \ U_H(B_2) \ U_0) = (\infty \ R_i^1 \ R_i^2 \ 0) \tag{7}$$

In these expressions, identical basic points which are the centers of two bunches of straight lines  $R_H, R_i$  are used. If

regime is changed  $C_1 \rightarrow C_2 \rightarrow B_2$ , it is possible to speak about the general or compound change:  $m_H^{21} \cdot m_i^{22}$ .

Values for an initial  $m_H(C_1)$  and final regime  $m_H(B_2)$  are determined by (3). The above-mentioned arguments make it possible to confront the regimes of the compared circuits and to give a basis for an analysis of the general case of a circuit.

III. THE THEOREM OF THE EQUIVALENT GENERATOR OF AN ACTIVE TWO- POLE WITH CHANGEABLE ELEMENT

Let an active two-pole  $A$  with changeable resistance  $R_2$  be considered (for convenience of the mathematical description, the element  $R_2$  is taken out from a two-pole contour) and load  $R_H = R_1$  with voltage  $U_H = U_1$  in Fig. 8.

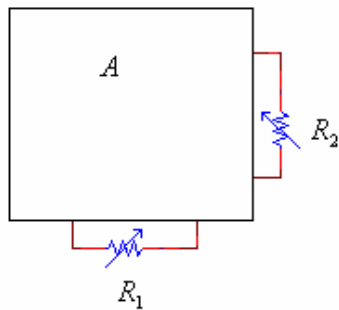

Fig. 8 Active two-pole  $A$  with changeable resistance  $R_2$  and load  $R_1$

The circuit equation (already as two-port network) through  $Y$ - parameters is given by:

$$I_1 = -Y_{11}U_1 + Y_{12}U_2 + I_1(SC, SC)$$

$$I_2 = Y_{21}U_1 - Y_{22}U_2 + I_2(SC, SC), I_2 = \frac{U_2}{R_2} \quad (8)$$

Currents of short circuit for both outputs:

$$I_1(SC, SC) = Y_{10}U_0$$

$$I_2(SC, SC) = Y_{20}U_0,$$

where  $U_0$ - resultant value of all voltage sources entering into an active two-pole.

The bunch equation is obtained from the system of the equations (8):

$$I_1 = U_1 \left( -Y_{11} + \frac{Y_{12}Y_{21}}{\frac{1}{R_2} + Y_{22}} \right) + U_0 \left( Y_{10} + \frac{Y_{12}Y_{20}}{\frac{1}{R_2} + Y_{22}} \right) \quad (9)$$

Setting various values  $R_2$ , we can receive an expression for a concrete load straight line which can be written as  $I_1 = I_1(U_1, R_2)$ . The variants of the position of a bunch  $R_2$  are shown in Fig. 9.

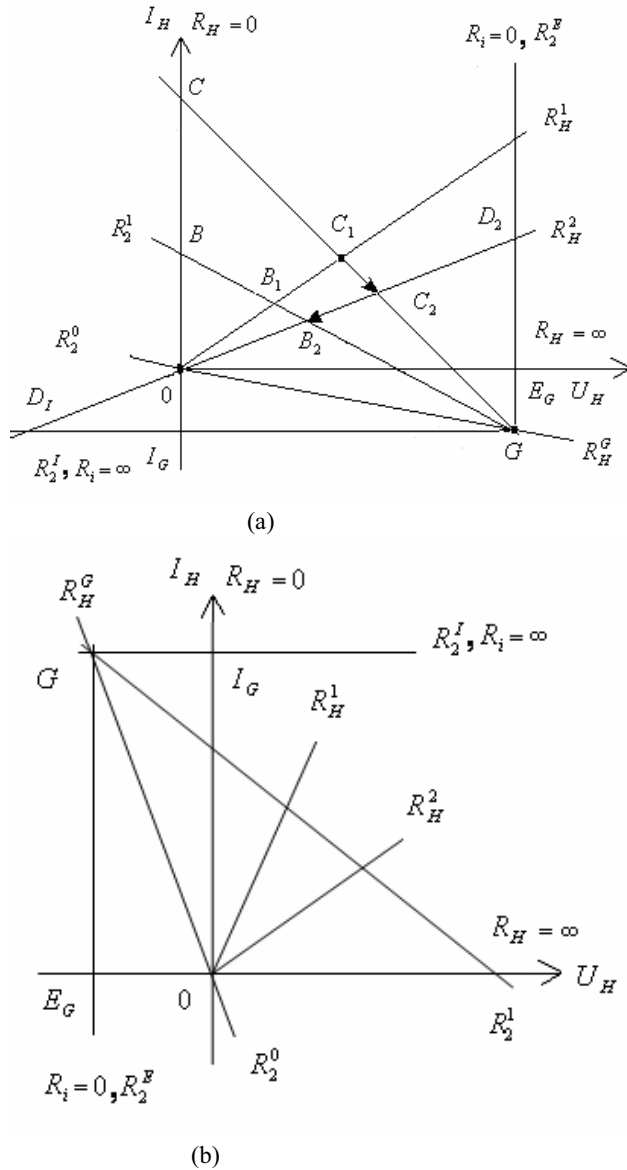

Fig. 9 The variants of the position of a bunch  $R_2$

The position of the centre  $G$  (in the second or the fourth quadrant) is stipulated by a kind of an energy source of a two-pole. If it is a voltage source, the case shown in Fig.9,a takes place. Such position of the centre results from a special case of the known equivalent generator, when a voltage open circuit does not depend on  $R_2$ . If the two-pole shows the properties of a current source in greater degree, the case shown in Fig.9,b takes place. Therefore, it is possible to

accept that the coordinates of the point  $G$  define already a generalized equivalent generator which circuits are shown in Fig.10.

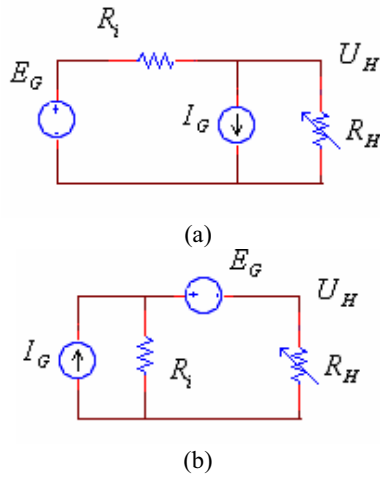

Fig. 10 A generalized equivalent generator

Besides the basic energy source of one kind (a voltage source  $E_G$ ), there is an additional energy source of another kind (a current source  $I_G$ ), which presents the contents of the corresponding theorem. The internal resistance  $R_i$  is determined by the known rules and corresponds to the first bracket (taken into account the sign) in the equation (9):

$$R_i = \frac{1}{Y_{11} - \frac{Y_{12}Y_{21}}{R_2 + Y_{22}}} = \frac{1 + Y_{22}R_2}{Y_{11} + (Y_{11}Y_{22} - Y_{12}Y_{21})R_2} \quad (10)$$

Physically, the bunch centre  $G$  corresponds to such a voltage  $E_G$  and a load current  $I_G$ , when the current through an element  $R_2$  is equal to zero. According to these conditions and to the equation (8), we can find the values of the parameters  $E_G$  and  $I_G$ :

$$I_G = U_0 \frac{Y_{11}Y_{20} + Y_{10}Y_{21}}{Y_{21}}, E_G = -U_0 \frac{Y_{20}}{Y_{21}}. \quad (11)$$

The value of a resistance of a load:

$$R_H^G = \frac{E_G}{I_G} = -\frac{Y_{20}}{Y_{11}Y_{20} + Y_{10}Y_{21}}. \quad (12)$$

The second characteristic value of the load is obtained besides value  $R_H = 0$ . Thus, a usual regime of an open circuit is not characteristic. From the equation (9) the unified record of a bunch [6] or the equation of the generalized equivalent is resulted:

$$I_H + I_G = -\frac{1}{R_i}(U_H - E_G)$$

The expression for a running or an initial regime  $m_H(C_1)$  already differs from (3):

$$m_H^1 = (0 R_H^1 R_i(R_2) R_H^G). \quad (13)$$

In its turn, the resistances  $R_2, R_i$  have the following characteristic values:

$$R_2^E = -\frac{1}{Y_{22}}, R_i = 0, \quad (14)$$

which defines an equivalent generator as an ideal voltage source;

$$R_2^I = \frac{-Y_{11}}{Y_{11}Y_{22} - Y_{12}Y_{21}}, R_i = \infty, \quad (15)$$

which defines an ideal current source ;

$$R_2^0 = \frac{-Y_{10}}{Y_{22}Y_{10} + Y_{12}Y_{20}}, R_i^0 = -\frac{E_G}{I_G} = -R_1^G, \quad (16)$$

which corresponds to a beam  $G0$  and defines the “zero-order” source, when a current and a voltage of a load are always equal to zero for all its values.

Thus, these three values form the basic values  $R_2^E, R_2^I$  and the scale value  $R_2^0$ . Therefore, it is possible to express a running value in a relative view through the corresponding cross ratio:

$$\begin{aligned} M_2^1 &= (D_2 B_2 0 D_1) = \\ &= (E_G U_H(B_2) 0 U_H(D_1)) = \\ &= (R_2^E R_2^I R_2^0 R_2^I) = (0 R_i^1 R_i^0 \infty) \end{aligned} \quad (17)$$

It allows one to compare the different circuits and to define (concerning own scales) in what degree properties of a voltage source and a current source (or what condition of an active two-pole) are shown. If value of  $R_2$  is approximated to  $R_2^E$ , we get a voltage source with  $M_2, R_i \rightarrow 0$ .

Also we can define:

the own change of a regime similarly to (6):

$$\begin{aligned} m_H^{21} &= (C C_1 C_2 G) = \\ &= (0 U_H(C_1) U_H(C_2) E_G) = \\ &= (0 R_H^1 R_H^2 R_H^G) = (B B_1 B_2 G) \end{aligned} \quad (18)$$

the mutual change of a regime similarly to (7):

$$\begin{aligned} m_2^{22} &= (0 C_2 B_2 D_2) = \\ &= (0 U_H(C_2) U_H(B_2) E_G) = \\ &= (\infty R_1^1 R_1^2 R_1^E) \end{aligned} \quad (19)$$

The identical basic points, which are the centers of two bunches of the straight lines, the points  $O, G$ , are used in these expressions.

These considerations allow defining the equivalence or the similarity of the different circuits and their regimes. The straight line bunches for the two circuits are given in Fig.11. The arrows show the correspondence of straight lines of identical regimes. Such a mapping of bunches is described by a projective transformation, which preserves the above shown (17, 18, 19) cross ratio. The equality of the correspondence cross ratio for the compared circuits is a condition of the equivalence.

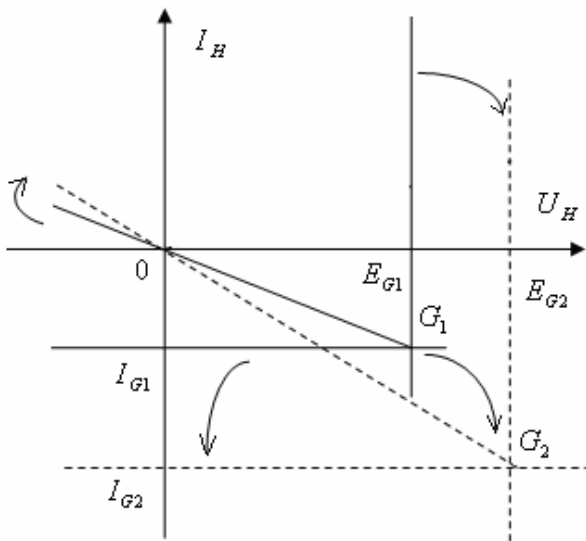
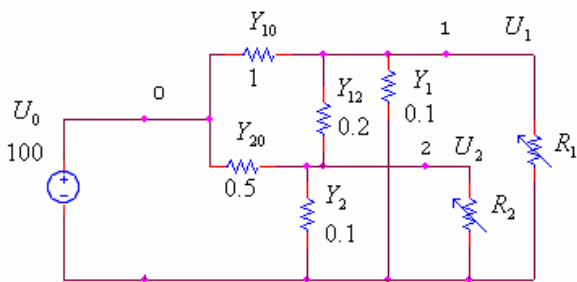

Fig. 11 The correspondence of straight lines of identical regimes of the different circuits

IV. EXAMPLES

To clarify the presented results let us consider the relevant examples.

Example 1. Let us consider the circuit with a changeable resistance  $R_2$  (buffer load) and a load  $R_H = R_1$  in Fig.12a.



(a)

The circuit equation is given by:

$$I_1 = -1.3U_1 + 0.2U_2 + 1 \cdot 100$$

$$I_2 = 0.2U_1 - 0.8U_2 + 0.5 \cdot 100$$

where:  $Y_{11} = 1.3 = Y_1 + Y_{10} + Y_{12}$ ,

$Y_{22} = 0.8 = Y_2 + Y_{20} + Y_{12}$ ,

$Y_{12} = 0.2, Y_{10} = 1, Y_{20} = 0.5$ .

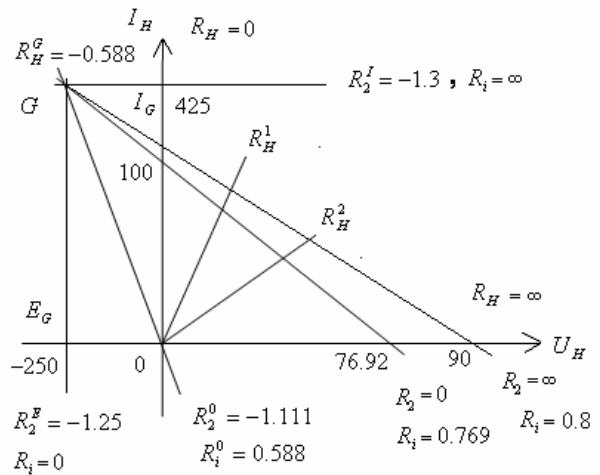

(b)

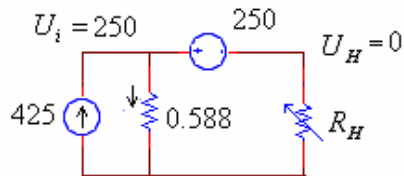

(c)

Fig. 12 The circuit with a changeable resistance  $R_2$  (buffer load) and a load  $R_H = R_1$

We define the coordinates of the center of the bunch  $G$  from (11):

$$I_G = 100 \frac{1.3 \cdot 0.5 + 0.2 \cdot 1}{0.2} = 425$$

$$E_G = -100 \frac{0.5}{0.2} = -250.$$

Therefore, the equivalent generator corresponds to Fig.10,b. Value dimensions are not indicated for simplifying the record. The corresponding value of the load resistance is:

$$R_H^G = \frac{E_G}{I_G} = -\frac{250}{425} = -0.588.$$

We define all the characteristic elements and values from (14, 15, 16):

$$R_2^E = -\frac{1}{0.8} = -1.25, R_i = 0;$$

$$R_2^I = \frac{-1.3}{1.3 \cdot 0.8 - 0.2 \cdot 0.2} = -1.3, R_i = \infty,$$

$$R_2^0 = \frac{-1}{0.8 \cdot 1 + 0.2 \cdot 0.5} = -1.111, R_i^0 = 0.588.$$

The areas of positive and negative values for these elements are visible clearly in Fig.12,b. The Fig.12,c presents the equivalent generator circuit that demonstrates the "mechanism" of the "zero-order" generator, when  $R_i = R_i^0 = 0.588$ . The load voltage is always equal to zero for this value of the internal resistance since  $U_i = I_G \cdot R_i = 250 = -E_G$ .

*Example 2.* Let us consider the circuit with a changeable resistance  $R_1$  (a load voltage regulator) in Fig.13.a.

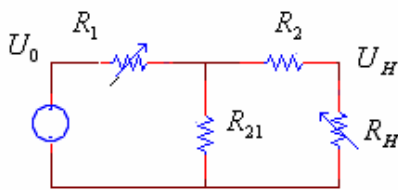

(a)

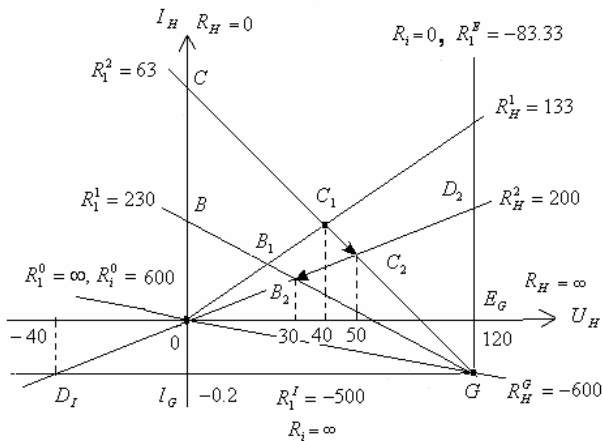

(b)

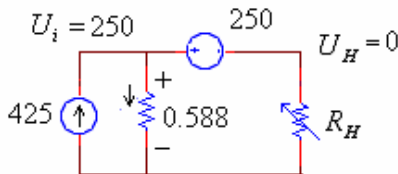

(c)

$\infty$	600	257	156	100	0	$R_i$
$\infty$	1	0.428	0.259		0	$M$
-500	$\infty$	230	63	0	-83.33	$R_1$
		$B_2$	$C_2$			$D$
-40	0	30	50		120	$U_H$

(d)

Fig. 13 The circuit with a changeable resistance  $R_1$

We define the coordinates of the center bunch  $G$  :

$$E_G = U_0 \frac{R_2 + R_{21}}{R_{21}} = 100 \frac{100 + 500}{500} = 120$$

$$I_G = -\frac{U_0}{R_{21}} = -\frac{100}{500} = -0.2$$

Therefore, the equivalent generator corresponds to Fig.10.a. The corresponding value of the load resistance:

$$R_H^G = \frac{E_G}{I_G} = -(R_2 + R_{21}) = -600.$$

The expression for the internal resistance:

$$R_i = R_2 + \frac{R_1 \cdot R_{21}}{R_1 + R_{21}}.$$

We define all the characteristic values of the elements

$R_1$  and  $R_i$  :

$$R_1^E = -\frac{R_2 \cdot R_{21}}{R_2 + R_{21}} = -83.33, R_i = 0;$$

$$R_1^I = -R_{21} = -500, R_i = \infty,$$

$$R_1^0 = \infty, R_i^0 = R_2 + R_{21} = 600.$$

The areas of the positive and negative values for these elements are clearly shown in Fig.13,b. The Fig.13,c presents the equivalent generator circuit that demonstrates the "mechanism" of the "zero-order" generator. We define the cross ratio (17) for two values  $R_1^1 = 230, R_1^2 = 63$  and  $R_H^2 = 200$ , which corresponds to the points  $B_2, C_2$  :

$$M_1^1 = (D_2 B_2 0 D_1) = (E_G U_H(B_2) 0 U_H(D_1)) =$$

$$= (120 \ 30 \ 0 \ -40) = \frac{30 - 120}{30 + 40} \div \frac{120}{-40} = 0.428$$



## REFERENCES

$$M_1^2 = (D_2 \ C_2 \ 0 \ D_I) = (E_G \ U_H(C_2) \ 0 \ U_H(D_I)) =$$

$$= (120 \ 50 \ 0 \ -40) = \frac{50-120}{50+40} \div \frac{120}{-40} = 0.259$$

The obtained values are represented in Fig.13,d, where the correspondence of the points of all the straight lines  $R_1, R_i, D, U_H, M$  is shown. If the value of  $R_1$  is approximated to  $R_1^E = -83.33$ , a voltage source is turned out with  $M_1, R_i \rightarrow 0$ .

Let the load regime be changed as follows:  
 $C_1 \rightarrow C_2 \rightarrow B_2$

Then, the own change of the regime is:

$$m_H^{21} = (C \ C_1 \ C_2 \ G) = (0 \ U_H(C_1) \ U_H(C_2) \ E_G) =$$

$$(0 \ 40 \ 50 \ 120) = 0.7,$$

the mutual change is:

$$m_1^{22} = (0 \ C_2 \ B_2 \ D_2) = (0 \ U_H(C_2) \ U_H(B_2) \ E_G) =$$

$$(0 \ 50 \ 30 \ 120) = 2.14,$$

the total change is:

$$m_H^{22} = (C \ C_1 \ B_2 \ G) = (0 \ U_H(C_1) \ U_H(C_2) \ E_G) =$$

$$(0 \ 40 \ 30 \ 120) = 1.5 = 0.7 \cdot 2.14$$

## V. CONCLUSION

1. The projective geometry adequately interprets "the kinematics" of a circuit with the changeable parameters of elements, allows to carry out a more in-depth analysis and to obtain a relationship useful in practice.
2. From the methodological point of view, the presented above approach is applied in other scientific domains as the mechanics (the principles of the special relativity), the biology (the principles of age changes of plants and organisms).
3. The proposed approach can be applied in particular to:
  - linear circuits AC;
  - circuits with sources and consumers of power;
  - adjustable voltage converters with supplies of limited power.

- [1] G. E. Chatzarakis, P. G. Cottis, M. D. Tortoreli, P. B. Malatestas, N. J. Kolliopoulos and S. N. Livieratos, "Powerful pedagogical approaches for finding Thevenin and Norton equivalent circuits for linear electric circuits", *Intl. J. Elect.Enging. Educ.*, 42/4 (Oct.2005), pp. 350-368.
- [2] C. A. Desoer and E. S. Kuh, *Basic Circuit Theory*. McGraw - Hill, New York, 1969.
- [3] A. A. Penin, "Linear- fractional relation in the problems of analysis of resistive circuits with variable parameters", *Electrichestvo*, 11, 1999, pp. 32- 44, (russian).
- [4] A. A. Penin, "Characteristics modified equivalent generator of active two- terminal network with variable resistor", *Electrichestvo*, 4, 1995, pp. 55- 59, (russian).
- [5] A. A. Penin, "Projective equivalency of operating conditions for two- ports", *Electrichestvo*, 8, 1993, pp. 47- 54, (russian).
- [6] G. A. Korn and T. M. Korn, *Mathematical Handbook*. McGraw - Hill, New York, 1968.
- [7] O. Veblen and J. W. A. Young, *Projective Geometry*, vol.1. Blaisdell, New York, 1938- 1946.
- [8] V. A. Venikov, *Similarity and Simulation Theory*. Higher School, Moscow, 1976, (russian).