

Differential Protection for Power Transformer Using Wavelet Transform and PNN

S. Sendilkumar, B. L. Mathur, and Joseph Henry

Abstract—A new approach for protection of power transformer is presented using a time-frequency transform known as Wavelet transform. Different operating conditions such as inrush, Normal, load, External fault and internal fault current are sampled and processed to obtain wavelet coefficients. Different Operating conditions provide variation in wavelet coefficients. Features like energy and Standard deviation are calculated using Parsevals theorem. These features are used as inputs to PNN (Probabilistic neural network) for fault classification. The proposed algorithm provides more accurate results even in the presence of noise inputs and accurately identifies inrush and fault currents. Overall classification accuracy of the proposed method is found to be 96.45%. Simulation of the fault (with and without noise) was done using MATLAB AND SIMULINK software taking 2 cycles of data window (40 m sec) containing 800 samples. The algorithm was evaluated by using 10 % Gaussian white noise.

Keywords—Power Transformer, differential Protection, internal fault, inrush current, Wavelet Energy, Db9.

I. INTRODUCTION

POWER transformers are important equipment in the power system and its protection scheme is of vital significance to provide continuous power supply ensuring reliable operation. When the power transformer is switched ON, the remnant flux in the transformer draws the large current from the source this current is usually ten times that of the full load current. It persists only for a very short duration and decays very quickly, which is very high magnitude causes the relay to operate falsely. Hence, such inrush current needs to be discriminated from the internal fault to prevent mal operation. Earlier, Harmonic restraint techniques were used which discriminates inrush current from internal fault using second harmonic component [1]. Sometimes, the second harmonic component may be generated in the case of internal faults in the power transformer and this is due to current transformer (CT) saturation or presence of a shunt capacitor or the distributive capacitance in a long extra high voltage transmission line to which the transformer may be connected [2,3]. Inrush current will have dominant second harmonic component compared to internal fault. However, with improvement in transformer design, this second harmonic component is highly reduced and it was complex to discriminate using harmonic restraint techniques [4]. For the above foregoing problem,

S.Sendilkumar is with the Electrical Engineering Department, St Peter's Engineering College, Avadi, Annauniversity, Chennai, Chennai-600054, Tamilnadu, India, phone:91-26558080 (e-mail:sendilkumar2009@gmail.com)

B.L.Mathur is with SSN college of Engineering, Electrical Engineering Department, Kalavakkam, Annauniversity, Chennai-603110, Tamilnadu, India (e-mail:blmathur@ssn.edu.in)

Joseph Henry is with VELTECH University, Electrical Engineering Department, Chennai-601206, Tamilnadu, India (e-mail:joseph_henry@rediffmail.com)

neural network and fuzzy logic techniques have also been used to detect the internal faults. In first approach [5,6] differential current harmonics were used as input to train neural network, which require large training set, large training time and design of new neural network for other transformer system having different voltage ratios and kVA rating. In another approach, fuzzy logic technique has been proposed [7, 8]. The method requires the design new rules for every cases, Suffered from hard thresholding, which makes difficult for discrimination between faults and non faults and it is highly dependent on transformer parameters. To overcome the above limitations, wavelet transform is required. In this paper, we proposed using wavelet transform combined with PNN is proposed. Wavelet algorithm has been used for analyzing power system transients [9]. In [10-12] authors have used discrete wavelet transform for differential protection. In another approach [13] have used wavelet packet algorithm to extract certain features of the differential current like maximum description length, optimal wavelet and optimal levels of resolution. In [14, 15] authors have discriminated inrush and fault currents using wavelet coefficients and wavelet energy. Results are also compared with various mother wavelets. Feature extraction of differential current is also needed to reliably distinguish inrush and fault currents. In [16-18] authors have extracted these features using wavelet transform and neural network. In [19, 20] have utilized wavelet transform for feature extraction and ANFIS (adaptive neuro fuzzy inference system).

From the above reported literature [10-20], the variations of detailed coefficients are used to distinguish between magnetizing inrush current and fault current. In [21], a pattern recognition approach based on S-transform has been developed for differential protection of power transformer.

A new technique for discriminating between inrush current and internal fault current is presented in this paper by combining wavelet transform and neural network. Initially wavelet transform is applied to decompose the differential currents signals in to series of wavelet coefficients. DB9 has been used as mother wavelet function [22]. Using Parsevals theorem energy is retrieved from level D1 to D5 to obtain energy vector. PNN has been tested and trained using features of energy vector for fault classification.

II. TRANSIENT ANALYSIS BASED ON WAVELET TRANSFORM

Wavelet transform is a powerful signal processing tool used in power system analysis. The wavelet transform (WT), like the short time Fourier transform (STFT), allows time

localization of different frequency components of a given signal, however with one important differences STFT uses a fixed width windowing function. As result, both frequency and time resolution of the resulting transform will be a prior fixed but in the case of wavelet transform, the analyzing functions, which are called wavelet, will adjust their time widths to their frequency in such a way that, higher frequency wavelets will be very narrow and lower frequency wavelets will be wide. It has been found using wavelet for the proposed power system model it shows for internal fault currents window is narrow; for inrush, current window is very wide. It can be defined as follows:

$$f(x) = \sum_{i,j} \Psi_{i,j}(x) \quad (1)$$

Where i and j are integers, the functions $\Psi_{i,j}(x)$ are the wavelet expansion functions and the two parameters expansion coefficients $a_{i,j}$ are called the discrete wavelet transform (DWT) coefficients of $f(x)$. The coefficients are given by

$$a_{i,j} = \int_{-\infty}^{+\infty} f(x)\Psi_{i,j}(x) \quad (2)$$

The wavelet basis functions can be computed from a function $\Psi_{i,j}(x)$ called the generating or mother wavelet through translation and scaling (dilation) parameters

$$\Psi_{i,j}(x) = 2^{-i/2}\Psi(2^{-i}x - j) \quad (3)$$

Where j is the translation parameter and i is the scaling parameters. Mother wavelet function is not unique, but it must satisfy a small set of conditions. One of them is Multiresolution condition and related to the two-scale difference equation

$$\phi(x) = \sqrt{2} \sum_k h(k)\phi(2x - k) \quad (4)$$

Where $\phi(x)$ is scaling and $h(k)$ must satisfy several conditions to make basis wavelet functions unique, orthonormal and have a certain degree of regularity. The mother wavelet is related to the scaling function as follows:

$$\Psi(x) = \sqrt{2} \sum_k g(k)\phi(2x - k) \quad (5)$$

Where $g(k) = (-1)^k h(1 - k)$. At this point, if valid $h(x)$ is available, one can obtain $g(x)$. Note that h and g can be viewed as filter coefficients of half band low-pass and high-pass filters, respectively. J-level wavelet decomposition can be computed with (6) as follows:

$$f_0(x) = \sum_k a_{0,k}\phi_{0,k}(k) = \sum_k a_{j+1,k}\phi_{j+1,k} + \sum_{j=0}^J d_{j+1,k}\Psi_{j+1,k}(x) \quad (6)$$

Where coefficients a_0, k and coefficients $a_{j+1, n}$ and $d_{j+1, n}$ at scale $j + 1$ are given.

Multiresolution analysis leads to a hierarchical and fast scheme. This can be implemented by a set of successive filter banks. Fig.1 illustrates the implementation procedure for discrete wavelet transform in which $X(n)$ is the original signal, $h(n)$ and $g(n)$ are low pass filter and high pass filter respectively. At the first stage, an original signal is divided

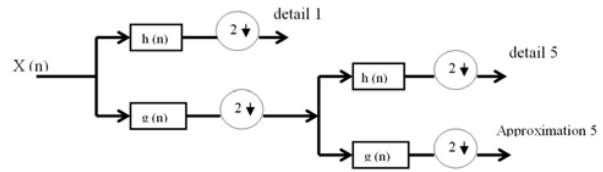

Fig. 1. Decomposed levels of DWT

into two halves of the frequency bandwidth and sent to both HPF and LPF then the output of the LPF is further cut in half of the frequency bandwidth and sent to the second stage, this procedure is repeated until the signal is decomposed to a predefined certain level.

In this paper, transformer different operating conditions are decomposed to five levels; a5 is the approximation level containing the fundamental frequency component and d1 to d5 are detail levels with high frequencies. The ninth order Daubechies (db9) wavelet filter was used for wavelet decomposition.

Wavelet transform has been found very efficient in discrimination of inrush current and fault current by many authors [10-20]. Application of wavelet transform has been used in many power engineering applications like power quality [23], transmission line fault analyze[24], also in various other fields like ECG signal analysis [25], automotive generator fault [26], Engine fault analysis [27]. It has ability to analyze the local discontinuous of signals. Wavelet transform has a special feature that they have variable window size, being wide for low frequencies that exist for inrush current and narrow for high frequencies occurred form internal fault current.

III. APPLICATION OF PARSEVAL'S THEOREM AND FEATURE EXTRACTION

The energy of signals that go through DWT decomposition can be described by

$$\frac{1}{N} \sum_T |x(t)|^2 = \frac{1}{N_j} \sum_h |cA_{j,h}|^2 + \sum_{j=1}^J \left(\frac{1}{N_j} \sum_h |cD_{j,h}|^2 \right) \quad (7)$$

Where N is the sampling period. The First and second term on the right of equal sign denotes the average power of the approximated version and detailed version, and the left term of equal sign represents the total energy. In the present study, the energy distributions for different operating conditions are divided in to one level for the approximate version and five for the detailed version. The coefficient cA of approximate version and coefficient cD of the detailed version are employed to extract the feature of signals from different operating conditions.

In order to investigate the applicability of the proposed algorithm, a detailed simulation study has been carried out on power system model shown in the Fig.2 The source is simulated by an equivalent 50 Hz 450 MVA Synchronous machines with 500 MVA transformer and 100 MW load is connected in parallel. A (500/230) kV star to delta connected transformer is employed with its neutral grounded. The CTs

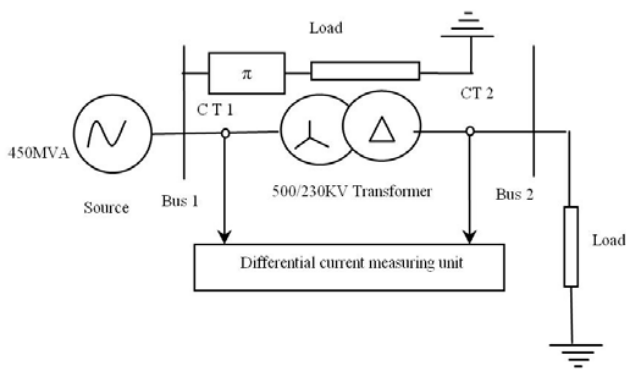

Fig. 2. Power system Model

used in the primary side is delta connected and star connected in the secondary side. The relay unit is connected to the CTs on both HV and LV sides of the transformer. The sampling rate of 20 kHz is considered. The cycle contains 800 samples per power frequency band at 50Hz. The generator X/R ratio is 10. The primary winding voltage $R(pu)$ and $L(pu)$ are 500 kV.0.0078 and 0.259 respectively, and secondary winding voltage is $R(pu)$ and $L(pu)$ are 230 kV.0.0078 and 0.259 respectively. The simulation model are developed using MATLAB-SIMULINK software modules. The load taken here is 100 MW and 80 MVAR.

IV. PROPOSED APPROACH

The proposed approach is shown as in Fig 3. Different operating conditions in power transformer are normal current, magnetizing inrush current, phase to phase fault, phase to ground fault and three phase faults all the above for with and without load are generated using simulation model shown in Fig.2 are processed to wavelet transform then above operating signals are scaled to level 1 to 5. Using Parsevals theorem energy has been calculated; simulated operating conditions have different characteristic that has been taken for consideration. Features extracted from operating conditions for with and without load are listed in Table.1. It has been observed from the Table.1 that Energy extracted for inrush current is lesser compared to internal faults. First, Using power system model shown in the Fig signals are generated for different operating conditions are decomposed for different frequency levels (d1 to d5) using Db9 mother wavelet transform. For feature extraction, Parsevals theorem has been used. Next, classification of inrush current and internal fault current has been performed using PNN based on Testing and Training features that extracted from wavelet coefficients.

V. SIMULATION RESULTS

The proposed simulation model has been studied for different cases like Inrush current, external fault on transmission line, Single line to ground fault, Double line to ground fault, and three phase fault for power transformer with load, without load and presence of noise.

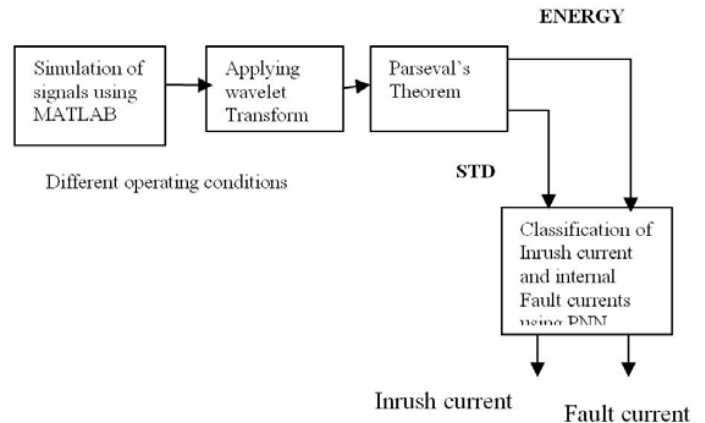

Fig. 3. Block diagram for the proposed

In this paper following cases are proposed 1) Magnetizing inrush current with no load, 2) Single line to ground fault with no load

A. Case. 1 Magnetizing Inrush Current, no load

The Figs.4 shows inrush current with no Load for Phase a. Figs.3 a) differential current from Current transformer 5000 samples, as the simulation time is 0.25 seconds and sampling frequency is 20 kHz.,b) sampled signals each 400. c) Expansion of wavelet coefficients for inrush current. Using, wavelet transform windows are very wide for low frequencies. This feature has been found from inrush current after the wavelet transform.

B. Case.2 Single line to ground fault, no load

Figs.5 shows the single line to ground fault for phase a. differential current and current samples. From the amplitudes of wavelet coefficients, it is noted that windows are very narrow for high frequency transients. The tripping signal is issued using energy vector computed from parsevals theorem.

VI. PROPOSED ALGORITHM USING WAVELET TRANSFORM

The proposed protection algorithm is implemented in MATLAB environment. The program developed receives sampled current data of the simulated faults from the power system shown in the Fig.2

Referring to the relay flow chart shown in the Fig.6.

Step.1 Obtain three phase differential currents using CTS and 800 samples of differential current is sampled.

Step.2 Applying the wavelet transform for samples of differential current.

Step.3 Energy and STD is calculated from approximation and details using Parsevals theorem to obtain energy vector for tripping operation energy vector is calculated as

$$\text{Energy vector} = E_{d1} + E_{d2} + E_{d3} + E_{d4} + E_{d5} + A_5$$

TABLE I
ENERGY AND STANDARD DEVIATION VALUES FOR DIFFERENT OPERATING CONDITIONS

INRUSH/ FAULT	WITHOUT LOAD				WITH LOAD			
	Training Data		Testing Data		Training Data		Testing Data	
	Energy	STD	Energy	STD	Energy	STD	Energy	STD
Normal	0.1339	0.0020	8.5488	0.0136	585.28	0.1504	595.70	0.1425
Inrush a	597.55	0.1427	0.1438	0.0024	480.31	0.1337	493.93	0.1252
Inrush b	594.32	0.1427	0.1299	0.0025	699.53	0.2011	709.84	0.1937
Inrush c	592.25	0.1431	0.1399	0.0023	1214.4	0.2690	1219.7	0.2603
Internal Faults								
Fault a-g	8659.4	0.7840	8648.5	0.7747	7518.5	0.7162	7516.2	0.7072
Fault b-g	5545.1	0.5103	5561.4	0.5038	4941.9	0.5399	4960.0	0.5315
Fault c-g	5462.1	0.5811	5450.2	0.5709	3866.9	0.9614	3890.0	0.4549
Fault ab-g(a)	12794	0.8850	12810	0.8807	12810	0.8807	1242.7	0.8774
Fault ab-g(b)	4656.4	0.4200	4676.5	0.4135	4676.5	0.4135	5865.4	0.5465
Fault bc-g(b)	7573.6	0.5487	7607.6	0.5416	7601.6	0.5416	7613.2	0.7020
Fault bc-g(c)	6973.1	0.7103	6981.3	0.7023	6981.3	0.7023	5390	0.6992
Fault ac-g(a)	8218.8	0.7351	8195.0	0.7249	6869.1	0.6181	6869	0.6181
Fault ac-g(c)	12616	0.9652	12619	0.9565	7050.3	0.6985	7050.3	0.6985
Fault abc-g(a)	12794	0.8885	12816	0.8821	12816	0.8821	12812	0.8728
Fault abc-g(b)	7573.6	0.5487	7562.7	0.5406	7562.7	0.5406	7575.1	0.5371
Fault abc-g(c)	12616	0.9652	12464	0.9573	1264.5	0.9573	12655	0.9543
External Faults								
Fault a-g	0.0114	6.48e-04	8.0150	0.0128	173.65	0.0818	185.93	0.0751
Fault b-g	0.0117	6.64e-04	8.3985	0.0132	173.65	0.0826	177.94	0.0727
Fault c-g	0.0117	6.07e-04	8.0201	0.0137	173.44	0.0820	183.30	0.0744
Fault ab-g(a)	5.56e-07	3.39e-06	8.5721	0.0129	78.66	0.0715	84.45	0.0616
Fault ab-g(b)	0.0091	5.99e-04	7.8961	0.0134	91.28	0.0813	98.42	0.0729
Fault ab-g(c)	0.0091	6.01e-04	8.7962	0.0144	131.71	0.0063	140.77	0.0103
SECONDARY FAULT	WITH LOAD							
	Training Data		Testing Data					
	Energy	STD	Energy	STD				
Fault a-g	1200.8	0.2777	1215.9	0.2703				
Fault b-g	1955	0.3032	1973.1	0.2969				
Fault c-g	765.1186	0.1846	768.8354	0.1750				
Fault ab-g(a)	5780.7	0.6323	5765.0	0.6223				
Fault ab-g(c)	4389.6	0.5318	4419.1	0.5245				
Fault bc-g(a)	3447.6	0.4092	4740.0	0.5519				
Fault bc-g(b)	4732.0	0.5603	934.1040	0.1800				
Fault ac-g(b)	2934.7	0.3700	2955.0	0.3621				
Fault ac-g(c)	2769.8	0.3434	2797.0	0.3310				
Fault abc-g(a)	7801.0	0.7157	7828.1	0.7096				
Fault abc-g(b)	5092.7	0.5061	5102.6	0.4923				

Step.4 Decision is made by energy vector calculated from inrush current and internal fault currents. In Fault detection process, internal fault is detected if energy vectors is greater than threshold value a tripping signal is issued; other wise, the relay restrains and goes to the next window.

TABLE II
 NUMBER OF FAULT EVENTS

S.No	Events	No of Cases	Target	Output
1	Normal/ External Fault	28	1	Restrain Trip signal
2	Inrush current	12	2	Restrain Trip signal
3	Internal Fault	72	3	Send Trip signal
	Total Cases	112		

 TABLE III
 CLASSIFICATION ACCURACY USING PNN

Events	No. of test cases	No. of cases identified	No. of Cases Misclassified	Classification rate (%)
Normal / External current	28	27	1	96.55
Inrush	12	12	0	100
Internal Fault	72	69	3	95.83
Total	112	108	4	96.4

VII. INTRODUCTION TO PNN

The PNN model is one of the supervised learning networks, and has many features distinct from those of other networks in learning processes. They are as follows:

- It is implemented based on the probabilistic model, such as Bayesian classifiers,
- A PNN is guaranteed to converge to a Bayesian classifier providing it is given enough training data.
- no need to set the initial weights of network,
- no relationship between learning processes and recalling processes,
- do not use the differences between the inference vector and the target vector to modify the weights of network.

The learning speed of the PNN model is very fast, making it suitable for fault diagnosis and signal classification problems in real-time.

Fig. 7 shows the architecture of a PNN model that is composed of the radial basis layer and the competitive layer [23]. In the signal classification application, the training examples are classified according to their distribution values of probabilistic density function (PDF), which is the basic principle of the PNN. A simple PDF is defined as follows

$$f_k(x) = \frac{1}{N_k} \sum_{j=1}^{N_k} \exp\left(-\frac{\|X - X_{kj}\|^2}{2\sigma^2}\right) \quad (8)$$

Modifying and employing Eq. (11) to the output vector H of the hidden layer in the PNN is as below

$$H_h = \exp\left(\frac{-\sum_i (X_i - W_{ih}^{xh})^2}{2\sigma^2}\right) \quad (9)$$

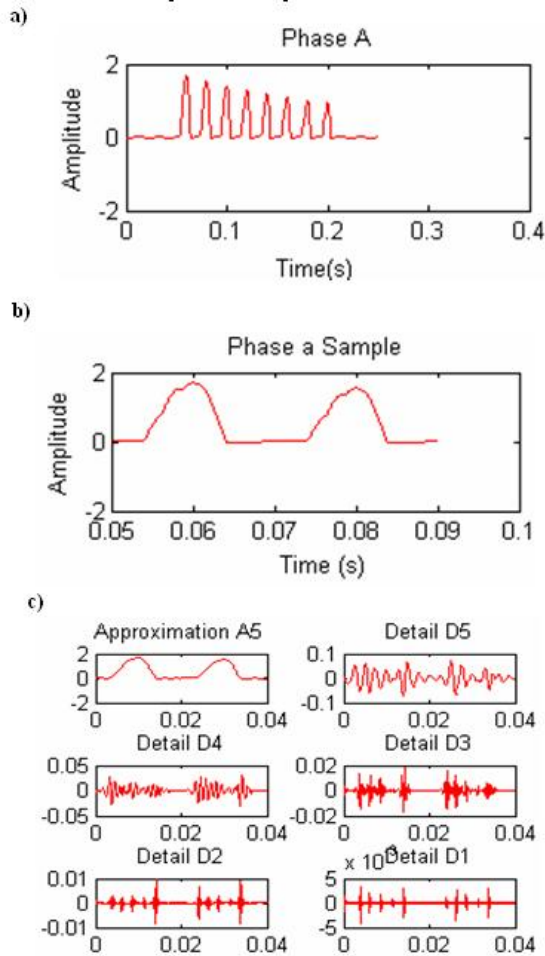

Fig. 4. Magnifying inrush current for Phase a

The algorithm of the inference output vector Y in the PNN is as follows:

$$\text{net}_j = \frac{1}{N_j} \sum_h W_{hj}^{hy} H_h \text{ and } N_j = \sum_h W_{hj}^{hy} \quad (10)$$

if $\text{net}_j = \max(\text{net } k)$ then $Y_j = 1$, else $Y_j = 0$.

Where

i is the number of input layers, h is the number of hidden layers, j is the number of output layers k is the number of training examples, N_k is the number of classifications (clusters) σ is the smoothing parameter (standard deviation), $0.1 < \sigma < 1$ In general, σ is set to 0.5. X is the input vector. $\|X - X_{kj}\|$ is the Euclidean distance between the vectors X and X_{kj} , i.e.

$$\|X - X_{kj}\| = \sum_i (X_i - X_{kj})^2 \quad (11)$$

w_{ih}^{xh} is the connection weight of between the input layer X and the hidden layer H , w_{hj}^{xh} is the connection weight of between the hidden layer H and the output layer Y . The learning and recalling processes of the PNN for classification problems can refer to [28].

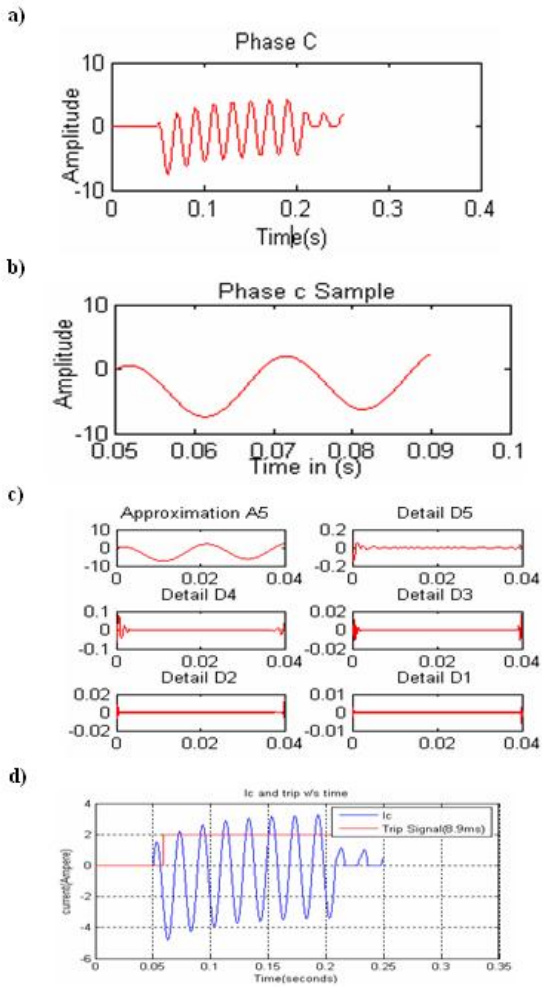

Fig. 5. Single line to ground fault for Phase c

VIII. FAULT CLASSIFICATION USING PNN

The proposed PNN model has been trained and tested using features from Tables 1. Table.2 illustrates number of events simulated are 112 cases. In that inrush current of 12 cases, internal fault current of 72 cases and external fault has been created on the transmission line for 24 events, which are simulated and measured through respective CTs. These 112 cases are processed to wavelet transform to extract features like energy and standard deviation for the above presented events and they are depicted as in the Table 1. The performances of the algorithm have also been checked by polluting the original signals with 20db noise. The extracted features from noisy signals are also shown in Tables 1. These extracted features are processed to PNN have dataset of 56 x 2 (Pair of energy and standard deviation). The target has been assigned as 1 for No fault data i.e (Normal and external fault), 2 for inrush current and 3 for fault current. During training phase, that PNN has been trained and tested with 56 dataset; and outputs of PNN are [1, 2 and 3]. The target of the PNN is built in such a way that the value 1 represents External

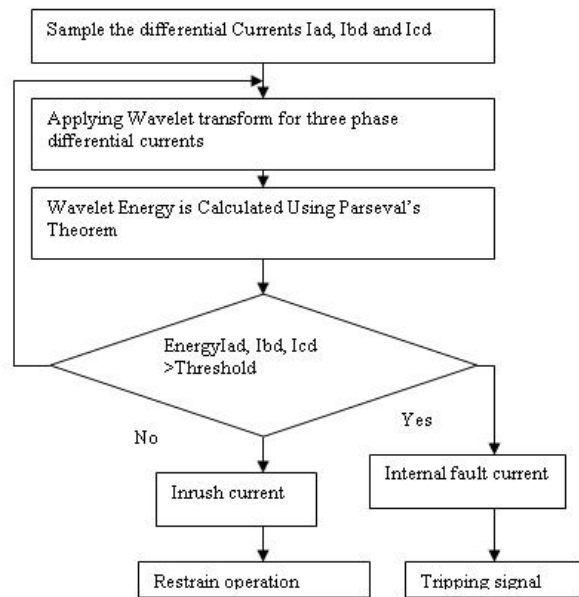

Fig. 6. Flow chart for proposed Algorithm

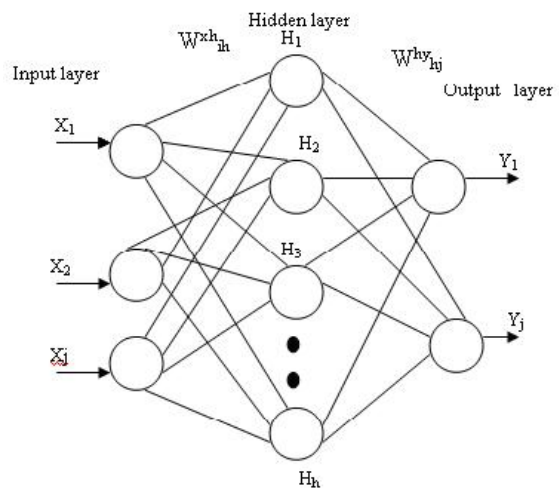

Fig. 7. PNN architecture for transformer fault

current or Normal current; the value 2 represents for inrush current, and 3 for internal fault. Table.3 illustrates that the PNN provides over all classification accuracy of 96.4.

IX. CONCLUSION

In the present work, a new algorithm for discriminating different transient phenomena is presented based on energy vector. The proposed algorithm combines advantages wavelet transform and PNN. The wavelet transform has been used for decomposition of signals, which breaks up the time domain in to low frequency and at high frequencies. Features like energy and standard deviations are extracted for different operating conditions using parsevals theorem. The signals generated using MATLAB are polluted with noise SNR 20 db to evaluate

the proposed approach. The PNN was trained with features extracted without noise in the signal but tested with signal having 20db noise. The discrimination was satisfactory even in the presence of noise.

REFERENCES

- [1] M.A. Rahman, and B.Jeyasurya, A state-of-the-art review of transformer protection algorithms, IEEE.Trans. Power Delivery, vol.3, pp.534-544, April.1988.
- [2] T.S. Sidhu, M.S. Sachdev, H.C.Wood, M.Nagpal, Design, implementation and testing of a micro-processor-based high-speed relay for detecting transformer winding faults, IEEE.Trans. Power Deliv, vol.7, pp.108-117,January 1992.
- [3] P.Bastard, M.Meunier, and H.Regal, Neural network-based algorithm for power transformer differential relays, IET Generation Trans. & Distr., vol.142, pp.386-392,1995.
- [4] P.Liu, O.P.Malik, C.Chen, G.S.Hope, and Y.Guo, Improved operation of differential protection of power transformers for internal faults,IEEE.Trans.Power Deliv., vol.7, pp.1912-1919, October 1992.
- [5] M.Geethanjali, S.M.R. Slochanal, and R.Bhavani, PSO trained ANN-based differential protection scheme for power transformers, Neurocomputing, vol.71, pp.904-918, January 2008.
- [6] D.V.Coury, and E.C. Segatto, An alternative approach using artificial neural networks for power transformer protection, European Transaction Electrical Power, vol.16, pp.63-67, October 2005.
- [7] A.Wiszniewski, and Kasztenny, A multi-criteria differential transformer relay based on fuzzy logic, IEEE.Trans.Power Deliv , vol. 10, pp. 1786-1792, October 1995.
- [8] M.C. Shin, C.W.Park, and J.H. Kim, Fuzzy logic-based relaying for large power transformer protection, IEEE.Transaction on Power Delivery, vol. 18, pp. 718-713,July 2003.
- [9] Franti sek Jan cek Martin Mucha Marian Ostrozlk, A New Protection Relay Based On Fault Transient Analysis Using wavelet Transform, Journal of Electrical Engineering, vol.58, no.3, 271278, 2007
- [10] P.L.Mao, R.K.Aggarwal, A wavelet transform based decision making logic method for discrimination between internal faults and inrush currents in power transformers, Electric Power System Research, vol. 22, pp. 389-395,June 2000.
- [11] A.R. Sedighi, and M.R. Haghifam, Detection of inrush current in distribution transformer using wavelet transform, Int. J. Power and Energy System, vol .27, pp.361-370,July 2005.
- [12] O.A.S.Youssef, A Wavelet-based technique for Discrimination between faults and Magnetizing inrush currents in transformers, IEEE Transaction on Power Delivery, vol .18, pp.170 -176, January 2003.
- [13] A.Saleh, and M.A.Rahman, Modeling and protection of a three phase power transformer using wavelet packet transform, IEEE Transaction on Power Delivery, vol.20, pp.1273-1282,April 2005.
- [14] A.Zabardast, M.R. Feyzi, and A.Mehraein, Distinction between Inrush current of Power Transformer and fault Currents in differential protection using wavelet transformer, IEEE International conference on deregulation and Restructuring and Power Technologies, Nanjing, China, p.1-6,2008.
- [15] A.I. Megahed, A.Ramadan, and W.E.L. Mahdy, Power transformer differential relay using wavelet transform energies, IEEE Power and Energy Society General Meeting, Pittsburgh, USA, pp.1-6,2008.
- [16] P.L.Mao, and R.K.Aggarwal, A novel approach to the classification of the transient phenomena in power transformers using combined wavelet transform and neural network, IEEE.Transaction on Power Delivery, vol.16, pp. 654-660,October 2001.
- [17] S.Sudha, and A.E.Jeyakmar, Wavelet and ANN based relaying for power transformer protection, Journal of computer science, vol. 3, pp. 454-460, June 2007.
- [18] S.Jazebi, B.Vahidi, S.H.Hosseinian, and J.Faiz, Magnetizing inrush current identification using wavelet based Gaussian mixture models, Simulation modelling Practice and Theory, vol. 17, pp. 991-1010, July 2009.
- [19] H.Monsef, and S.Lotffard, Internal fault current identification based on wavelet transform in power transformers, Electric Power System Research, vol. 77, pp. 1637-1645, October 2007.
- [20] Okan Ozgonenel, Wavelet based ANN approach for Transformer Protection, Int.J. Comp., Intel., vol.2, pp. 161-168,2006.
- [21] S.R.Samantaray, B.K.Panigrahi, P.K.Dash, and G.Panda, Power transformer protection using S-transform with complex window and pattern recognition approach, IET Generation Trans. & Distr, vol.1,pp. 278-286, March 2007.
- [22] Faiz,Jawad and Lotfi-Fard, A Novel Wavelet-Based Algorithm for Discrimination of Internal Faults From Magnetizing Inrush Currents in Power Transformers, IEEE Trans. Power Del.,vol.21,pp. 1989-1996,October 2006.
- [23] Zve-Lee Gaing,, Wavelet-based neural network for power disturbance recognition and classification, IEEE Transaction on Power Delivery, Vol.19, pp.1560-1568, October 2004.
- [24] S. Valsan, K. Swarup, Wavelet transform based digital protection for transmission lines, International Journal of Electrical Power & Energy Systems, Volume 31, Issue 7, ,Pages 379-388, Sep 2009
- [25] C.Sarathi, V.Sukanaya, and Y.Narasimha Murthy, ECG Signal Analysis Using Wavelet Transforms, Bulg.J. Phys, vol.35, pp-68-77, 2008
- [26] Jain-Da Wu and Chiu-Hong Liu, An automotive generator fault diagnosis system using discrete wavelet transform and artificial neural network,Expert Systems with Applications, vol. 36, pp 9776-9783, Aug 2009.
- [27] Jain-Da Wu and Chiu-Hong Liu, Investigation of engine fault diagnosis using discrete wavelet transform and neural network, Expert Systems with Applications, vol 35, pp 1200-1213, 2008
- [28] D.F.Specht, Probabilistic neural networks, Neural Networks vol.3,pp. 109-118,1990.

S.Sendilkumar graduated in Electrical Engineering from the University of Madras in 2000 and Post graduation in Energy Systems Engineering from VIT University and Pursing Ph.D from Anna university Chennai. His Current research interests are Neural Networks, Wavelet applications to Power Systems and Renewable Energy sources. He is currently associated with Electrical Engineering Department, St Peters Engineering College, Avadi.

Dr.B.L.Mathur graduated in Electrical Engineering from university of Rajasthan 1962.Post graduation in Power systems in 1964 from IIT Bombay and Ph.D from IISC Bangalore in 1979., At Present author is with SSN college of engineering as Prof and Head. His Research areas were Power system protection, machine modeling, and DSP applications in system protection, applications in power system.

Dr.Joseph Henry obtained BE in Electrical Engineering from the CIT in 1960, M.Tech in power system in 1964 from IIT Bombay and Ph.D with specialization in Electrical machines from IIT Delhi. At Present he is a Professor in Veltech University as Professor. His areas of scientific interest are Power system protection, machine modeling and digital relays