

# Intelligent ABS Fuzzy Controller for Diverse Road Surfaces

Roozbeh Keshmiri, and Alireza Mohamad Shahri

**Abstract**—Fuzzy controllers are potential candidates for the control of nonlinear, time variant and also complicated systems. Anti lock brake system (ABS) which is a nonlinear system, may not be easily controlled by classical control methods. An intelligent Fuzzy control method is very useful for this kind of nonlinear system. A typical antilock brake system (ABS) by sensing the wheel lockup, releases the brakes for a short period of time, and then reapplies again the brakes when the wheel spins up. In this paper, an intelligent fuzzy ABS controller is designed to adjust slipping performance for variety of roads. There are two major sections in the proposing control system. First section consists of two Fuzzy-Logic Controllers (FLC) providing optimal brake torque for both front and rear wheels. Second section which is also a FLC provides required amount of slip and torque references properties for different kind of roads. Simulation results of our proposed intelligent ABS for three different kinds of road show more reliable and better performance in compare with two other break systems.

**Keywords**—Fuzzy Logic Control, ABS, Anti lock Braking System.

## I. INTRODUCTION

THE main disadvantage of the ordinary brakes is that the driver can not precisely control the brake torque applied to the wheels. Moreover, as the driver does not have enough information of the road conditions, he may cause locking up the wheels by applying extra pressure on the brake pedal. The wheel lock up not only ends to have maximum stopping distance, but also causes lateral instability of the vehicle. All modern vehicles are equipped with anti lock braking system that prevents locking of wheels. Anti lock brake decreases the stopping distance of vehicle and improves controllability of vehicle in compare with other brake systems lacking ABS.

When a vehicle accelerates or brakes, the tractive forces  $F_{ff}$  and  $F_{fr}$  developed by the front and rear tire, respectively are proportional to the normal forces of the road acting on the tire ( $F_{zf}$  and  $F_{zr}$ ) as illustrated in Fig. 1. The coefficient of proportionality, denoted by  $\mu$ , is called the road coefficient of adhesion and it varies depending on the road surface type, as shown in Fig. 2. The *wheel slip*, denoted by  $\lambda$ , is the ratio of

the difference between the velocity of the vehicle and the translational velocity of the wheel to the velocity of the vehicle [1].

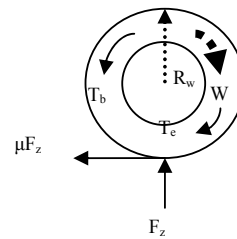

Fig. 1 Front wheel free-body diagram [9]

The goal of the Anti-lock brake system is to hold each tire of the vehicle operating near the peak of the  $\mu - \lambda$  curve for that tire, which implies performance of an ABS is strongly related to the surface condition. Up to now different control methods have been developed to keep wheels slip in desired interval. Anti lock brake systems based on Sliding Mode Control [2], Neural Network [3], and Fuzzy Logic Controller [4-7] are a few examples of the ABS design. As shown in Fig. 2, it can not be expected that an anti-lock brake system which is optimized for dry asphalt, performs as reliable as on a wet or icy surfaces.

However, an intelligent method based on identifying the type of surface, which is proposed in this paper, may adapt itself for different condition of road surfaces to have optimized wheel slip. The Main propos of this control method is to identify road surface condition which leads to an optimized brake efficiency for different surface conditions.

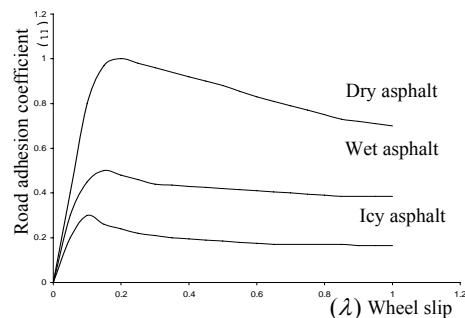

Fig. 2  $\mu$ - $\lambda$  curves for different road conditions

Manuscript received June 30, 2007. Roozbeh Keshmiri is with the member of Young Researchers Club, Tabriz Islamic Azad University, and member of IAUT-CRL (computer Research Laboratory), Tabriz, Iran (phone: +98 914 411 1418; e-mail: roozbeh.keshmiri@gmail.com).

Ali M. Shahri is with the Electronic Research Center, Iran University of Science and Technology, Narmak, Tehran, 16844, Iran (phone: +98 21 73913704; fax: +98 21 77893174; e-mail: shahri@iust.ac.ir).

Fuzzy control system presented in this paper is consisted of three sections which are shown as FLC1, FLC2 and FLC3. All Fuzzy controllers are designed and simulated by MATLAB™ software. The FLC1 and FLC2 which are designed for front and rear wheels are exactly similar and have similar Fuzzy-Logic-Components. In these two FLCs the optimal brake torque for front and rear sections are considered as FLC output. The FLC3 determines the amount of optimal wheel slip based on the vehicle acceleration.

## II. VEHICLE BRAKE SYSTEM MODEL

The development of FLC for vehicle brake system which is discussed in this part is generally based on the work carried out by Will and Zak [9]. A straight-line braking with no steering is assumed in this work. We have also neglected the effects of pitch and roll for simplicity.

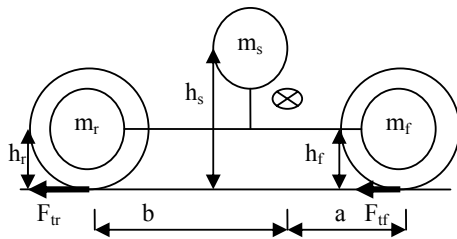

Fig. 3 Vehicle free-body diagram

A vehicle-free body diagram for the straight-line braking maneuver is shown in Fig. 3. The symbols, parameters and values which are used in our simulation are described in Table I.

TABLE I VEHICLE BRAKE SYSTEM DATA		
$g$	acceleration due to gravity	9.81m/s <sup>2</sup>
$a$	distance from center of gravity to front axle	1.186m
$b$	distance from center of gravity to rear axle	1.258m
$h_s$	height of the sprung mass	0.6 m
$h_f$	height of front unsprung mass	0.3 m
$m$	height of rear unsprung mass	0.3 m
$m_{tot}$	total mass of the vehicle	1500 kg
$m_s$	sprung mass of the vehicle	1285 kg
$m_f$	front unsprung mass	96 kg
$m_r$	rear unsprung mass	119 kg
$J_f$	moment of inertia of the front wheel	1.7 gm <sup>2</sup>
$J_r$	moment of inertia of the rear wheel	1.7 kgm <sup>2</sup>
$R_w$	radius of tire	0.326 m
$T_e$	engine torque	0 Nm
$K_{br}$	brake displacement proportionality constant	0.5

The front and rear tractive forces are denoted  $F_{tf}$  and  $F_{tr}$  respectively. The total tractive force, denoted  $F_{tot}$ , is;

$$F_{tot} = F_{tf} + F_{tr}$$

$$F_{tf} = \mu(\lambda_f)F_{zf}, F_{tr} = \mu(\lambda_r)F_{zr}$$

Where

$F_{zf}$  and  $F_{zr}$  are normal forces acting on the front and rear tires, respectively, and

$\mu(\lambda)$  is the road coefficient of adhesion which is a function of the wheel slip  $\lambda$ . For the front tire,  $\lambda = \lambda_f$  while for the rear tire  $\lambda = \lambda_r$ . The wheel slip is defined as;

$$\lambda = \frac{V - wR_w}{V} = 1 - \frac{wR_w}{V}$$

Where  $V$  is the vehicle velocity,  $w$  is the angular velocity of the tire, and  $R_w$  is the radius of the tire. It should be noted that  $0 \leq \lambda \leq 1$  and it is common to present the values of  $\lambda$  in percent.

Wheel lockup occurs when  $\lambda = 100\%$  or ( $\lambda = 1$ ) which equivalently, means the angular velocity of wheel is  $w = 0$ . However, as can be seen in Fig. 2, a wheel lockup does not have the maximum coefficient of adhesion, and thus, does not lead to the maximal braking force. The maximum braking force is achieved when the wheels are slipping. For example, in Fig. 2, for an icy road, the maximal braking force is achieved when the wheel slip is about 1. It also should be noted that tractive force is a functions of normal force and there are two components in the normal force. One component is due to the mass distribution of the vehicle, while the other component comes from the mass transfer of the vehicle. Based on the vehicle dynamics equations and performing some manipulations, we obtain;

$$\ddot{x} = -g \frac{\mu(\lambda_f)m_1 + \mu(\lambda_r)m_3}{m_{tot} - \mu(\lambda_f)m_3 + \mu(\lambda_r)m_3} \quad (1)$$

Where

$$m_1 = bm_{tot} / (a + b),$$

$$m_2 = am_{tot} / (a + b),$$

$$m_3 = (m_f h_f + m_s h_s + m_r h_r) / (a + b)$$

The state variables could be defined as;

$$x_1 = x, x_2 = \dot{x}, x_3 = w_f, x_4 = w_r$$

Therefore, the vehicle brake state space model and its output could be presented as follow,

$$\begin{cases} \dot{x}_1 = x_2 \\ \dot{x}_2 = \dot{f}_2 = -g \frac{\mu(\lambda_f)m_1 + \mu(\lambda_r)m_2}{m_{tot} + m_3(\mu(\lambda_r) - \mu(\lambda_f))} \\ \dot{x}_3 = \dot{f}_3 = \frac{1}{2J_f} (-T_{bf} + \mu(\lambda_f)m_1 R_w g - \mu(\lambda_f)m_3 R_w \dot{x}_2 + T_e) \\ \dot{x}_4 = \dot{f}_4 = \frac{1}{2J_f} (-T_{br} + \mu(\lambda_r)m_2 R_w g + \mu(\lambda_r)m_3 R_w \dot{x}_2) \end{cases} \quad (2)$$

$$y = [x_1, x_2, \lambda_f, \lambda_r]^T \quad (3)$$

Note that our brake system model is composed of only four, nonlinear, differential equations, which makes it suitable for our design purposes. Ref. [10] could be referred for more details of the derivations of the vehicle brake system model.

III. DESIGNING FUZZY CONTROLLER

The Fuzzy controllers which are designed in this paper, are shown in Fig. 4. As it is explained it has three sections FLC1, FLC2 and FLC3. In FLC1 and FLC2, optimal brake torques for front and rear wheels are determined based on given inputs which are 1) error of slip ratios and 2) error of optimal torque with torque of wheels. FLC3 also determines optimal slip and torque according to the vehicle acceleration as its input. First input for FLC1 and FLC2 is error of slip ratios, i.e. It is difference between wheel slip and reference slip.

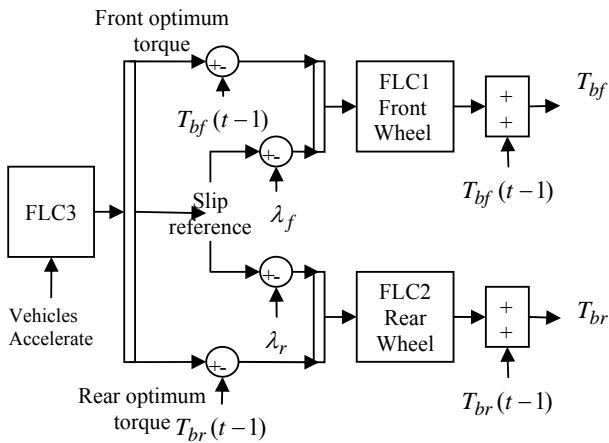

Fig. 4 Schematic of the proposed fuzzy ABS controller

Reference slip is amount of optimal slips for all road surfaces which is outcome of the second output of FLC3. This error for front and rear wheels is;

$$e_f(t) = \lambda_{ref} - \lambda_f(t)$$

$$e_r(t) = \lambda_{ref} - \lambda_r(t)$$

This input has 5 linguistic values as shown Figure 5.

error = [vneg, neg, zero, pos, vpos]

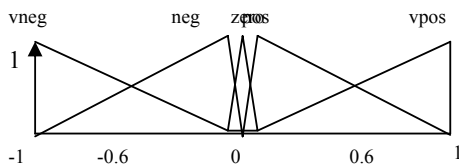

Fig. 5 Membership functions for first input of FLC1&FLC2

Second input of FLC1 & FLC2 is error of brake torque or  $T_b$ , that is difference between the last applied brake torque and optimal torque. The amount of required torque reference

is the optimal torque of each surface that results from the first and third outputs of FLC3. This error for front and rear wheels is;

$$e_{Tbf} = T_{bfref} - T_{bf}(t-1)$$

$$e_{Tbr} = T_{brref} - T_{br}(t-1)$$

This input is fuzzified by five linguistic values which are defined below in the universe of discourse [5000 -5000].

Error = [vfew, few, zero, big, vbig]

Fig. 6 shows membership function of second input for FLC1 and FLC2.

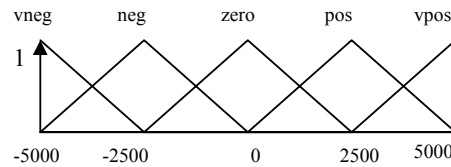

Fig. 6 Membership function for second input of FLC1&FLC2

Out put of these two Fuzzy controllers is the variation of torques  $\Delta T_b$  which adds up to the previous applied torques to generate required braking torque for each wheels.

$$T_b(t) = T_b(t-1) + \Delta T_b$$

Where  $T_b$  refers to brake torques. Membership function of  $\Delta T_b$  which are defined by five linguistics values as below are shown in Fig. 7.

$\Delta T_b = [vneg, neg, zero, pos, vpos]$

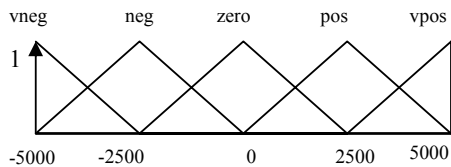

Fig. 7 Membership functions for output of FLC1 & FLC2

There are 9 “IF-THEN” Fuzzy Rules for each of FLC1 and FLC2. A 3-D input-output map for FLC1&FLC2 is illustrated in Fig. 8.

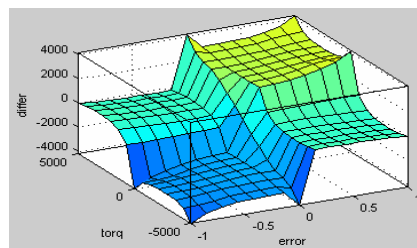

Fig. 8 3-D input-output map for FLC1 & FLC2

FLC3 which is shown in Fig. 4 is applied to determine slip and torque references for different road surfaces. According to Fig. 2 which shows slip and adhesions  $\mu$ - $\lambda$  curves for different road conditions, it is obvious that there is no constant slip

values for maximum road adhesion in different road surfaces such as; dry, wet or icy asphalts. Therefore, it is possible to define optimum slip reference for FLC1 & FLC2 by FLC3 which consequently results in maximum adhesion applied to the brake system. Input of the FLC3 is vehicle acceleration which is shown in Fig. 9 by 5 linguistic membership functions as below;

Accelerate = [vbig, big, med., small, vsmall]

In this fuzzy controller, we may identify the type of road surface by vehicle acceleration.

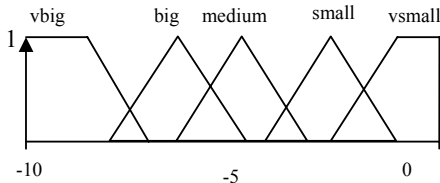

Fig. 9 Membership function for input of FLC3

There are three optimum outputs for FLC3, front brake torque, slip and rear brake torque. All three output membership functions in FLC3 are defined with 5 similar linguistics values as below;

Reference = [Icy, Icy-wet, wet, wet-dry, dry]

Fig. 10 illustrates output membership functions for optimal front and rear wheel brake torque which could be adjusted based on slip and road adhesion relationship.

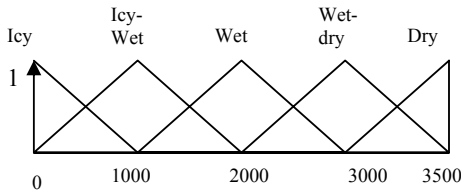

Fig. 10 Membership function for first & third outputs of FLC3

Fig. 11 also illustrates output membership function for optimal slip.

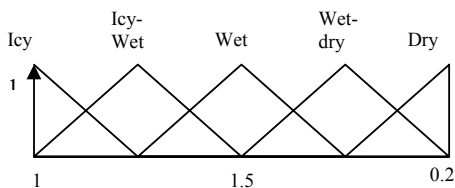

Fig. 11 Membership function for second outputs of FLC3

#### IV. SIMULATION RESULTS

In order to simulate the proposed intelligent fuzzy controller and compare the simulation results with other methods, it is assumed that the vehicle is moving at 20 m/s, (72 km/h). It should be noted that all the simulation results are based on the assumption of straight-line braking in the brake system model and neglect of transportation delay caused by the brake

hydraulic systems and brake pad travel as in [6], [8]. Simulation results are compared based on braking or stopping distance, vehicle speed profile and also wheel slip for three different states of a vehicle a) without ABS, b) ABS with constant slip and finally c) with proposed ABS. In the process of simulation, three different surfaces are applied to vehicle braking systems in series, i.e. a simulation surface starting with 10 meters of dry asphalt, and then 20 meters of wet asphalt and finally change to an icy condition. As it is shown in Figs. 12 and 13 for a vehicle without ABS, stopping distances is approximately 80 meters and stopping time is 10 seconds. As in this case, there is no ABS system wheel slip for front and rear wheels will be one and wheels will be locked up which it consequently results in larger stopping distance (Fig. 14).

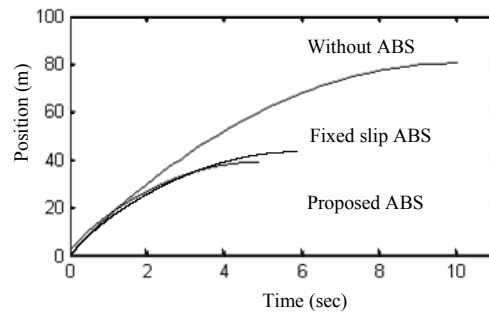

Fig. 12 Plots of the vehicle position on the surface changing from dry asphalt to wet asphalt after 10m and icy asphalt after 20m for three different of braking systems

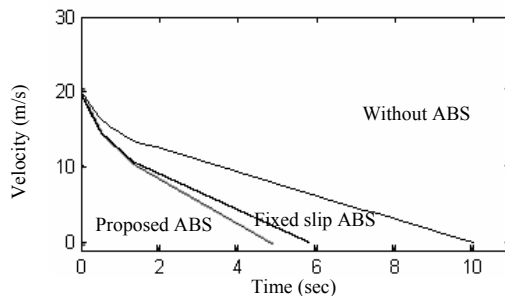

Fig. 13 Plots of the vehicle velocity on the surface changing from dry asphalt to wet asphalt after 10m and icy asphalt after 20m for different of braking maneuvers

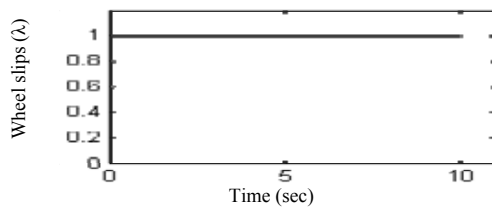

Fig. 14 Plots of wheel slip on brake without ABS

As the second braking method, ABS with constant slip (0.2 for all three different surfaces) is applied. As it is shown in Figs. 12 and 13, stopping distance has been reduced to approximately 43 meters and stopping time is about 6 seconds.

Figs. 15 and 16 illustrate the wheel slips for front and rear wheels.

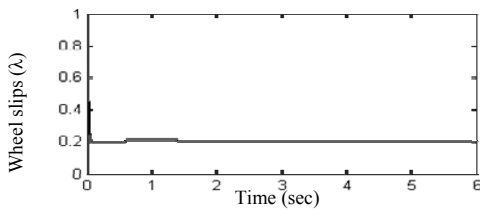

Fig. 15 Plot of front wheel slip on brake with fixed slip ABS

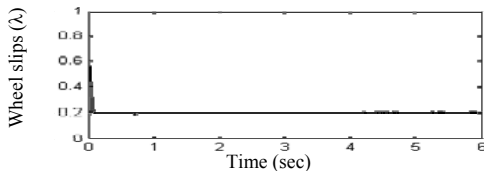

Fig. 16 Plot of rear wheel slip on brake with fixed slip ABS.

Finally, the proposed ABS is applied to the simulation process and according to the Figs. 12 and 13 there is an evident superior performance in simulation results in compare to other two methods. Stopping distance has been reduced to 40m and stopping time has been reduced to 5 seconds. Figs. 17 and 18 also illustrate adaptive wheel slip based on the changing surface conditions. This result verifies that the proposed fuzzy controller (FLC3) is able to generate different wheel slip according to the surface condition.

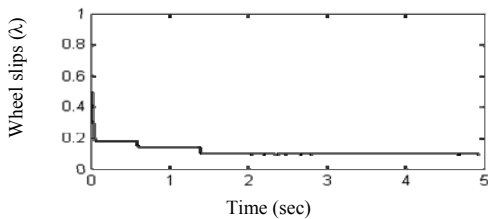

Fig. 17 Plot of front wheel slip in proposed ABS

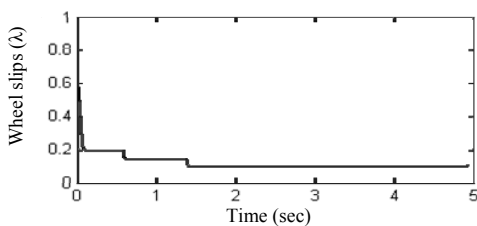

Fig. 18 Plot of rear wheel slip in proposed ABS.

Applied brake torque to the front and rear wheels by the proposed ABS control system have been shown in Figs. 19, 20.

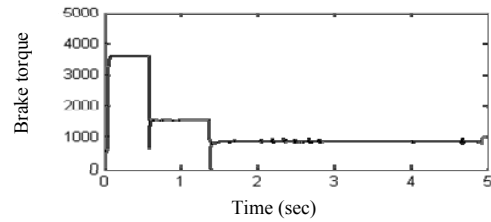

Fig. 19 Front wheel applied brake torque by the proposed ABS

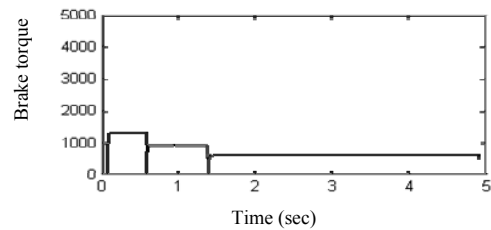

Fig. 20 Rear wheel applied brake torque by the proposed ABS

Acceleration of Vehicle for different surfaces which is an input of the FLC3 is also shown in Fig. 21. This acceleration is actually the reason to determine adaptive slip wheel based on the surface condition.

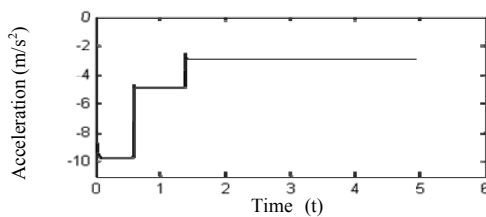

Fig. 21 Plot of vehicle acceleration in proposed ABS.

### V. CONCLUSION

In this paper an intelligent ABS fuzzy controller is designed. The vehicle dynamic based on the half of vehicle equations are presented in the form of state space model. This model is applied for all simulation process using MATLAB SIMULINK toolbox. Simulation results verify the superior performance and quality of the proposed Intelligent ABS fuzzy controller over other methods without identifying road conditions. This controller has excellent ability to apply continuous brake torque and accordingly determines optimal slip to reduce stopping interval and distance. Two parallel fuzzy controllers have been designed to determine braking torque for front and rear wheels respectively. Furthermore, third fuzzy controller is designed to determine optimal slip and torque for different road surfaces.

### REFERENCES

[1] J. Y. Wong, Theory of Ground Vehicles. New York: J. Wiley & Sons, second ed., 1993.

- [2] S. Drakunov, Ü. Özgüner, P. Dix, and B. Ashrafi, "ABS control using optimum search via sliding modes," IEEE Trans. Contr. Syst. Technol., vol. 3, pp. 79–85, Mar. 1995.
- [3] L. I. Davis, Jr., G. V. Puskorius, F. Yuan, and L. A. Feldkamp. "Neural Network Modeling and Control of an Anti-Lock Brake System" Research Laboratory, Ford Motor Company, IEEE, 1993.
- [4] A. Mirzaei, M. Moallem, B. Mirzaeian, B. Fahimi, "Design of an Optimal Fuzzy Controller for Antilock Braking Systems" IEEE, 2005.
- [5] J. R. Layne, K. M. Passino, and S. Yurkovich, "Fuzzy learning control for antiskid braking systems," IEEE Trans. Contr. Syst. Technol., vol. 1, pp. 122–129, June 1993.
- [6] G. F. Mauer, "A fuzzy logic controller for an ABS braking system," IEEE Trans. Fuzzy Syst., vol. 3, pp. 381–388, Nov. 1995.
- [7] W. K. Lennon and K. M. Passino, "Intelligent control for brake systems," IEEE Trans. Contr. Syst. Technol., vol. 7, pp. 188–202, March 1999.
- [8] B. Friedland, Advanced Control System Design. Englewood Cliffs, NJ: Prentice-Hall, 1996.
- [9] A. B. Will and S. H. Zak, "Antilock brake system modeling and fuzzy control," Int. J. of Vehicle Design, vol. 24, no. 1, pp. 1-18, 2000.
- [10] Y. Lee and S.H.Zak, "Designing a genetic neural fuzzy anti-lock brake system controller," IEEE Trans. on Evolutionary Computation, vol. 6, no. 2, pp. April 2002 in press.