

T-DOF PI Controller Design for a Speed Control of Induction Motor

Tianchai Suksri, and Satean Tunyasirirut

Abstract—This paper presents design and implements the T-DOF PI controller design for a speed control of induction motor. The voltage source inverter type space vector pulse width modulation technique is used the drive system. This scheme leads to be able to adjust the speed of the motor by control the frequency and amplitude of the input voltage. The ratio of input stator voltage to frequency should be kept constant. The T-DOF PI controller design by root locus technique is also introduced to the system for regulates and tracking speed response. The experimental results in testing the 120 watt induction motor from no-load condition to rated condition show the effectiveness of the proposed control scheme.

Keywords—PI controller, root locus technique, space vector pulse width modulation, induction motor.

I. INTRODUCTION

ADJUSTABLE speed ac drives, mostly based on induction motors, constitute the most common application of inverters for indirect ac-to-dc power conversion. Various types of ac motor drives have been developed over the years, for the purpose of control of speed, torque, and position. Depending on the quality of control, the drive system can be classified as low-or high-performance. The space vector modulation (SVM) technique is an advanced, computation intensive PWM method and possibly the best among all the PWM techniques for variable frequency drive application. Because of its superior performance characteristics, it has been finding widespread application in recent year. The PWM methods discussed so far have only considered implementation on half bridges operated independently, giving satisfactory PWM performance. With a machine load, the load neutral is normally isolated, which causes interaction among the phases. This interaction was not considered before in the PWM discussion. SVM method considers this interaction of the phase and optimizes the harmonic content of the three phase isolated neutral load. [1-3].

Manuscript received October 15, 2007. The research has been supported in part by Faculty of Engineering, Pathumwan Institute of Technology, Bangkok 10330, Thailand.

Tianchai Suksri is with Lecturer at Department of Instrumentation Engineering, Faculty of Engineering, Pathumwan Institute of Technology, Bangkok 10330, Thailand. His research interests include Control Engineering.

Satean Tunyasirirut is with Asst. Prof. Dr. at Department of Instrumentation Engineering, Pathumwan Institute of Technology, Thailand. His research interests include modern control, intelligent control, Power Electronics, Electrical Machine and Drives (e-mail:satean2000@gmail.com).

To design controller by root locus technique [4], adjustment of speed response and the damping ratio can be done by assign settling time and percent overshoot respectively. Therefore, this technique is convenient and suitable for design controller under the requirement of the system.

In this paper presents the design of the T-DOF PI controller by root locus technique [4] for speed control of induction motor using space vector pulse width modulation technique.

II. MODEL OF INDUCTION MOTOR FOR SPEED CONTROL

In drive operation, the speed ω_r can be controlled indirectly by controlling the torque which, for the normal operating region, is directly proportional to the voltage to frequency. The torque T_e [5] given by equation also

$$T_e = 3 \left(\frac{P}{2} \right) \left(\frac{V_s}{\omega_e} \right)^2 \frac{\omega_{slm} R_r}{R_r^2 + \omega_{slm}^2 L_{lr}^2} \quad (1)$$

by
 T_e is developed torque ($N \cdot m$)
 P is pole of induction motor
 ω_e is stator supply frequency (rad/s)
 $\omega_{slm} \cdot L_{lr}$ is leakage reactance (Ω)
 R_r is rotor resistance (Ω)
 V_s is input voltage per phase ($Volt$)

The machine torque and speed are related by the following equation

$$J \frac{d\omega_r}{dt} + B\omega_r = T_e - T_L \quad (2)$$

by
 J is moment of inertia
 B is viscous friction
 T_L is load torque ($N \cdot m$)

From relationship among equation (1) and (2), transfer function of induction motor for speed control is

$$\frac{\omega_r}{V_s} = \frac{K}{J_s + B} \quad (3)$$

by K is $3 \left(\frac{P}{2} \right) \left(\frac{1}{\omega_e} \right)^2 \frac{\omega_{slm} R_r}{R_r^2 + \omega_{slm}^2 L_{lr}^2}$

III. STRUCTURE OF THE CONTROL SYSTEM

The control system structure consists of 2 parts as shown in Fig. 1. The first part is the induction motor and the second part is two degree of freedom controller.

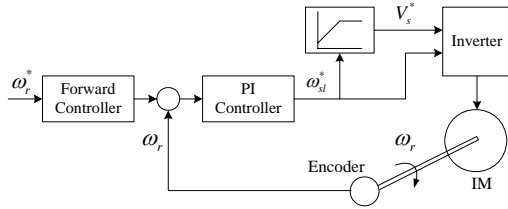

Fig. 1 The control system structure

For the part of two degree of freedom controller is consists of feedback controller and forward pre-filter controller. The two degree of freedom is design using root locus technique [4]. The equations of feedback controller and forward controller are shown in equation (4) and (5) respectively

$$G_c = \frac{(s + z_c)}{s} = \frac{K_p s + K_i}{s} \quad (4)$$

$$G_f = \frac{z_c}{(s + z_c)} \quad (5)$$

IV. THE ROOT LOCUS TECHNIQUE

To design the controller must be defined the characteristic of transient response and steady state response that can be explained as. [4]

- 1) The characteristic of transient response can be described in form of percent overshoot (P.O.)
- 2) The characteristic of steady state response can be described in form of settling time t_s

The method to design for satisfying response at the transient state and steady state can be applied as following steps.

Step 1. Finding the damping ratio: ζ and under damped natural frequency: ω_n by considering the characteristic of transient response and steady state response from the equation (6).

$$P.O. = 100 * e^{\zeta\pi / \sqrt{1-\zeta^2}} \%, \quad t_s^{(\pm 2\%)} = 4 / \zeta\omega_n \quad (6)$$

$$s_d = -\zeta\omega_n \pm j\omega_n\sqrt{1-\zeta^2}$$

Step 2. Finding the summation of angle at s_d of the open loop system $G_c(s)G_p(s)$ by graphical method or arithmetical method and then consider the essential angle of $\angle(s_d + z_c)$ in order to the summation of angle will be being according to the system condition.(7).

$$\sum(\theta_z + \theta_{z_c}) + \sum\theta_p = -(2k+1)\pi, \quad k = 0, 1, \dots, n \quad (7)$$

Step 3. Finding the gain K_c of the controller by using the root locus technique.

$$K_c = K_{sd} = \frac{1}{|G(s_d)H(s_d)|} \quad (8)$$

Step 4. Substitution all of the parameters in the equation of controller.

Step 5. Plot the root locus of $G_c(s)G_p(s)$ in order to confirm that the root locus passes the defined point s_d .

Step 6. To obtain the satisfying response by inputting step signal therefore, adding the feed forward controller as shown in equation (9).

$$G_f(s) = \frac{z_c}{(s + z_c)} \quad (9)$$

V. EXPERIMENT RESULTS

A. Experiment Setup

The experimental setup mainly consists of a dSPACE DS1104 DSP [6-7] controller board, a Pentium IV 1.5 GHz PC with Windows XP, a three phase induction motor which has the detail as follows: 120 watt, 220/380V, 0.78/0.45 A, 50Hz, P.F 0.79 lag and 2600 rpm. A 30 pulse/rev incremental encoder for speed measurement is used. The DS1104 board is installed in Pentium IV PC. The control program is written in SIMULINK environment combined with the real-time interface of the DS1104 board. The main ingredient of the software used in the laboratory experiment is based on MATLAB/Simulink programs. The control law is designed in simulink and executed in real time using the dSPACE DS1104 DSP board. Once the controller has been built in simulink block-set, machine codes are achieved that runs on the DS1104 TMS320F240 DSP processor. While the experimental is running, the dSPACE DS1104 provides a mechanism that allows the user to change controller parameter online. Thus, it is possible for the user to view the real process while the experiment is in progress. A dSPACE Connector panel (CP1104) provides easy access to all input and output signals of the DS1104 board. All current and voltage are measured using LEM sensors, and both of them are then transformed to be a voltage ranging from 0 to ± 10 volts which will be the input of A/D respectively. This scheme enables the user to adjust the speed of motor by the duty cycle of the V/F operating in SVM mode.[8-11]

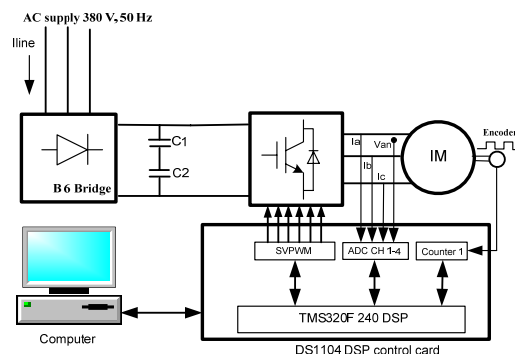

Fig. 2 Experimental Setup

B. Design and Simulation of Control System

In this topic, The PI controller design by using root locus technique will be explained. The process model which achieved by experiment the equation (7) is employed to design the controller under this condition.

$$P.O. \leq 5\%, t_s^{(\pm 2\%)} \leq 3\text{sec}, e_{ss}(t) = 0$$

From the conditional requirement, it is to be:

$$\zeta = 0.6901, \omega_n = 0.0193, s_d = -0.0133 \pm j0.14.$$

And then it is obtained:

$$\theta_c = 81.0484, z_{c1} = 0.0155, z_{c2} = 0.0885, K_c = 18.2115.$$

Therefore, the feedback controller and feed forward controller are able to be shown as following:

$$G_c = \frac{18.2115s^2 + 1.8948s + 0.025}{s} \quad G_f = \frac{0.0155}{s + 0.0155}.$$

C. Step Response of Speed

To evaluate the performance of the system, a series of measurements has been accomplished. The measurements can be divided in two groups: the first is a step change of the speed reference at constant load torque and the second is a step change of the load torque at constant speed reference. Figs. 3~6. as shown performance of controller. To be tested time response of speed via the step change of speed reference 600 to 1200 rpm, 1200 to 2400 rpm with the load torque equal to zero and equal to rated respectively.

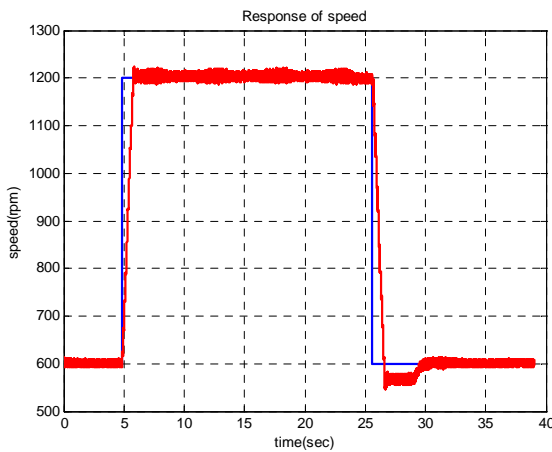

Fig. 3 Step change of speed reference 600-1200 rpm at zero load

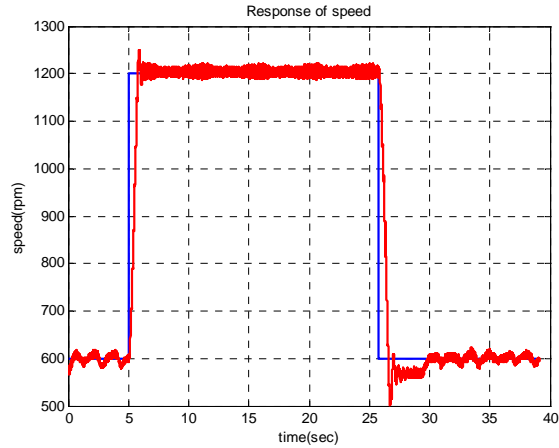

Fig. 4 Step change of speed reference 600-1200 rpm at rated load

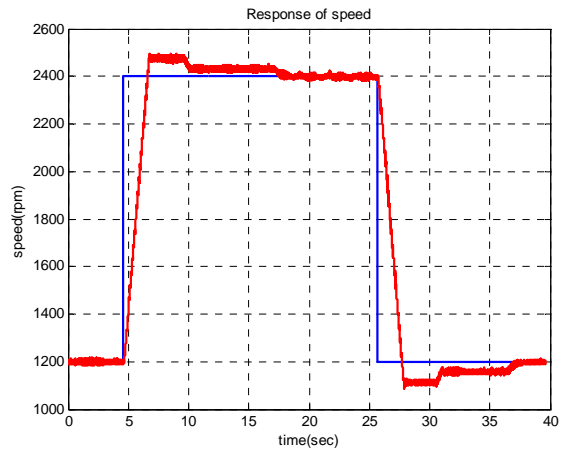

Fig. 5 Step change of speed reference 1200-2400 rpm at zero load

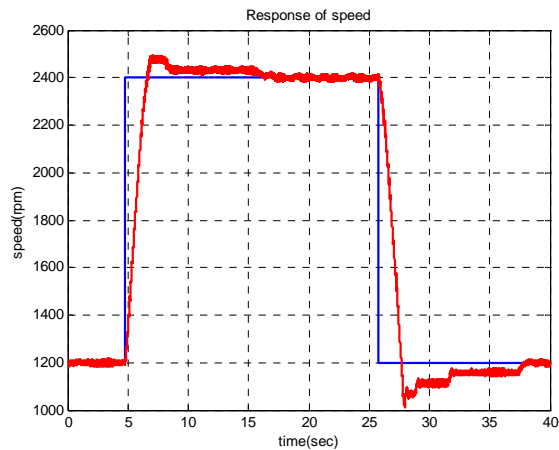

Fig. 6 Step change of speed reference 1200-2400 rpm at rated load

Figs. 7~8. as shown time response of speed via the step change of the load torque at constant speed reference 1200 and 2400 rpm respectively. Figs. 9~10. as shown steady state waveforms of speed at reference speed 1200 and 2400 rpm rated load respectively. It's found that it have state error less than ± 10 rpm. From the results tested the performance of controller by a step change of the speed reference as shown in Figs. 3~6, it's found that the Rise time(t_r)=2.0 second, Peak time(t_p) = 3 second, Settling time(t_s)=10 second, Maximum overshoot(M_p) = 25 % at zero load and a step change of the load torque at constant speed reference as shown in Figs. 9~10, it's found that the Settling time(t_s) = 5 second. From the experimental results obtained, the proposed PI controller can keep the motor speed to be constant at the speed ranging from 600 to 2400 rpm.

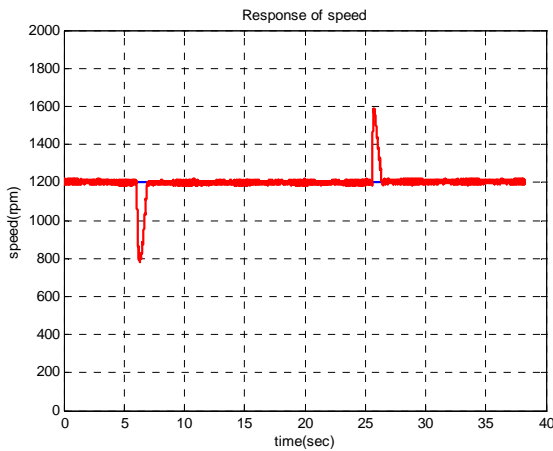

Fig. 7 Step change of load torque at constant speed reference 1200 rpm

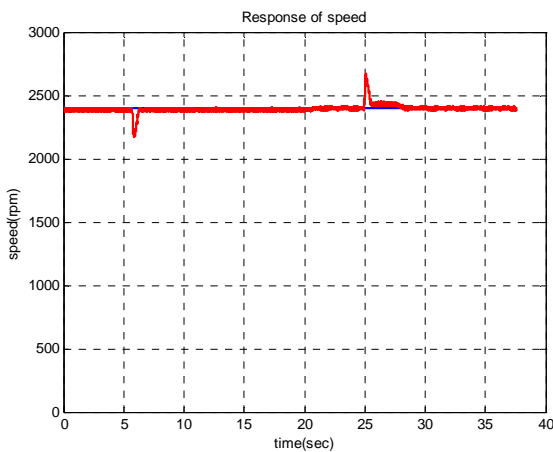

Fig. 8 Step change of load torque at constant speed reference 2400 rpm

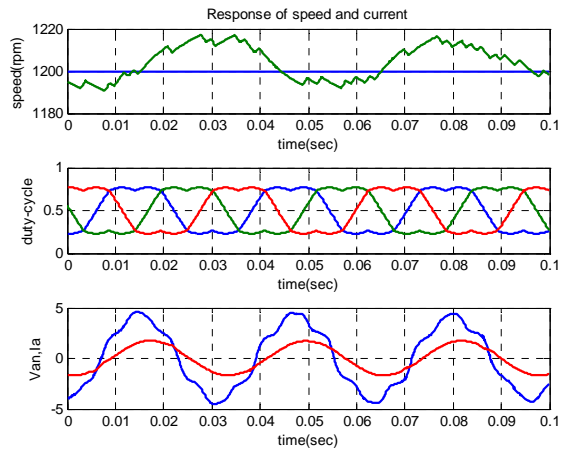

Fig. 9 Steady state waveforms for speed reference 1200 rpm at rated load

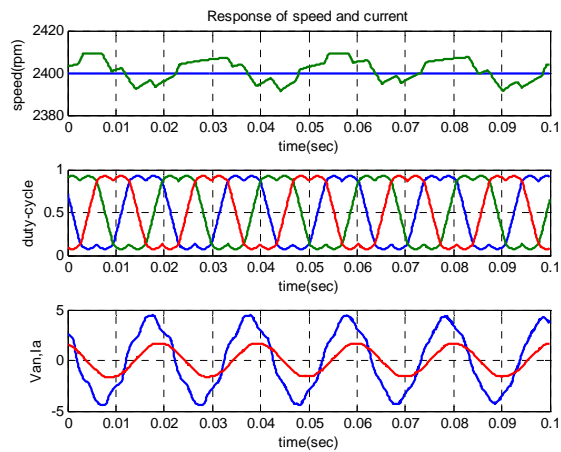

Fig. 10 Steady state waveforms for speed reference 2400 rpm at rated load

VI. CONCLUSION

The experimental results are analyzed in testing the 120 watt induction motor from no-load condition to rated condition; it's found that the speed of the induction motor can be controlled at the desired speed without steady-state error. In addition, the motor speed to be constant when the load varies.

ACKNOWLEDGMENT

The authors gratefully thank the financial support from Faculty of Engineering, Pathumwan Institute of Technology, Bangkok 10330.

REFERENCES

[1] Andrzej M. Trzynadlowski, *Introduction to Modern Power Electronics*, John Wiley & Sons, 1998.
 [2] Bimal K.Bose, *Modern Power Electronics and AC Drives*, © Prentice Hall PTR, 2002.

- [3] W. Leonhard, *Control of Electrical Drives*, Springer-Verlag Berlin Heidelberg, New York, Tokyo, 1985.
- [4] Numsomran A., "2-DOF Control System Designed by Root Locus Technique", in *Proc. 15th KACC control*, Korea, October 2000
- [5] Bimal K. Bose, *Modern Power Electronics and AC Drives*, Prenti Hall PTR, 2002
- [6] *DSP Based Electric Drives Laboratory User Manual : Frequency Control of AC-Motor Drives.*, Department of Electrical and Computer Engineering University of Minnesota.
- [7] *Introduction Getting Started with dSPACE DSP Based Laboratory of Electric Drives.*, Department of Electrical and Computer Engineering University of Minnesota.
- [8] Tunyasrirut S., "Implementation of a dSPACE based Digital State Feedback Controller for a Speed Control of Wound Rotor Induction Motor", in *Conf. 2005 IEEE Int. Conf. Industrial Technology*, 14-17 Dec.2005, pp. 1198-1203.
- [9] Satean Tunyasrirut, Sompong Srilad and Tianchai Suksri, "Fuzzy Logic Control for a Speed Control of Induction Motor using Space Vector Pulse Width Modulation", *Transaction on Engineering, Computing and Technology Volume 19 January 2007 ISSN 1305-5313*, pp 71-77.
- [10] Satean Tunyasrirut and Sompong Srilad "Speed Control with Slip Regulation of Induction Motor Drives with Space Vector Pulse Width Modulation Technique", *Proceeding of the Third IASTED Asian Conference Power and Energy Systems" April 2-4, 2007, Phuket, Thailand, ISBN CD: 978-0-88986-657-7*, pp 12-16.
- [11] Sompong Srilad, Satean Tunyasrirut and Tianchai Suksri, "Implementation of a Scalar Controlled Induction Motor Drives" *SICE-ICASE International Joint Conference 2006, Oct. 18-21, 2006 in Bexco, Busan, Korea*, pp 3605-3610.



Tianchai Suksri received in B.Eng. and M.Eng in Instrumentation Engineering from King Mongkut's Institute of Technology Ladkrabang (KMITL), Thailand in 2001 and 2004, respectively. He is with Lecturer at Department of Instrumentation Engineering, Faculty of Engineering, Pathumwan Institute of Technology,

Bangkok 10330, Thailand. His research interests include Control system, intelligent control.



Asst. Prof. Dr. Satean Tunyasrirut received in B.S.I.Ed. in Electrical Engineering and M.S.Tech.Ed in Electrical Technology from King Mongkut's Institute of Technology North Bangkok(KMITNB), Thailand in 1986 and 1994, respectively. In 2003 He received in B.Eng in Electrical Engineering from Rajamangala Institute of Technology Thanyaburi, Thailand and in 2007 received in D.Eng in

Electrical Engineering from King Mongkut's Institute of Technology Ladkrabang Bangkok(KMITL), Thailand, In 1995 he was awarded with the Japan International Cooperation Agency (JICA) scholarship for training the Industrial Robotics at Kumamoto National College of Technology, Japan. Since 2005, he has been a Asst. Prof at Department of Instrumentation Engineering, Pathumwan Institute of Technology, Thailand. His research interests include modern control, intelligent control, Power Electronics, Electrical Machine and Drives.