

Local Stability of Equilibria: Leptospirosis

Rujira Kongnuy

Abstract—Leptospirosis is recognized as an important zoonosis in tropical regions well as an important animal disease with substantial loss in production. In this study, the model for the transmission of the Leptospirosis disease to human population are discussed. Model is described the vector population dynamics and the Leptospirosis transmission to the human population are discussed. Local analysis of equilibria are given. We confirm the results by using numerical results.

Keywords—Eigenvalues, Leptospirosis, Local Stability, Numerical Result

I. INTRODUCTION

MATHEMATICAL model can be an important role in the development and evaluation of disease control policies. Through the 20th century, mathematical models have been established as major tools for epidemiological models [1]-[3] and particular the study of Leptospirosis infection [4]-[6].

Leptospirosis is an important re-emerging infectious disease that affects populations worldwide. Caused by pathogenic spirochaetes of the genus *Leptospira*, the disease present higher incidence in tropical and subtropical regions [7]. It is commonly overlooked as a cause either of undifferentiated fever or fulminant, multisystem disease. The severe pulmonary form of Leptospirosis manifesting as hemorrhage has globally emerged as a clinical important form of this disease [8]-[10]. It is transmitted to humans principally by environmental water contaminated with the urine of wild and domestic mammals that are chronically colonized by *Leptospira*, with infected animal tissue, or from rat bites.

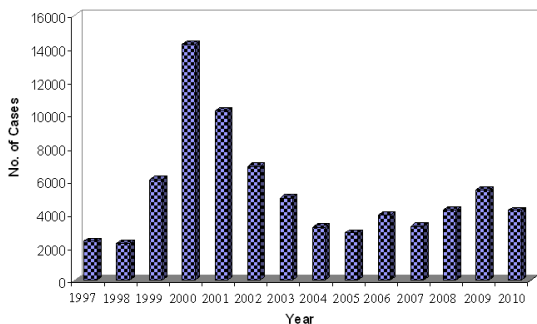

Fig. 1 Number of patients with Leptospirosis reported in Thailand from 1997 to 2010

R. Kongnuy is with the Department of Mathematics, Faculty of Science and Technology, Rajamangala University of Technology Suvarnabhumi, Nonthaburi Center, Nonthaburi, 11000 Thailand (corresponding author to provide phone: 66-02525-2684; fax: 66-02525-2682; e-mail: rujirakung@yahoo.co.th, rujira.k@rmutsb.ac.th).

The modeling, study and data analysis of the spread of Leptospirosis diseases are very useful in evaluating strategies to control such diseases in populations. In this study, we formulate and analyze the mathematical model for Leptospirosis transmission. The paper is organized as follows. Section II, is presented the mathematical formulation for Leptospirosis transmission. Then, in section III, we analyze the system solution of ordinary differential equations from obvious section. Section IV we consider the real data for numerical simulations and discuss in finally section.

II. MATHEMATICAL MODEL

In the Section II, we first mathematical model for evolution of Leptospirosis transmission in the population is formulated. We construct the model by using the basic ideas and structure of mathematical modeling in epidemiology, the model for the disease will be developed under the next basic hypotheses [11]-[13].

- i) The total human population $N(t)$ is separate in three subclasses: Susceptible human $S(t)$ is the members of the human population who may become infected. Infected human $I(t)$ is the members of human population infected by Leptospirosis disease. Recovered human $R(t)$ is the members of human population who have been immuned.
- ii) The total vector (rat) population $M(t)$ is divided into two subclasses: Susceptible vector $X(t)$ is the members of the vector population. Infected vector $Y(t)$ is the members of vector population.
- iii) The birth rate of human μ is assumed time-independent as well as the natural death rate of human d .

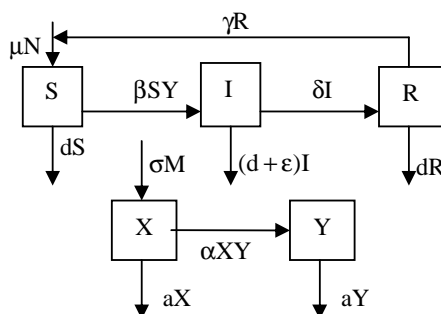

Fig. 2 Diagram of Leptospirosis transmission

TABLE I
BASIC PARAMETER OF THE MATHEMATICAL MODEL

| Symbol | Description |
|------------|--|
| μ | Birth rate of human |
| σ | Birth rate of vector |
| d | Natural death rate of human |
| a | Natural death rate of vector |
| ϵ | Death rate caused by Leptospirosis disease |
| β | Transmission rate of human from infected vector |
| α | Transmission rate of vector from infected vector |
| δ | Recovery rate of human |
| γ | Transmission rate at which the recovered human can be secondary infected |

Under the above assumptions, an epidemiological model for Leptospirosis is given by the following linear system of ordinary differential equations.

$$\begin{aligned} S'(t) &= \mu N(t) - dS(t) - \beta S(t)Y(t) + \gamma R(t), \\ I'(t) &= \beta S(t)Y(t) - (d + \epsilon + \delta)I(t), \\ R'(t) &= \delta I(t) - (d + \gamma)R(t), \\ X'(t) &= \sigma M(t) - aX(t) - \alpha X(t)Y(t), \\ Y'(t) &= \alpha X(t)Y(t) - aY(t), \\ N(t) &= S(t) + I(t) + R(t), \\ M(t) &= X(t) + Y(t), \end{aligned} \tag{1}$$

Where $S(t)$, $I(t)$, $R(t)$ represent the number of human individuals in the three subclasses at time t and $X(t)$, $Y(t)$ represent the number of vector individuals in the two subclasses at time t .

III. ANALYSIS THE MODEL

Following ideas were developed in papers [14]-[15] about how to scale models with populations varying in size, adding the first three equations of the system (1) and using the sixth equation we obtain that

$$N'(t) = (\mu - d)N - \epsilon I. \tag{2}$$

Dividing both members of (2) by N one gets

$$\frac{N'}{N} = (\mu - d) - \epsilon \frac{I}{N}. \tag{3}$$

If we define the ratios (depend on time)

$$s = \frac{S}{N}, i = \frac{I}{N}, r = \frac{R}{N}, \tag{4}$$

(3) can be transformed into

$$\frac{N'}{N} = (\mu - d) - \epsilon i. \tag{5}$$

Now, let us calculate the derivative of s using (5). Then, we obtain that

$$\begin{aligned} s' &= \frac{NS' - SN'}{N^2} \\ s' &= \frac{S'}{N} - s(\mu - d - \epsilon i) \end{aligned} \tag{6}$$

and analogously, one gets that

$$\begin{aligned} i' &= \frac{I'}{N} - i(\mu - d - \epsilon i), \\ r' &= \frac{R'}{N} - r(\mu - d - \epsilon i). \end{aligned} \tag{7}$$

Now, let us consider the first equation of system (1). If we divided by N , we have

$$\frac{S'}{N} = \mu - d - \beta \frac{S}{N} Y + \gamma \frac{R}{N} \tag{8}$$

and substituting by the corresponding ratios defined in (4) and using (8) we obtain the equation

$$s' = \mu + \gamma r - (\beta Y + \mu - \epsilon i)s. \tag{9}$$

Remaining part of the equations of system (1) can be scaled similarly to obtain

$$i' = \beta s Y - (\epsilon + \mu + d - \epsilon i)i \tag{10}$$

$$r' = \delta i + (\gamma - \mu + \epsilon i)r, \tag{11}$$

$$1 = s' + i' + r'. \tag{12}$$

Using the same method, adding the fourth and fifth equations of the system (1) and using the seventh equation we obtain that

$$M'(t) = (\sigma - a)M. \tag{13}$$

Dividing both members of (13) by M one gets

$$\frac{M'}{M} = \sigma - a. \tag{14}$$

If we define the ratios

$$x = \frac{X}{M}, y = \frac{Y}{M}. \tag{15}$$

Now, let us calculate the derivative of x using (14). Then, we obtain that

$$x' = \frac{X'}{M} - x(\sigma - a) \tag{16}$$

and analogously, one gets that

$$y' = \frac{Y'}{M} - y(\sigma - a). \tag{17}$$

Let us consider the fourth equation of system (1). If we divided by M , we have

$$\frac{X'}{M} = \sigma - a - \alpha \frac{XY}{M} \tag{18}$$

and substituting by the corresponding ratios defined in (15) and using (18) we obtain the equation

$$x' = \sigma(1 - x) - \alpha x Y. \tag{19}$$

Remaining part of the equations of system (1) can be scaled similarly to obtain

$$y' = \alpha y X - \sigma y, \tag{20}$$

$$1 = x' + y'.$$

Then we have

$$s' = \mu + \gamma r - (\beta Y + \mu - \epsilon i)s,$$

$$i' = \beta s Y - (\epsilon + \mu + d - \epsilon i)i,$$

$$r' = \delta i + (\gamma - \mu + \epsilon) r, \tag{21}$$

$$x' = \sigma(1-x) - \sigma x Y,$$

$$y' = \alpha y X - \sigma y,$$

$$1 = s' + i' + r',$$

$$1 = x' + y'.$$

Using the relations in (15) and as $s' + i' + r' = 1$, $x' + y' = 1$, we can eliminate r' and x' and consider the three-dimensional system.

$$s' = \mu + \gamma(1-s-i) - (\beta y M + \mu - \epsilon) s,$$

$$i' = \beta s y M - (\epsilon + \mu + d - \epsilon) i, \tag{22}$$

$$y' = \alpha y(1-y) M - \sigma y.$$

From the following data

1. Between 1997 and 2010 of 74,097 in Thailand have Leptospirosis infection [16]-[29].
2. There are the peak incidence rate with Leptospirosis infection in 2000.
3. Data statistics from Division of Epidemiology, Ministry of Public Health, Thailand.

IV. NUMERICAL SIMULATION

In this section, we simulate the numerical solutions all proportions. Some of the model parameters can be estimated by using the values from our previous study [6] and are summarized in below table.

TABLE II
PARAMETERS OF THE MODEL

| Parameter | Values |
|------------|------------------------------|
| μ | $1/(365 \times 70)$ per day |
| σ | $1/(365 \times 1.5)$ per day |
| d | $1/(365 \times 70)$ per day |
| M | 5000 |
| ϵ | 0.000001 |
| δ | $1/360$ per day |
| γ | 0.0001 |

We assume as initial condition in the following values $s(0) = 0.00001$, $i(0) = 0.06$, $y(0) = 0.05$. (23)

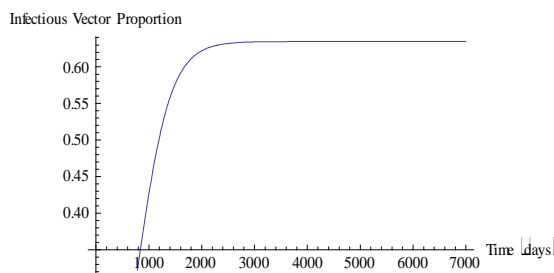
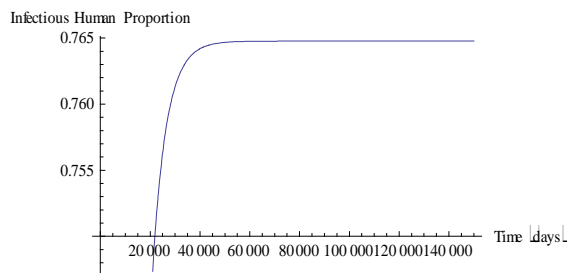
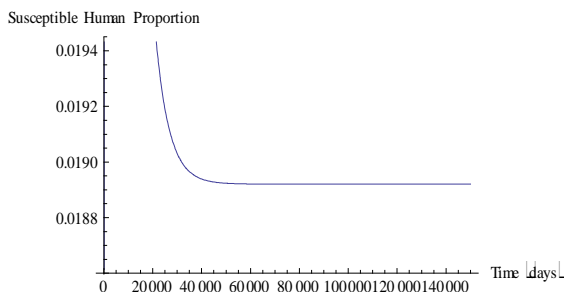

Fig. 3 Dynamics of the different subpopulations when $\beta = 0.000001$ and $\alpha = 0.000001$

TABLE III
EQUILIBRIUM STATE WHEN $\beta = 0.000001$ AND $\alpha = 0.000001$ OF SYSTEM (22)

| Equilibrium State | Values |
|-------------------|-----------|
| s^* | 0.0189204 |
| i^* | 0.7647665 |
| y^* | 0.6347032 |

TABLE IV
EIGENVALUES OF THE JACOBIAN $J(s^*, i^*, y^*)$ WHEN $\beta = 0.000001$ AND $\alpha = 0.000001$ OF SYSTEM (22)

| Eigenvalues | Values |
|-------------|------------|
| λ_1 | -11.589600 |
| λ_2 | -0.003213 |
| λ_3 | -0.000097 |

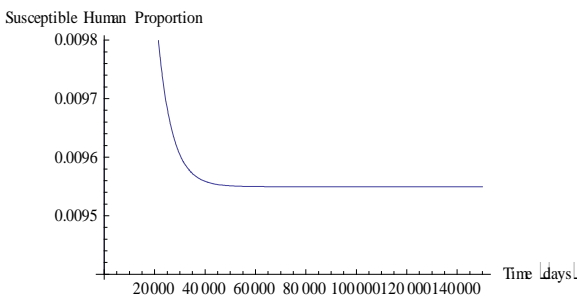

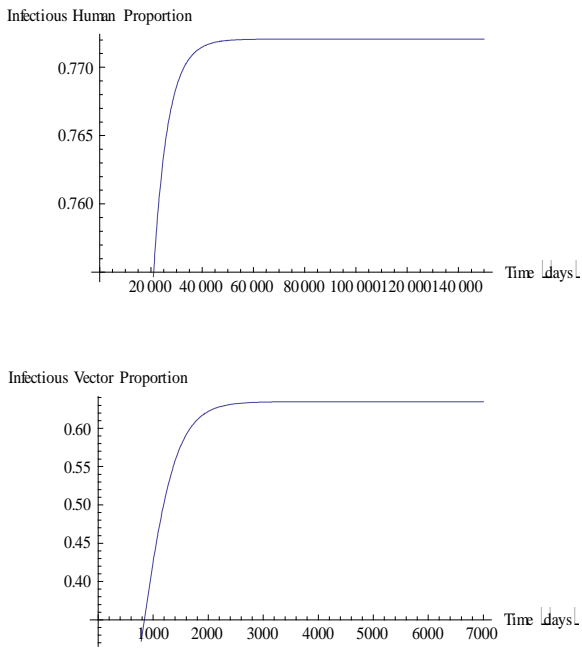

Fig. 4 Dynamics of the different subpopulations when $\beta = 0.000002$ and $\alpha = 0.000001$

TABLE V
EQUILIBRIUM STATE WHEN $\beta = 0.000002$ AND $\alpha = 0.000001$ OF SYSTEM (22)

| Equilibrium State | Values |
|-------------------|-----------|
| s^* | 0.0095496 |
| i^* | 0.7720622 |
| y^* | 0.6347032 |

TABLE VI
EIGENVALUES OF THE JACOBIAN $J(s^*, i^*, y^*)$ WHEN $\beta = 0.000002$ AND $\alpha = 0.000001$ OF SYSTEM (22)

| Eigenvalues | Values |
|-------------|------------|
| λ_1 | -11.589600 |
| λ_2 | -0.006386 |
| λ_3 | -0.000098 |

For the first simulation we consider that the spread of Leptospirosis in population is in equilibrium, proportions of susceptible, infected human and infected vector are invariant over the parameter values and other parameters are defined in Table II, $\beta = 0.000001$ and $\alpha = 0.000001$. Thus, we can compute the equilibrium state (s^*, i^*, y^*) and the jacobian $J(s^*, i^*, y^*)$ of system (23). The eigenvalues of $J(s^*, i^*, y^*)$ are negative and therefore equilibrium state (s^*, i^*, y^*) is locally asymptotically stable [30]. See Table III and VI. In fig. 4, it

can be seen that the solutions $s(t)$, $i(t)$ and $y(t)$ stay invariant over the time. In the second simulation the transmission rate $\beta = 0.000002$ is increased to the double value of the previous simulation. In Table V and VI, the equilibrium state (s^*, i^*, y^*) and the eigenvalues of the Jacobian $J(s^*, i^*, y^*)$ are showed. The obtained eigenvalues are negative, therefore the equilibrium state is locally asymptotically stable.

V. CONCLUSION

In this model, we study the Leptospirosis transmission by using the mathematical model. The model is divided the human population into three subclasses and vector population into two subclasses. We use the system of ordinary differential equation for analyzing. The numerical simulations of the model are shown in fig. 3 and fig. 4. We can see from the dynamic of Leptospirosis infection when β is increase, the infected human proportion is increase too. Moreover, we compare the numerical simulation when α increase in below figure.

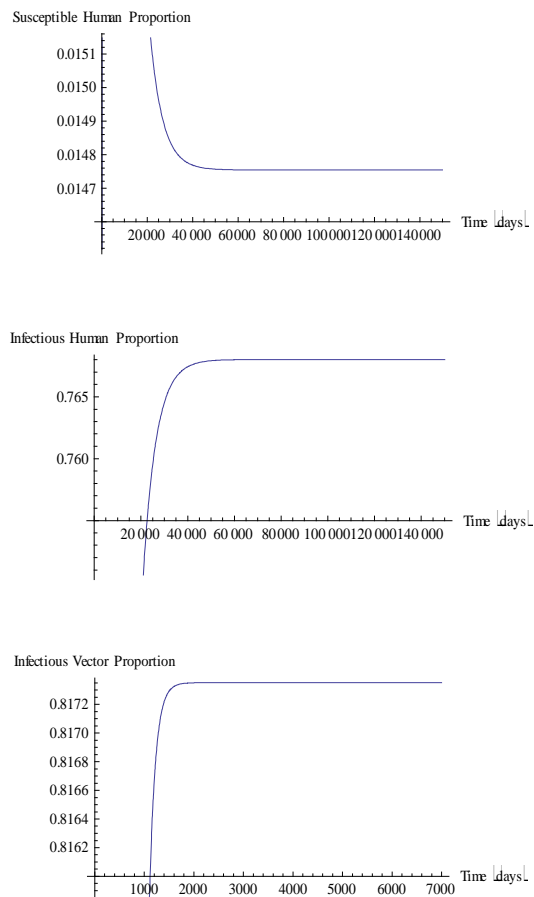

Fig. 5 Dynamics of the different subpopulations when $\beta = 0.000001$ and $\alpha = 0.000002$

We can see in fig.5 for the third simulation, we consider all proportions when the transmission rate of vector from infected vector (α) is increased to the double value of the the first simulation. It is possible to see that the solution $s(t)$, $i(t)$ and $y(t)$ converge to the equilibrium state 0.0147541, 0.7680102, 0.8173516, respectively. We can see, infected human and infected vector increase. So, the controlling in Leptospirosis transmission is good when we can control the transmission rate of vector from infected vector or the transmission rate of human from infected vector are decreases.

ACKNOWLEDGMENT

This work is supported by Rajamangala University of Technology Suvarnabhumi and National Research Council of Thailand. The author would like to thank Assist. Prof. Dr. Puntani Pongsumpun at King Mongkut's Institute of Technology Ladkrabang, Bangkok and Prof. Dr. I-Ming Tang at Mahidol University, Bangkok, Thailand.

REFERENCES

- [1] R. Ross, *The Prevention of Malaria*, Second Edition, Murray, London.
- [2] G. MacDonald, *The Epidemiology and Control of Malaria*, Oxford University Press, London, 1957.
- [3] F. E. McKenzie, "Why model malaria?," *Parasitology Today*, vol. 16, pp. 511-516, 2000.
- [4] J. Holt, S. Davis and H. Leirs, "A model of Leptospirosis infection in African rodent to determine risk to human: Seasonal fluctuations and the impact of rodent control," *ACTA TRPICA*, vol. 99, pp. 218-225, 2006.
- [5] W. Triampo, D. Baowan, I. M. Tang, N. Nuttavut, J. Wong Ekkabut and G. Doungchawee, "A Simple Deterministic model for the spread of leptospirosis in Thailand," *International Journal of Biomedical Sciences*, vol. 2, pp. 170-174, 2007.
- [6] R. Kongnuy, "Mathematical Model for Leptospirosis Transmission by Provinces in Thailand," *The proceeding of International Conference in Mathematics and Applications*, Vietnam, pp. 198-218, 2011.
- [7] A. R. Bharti, J. E. Nally, J. N. Ricaldi, M. A. Matthias, M. M. Diaz, M. A. Lovett and et al., "Peru-United States Leptospirosis Consortium Leptospirosis: a zoonotic disease of global importance," *Lancet Infect Dis*, vol. 3, pp. 757-771, 2003.
- [8] C. Yersin, P. Bovet, F. Merien and et al, "Pulmonary haemorrhage as a predominant cause of death in leptospirosis in Seychelles," *Trans R Soc Trop Med Hyg*, vol. 94, pp. 71-76, 2000.
- [9] R. T. Trevejo, J. G. Rigau-Perez, D. A. Ashford and et al, "Epidemic leptospirosis associated with pulmonary hemorrhage Nicaragua," *J Infect Dis*, vol. 178, pp. 1457-1463, 1998.
- [10] P. C. Marotto, C. M. Nascimento, J. Eluf-Neto and et al, "Acute lung injury in leptospirosis: clinical and laboratory features, outcome, and factors associated with mortality," *Clin Infect Dis*, vol. 29, pp. 1561-1563, 1999.
- [11] J. D. Murray, *Mathematical biology I. An Introduction*. USA, 2002.
- [12] F. Brauer, C. Castillo-Chavez, *Mathematical models in population biology and epidemiology*. Springer-Verlag, New York, 2001.
- [13] H. W. Hethcote, "Mathematics of infectious diseases," *SIAM Rev*, vol. 42, pp. 599-653, 2000.
- [14] M. Martcheva and C. Castillo Chavez, "Diseases with chronic stage in population with varying size," *Math Biol*, vol. 182, pp. 1-25, 2003.
- [15] J. Mena-Lorca and H. W. Hethcote, "Dynamic model of infectious diseases as regulators of population size," *J. Math Biol*, vol. 30, pp. 693-716, 1992.
- [16] Division of Epidemiology, *Annual Epidemiological Surveillance Report*, Ministry of Public Health, Thailand, 1997.
- [17] Division of Epidemiology, *Annual Epidemiological Surveillance Report*, Ministry of Public Health, Thailand, 1998.
- [18] Division of Epidemiology, *Annual Epidemiological Surveillance Report*, Ministry of Public Health, Thailand, 1999.
- [19] Division of Epidemiology, *Annual Epidemiological Surveillance Report*, Ministry of Public Health, Thailand, 2000.
- [20] Division of Epidemiology, *Annual Epidemiological Surveillance Report*, Ministry of Public Health, Thailand, 2001.
- [21] Division of Epidemiology, *Annual Epidemiological Surveillance Report*, Ministry of Public Health, Thailand, 2002.
- [22] Division of Epidemiology, *Annual Epidemiological Surveillance Report*, Ministry of Public Health, Thailand, 2003.
- [23] Division of Epidemiology, *Annual Epidemiological Surveillance Report*, Ministry of Public Health, Thailand, 2004.
- [24] Division of Epidemiology, *Annual Epidemiological Surveillance Report*, Ministry of Public Health, Thailand, 2005.
- [25] Division of Epidemiology, *Annual Epidemiological Surveillance Report*, Ministry of Public Health, Thailand, 2006.
- [26] Division of Epidemiology, *Annual Epidemiological Surveillance Report*, Ministry of Public Health, Thailand, 2007.
- [27] Division of Epidemiology, *Annual Epidemiological Surveillance Report*, Ministry of Public Health, Thailand, 2008.
- [28] Division of Epidemiology, *Annual Epidemiological Surveillance Report*, Ministry of Public Health, Thailand, 2009.
- [29] Division of Epidemiology, *Annual Epidemiological Surveillance Report*, Ministry of Public Health, Thailand, 2010.
- [30] M. W. Hirsch, S. Smale and R. L. Devaney, *Differential Equations, Dynamical Systems and An Introduction to Chaos*. USA, 2004.

R. Kongnuy, I was born in Thailand on June, 20, 1976. My educational background: I was earned Ph.D. (Applied Mathematics) 2009 King Monkut's Institute of Technology Ladkrabang, Bangkok, Thailand, M.Sc. (Mathematics) 2005 Ramkhamhaeng University, Bangkok, Thailand, B.Sc. (Mathematics) First Class Honor 1998 Prince of Songkla University, Songkla, Thailand.

I'm a Lecture at Department of Mathematics, Faculty of Science and Technology, Rajamangala University of Technology Suvarnabhumi, Nonthaburi Campus since 2000. My publications: 'Model for the transmission of dengue disease in pregnant and non-pregnant patients', *International Journal of Mathematical Models and Methods in Applied Sciences*, vol. 1, pp. 127-132, 2007. 'Analysis of a Mathematical Model for Dengue Disease in Pregnant Cases', *International Journal of Biological and Medical Sciences*, vol. 3, pp. 192-199, 2008. 'Mathematical Model for Dengue Disease with Maternal Antibodies', *International Journal of Biological and Medical Sciences*, vol. 1, pp. 5-14, 2010. Analysis of a dengue transmission model with clinical diagnosis in Thailand", *International Journal of Mathematical Models and Methods in Applied Science*, vol 5, pp. 594-601, 2011.