

Robust Design of Power System Stabilizers Using Adaptive Genetic Algorithms

H. Alkhatib, and J. Duveau

Abstract—Genetic algorithms (GAs) have been widely used for global optimization problems. The GA performance depends highly on the choice of the search space for each parameter to be optimized. Often, this choice is a problem-based experience. The search space being a set of potential solutions may contain the global optimum and/or other local optimums. A bad choice of this search space results in poor solutions. In this paper, our approach consists in extending the search space boundaries during the GA optimization, only when it is required. This leads to more diversification of GA population by new solutions that were not available with fixed search space boundaries. So, these dynamic search spaces can improve the GA optimization performances. The proposed approach is applied to power system stabilizer optimization for multimachine power system (16-generator and 68-bus). The obtained results are evaluated and compared with those obtained by ordinary GAs. Eigenvalue analysis and nonlinear system simulation results show the effectiveness of the proposed approach to damp out the electromechanical oscillation and enhance the global system stability.

Keywords—Genetic Algorithms, Multiobjective Optimization, Power System Stabilizer, Small Signal Stability.

I. INTRODUCTION

SMALL signal stability enhancement, in particular the inter-area oscillation damping, has become more and more a priority. Due to their flexibility, easy implementation and low cost, power system stabilizers (PSSs) stay the most used devices to enhance small signal stability [1-2].

Genetic algorithms (GAs) are powerful global optimization methods. Independent of the problem complexity, their only requirements are to specify an objective function and to place finite bounds on the parameters to be optimized. Thus, they are widely used for robust PSS tuning in multimachine power system [3-8].

Several methods, such as self-adaptive GA operators [9-11], parallel GAs [12-13], and others, are proposed in the literature to improve GA performance in searching for the global optimum. Good results can be obtained by these methods. But, if the sought global optimum is being existed outside the proposed search space of the problem, none of these methods can allow GAs to find this optimum.

H. ALKHATIB is with the Electromagnetic Compatibility Laboratory of Marseille, Paul Cézanne University (Aix-Marseille III), France (e-mail: hasan.alkhatib@univ-cezanne.fr).

J. DUVEAU is with the Electromagnetic Compatibility Laboratory of Marseille, Paul Cézanne University (Aix-Marseille III), France (e-mail: jean.duveau@univ-cezanne.fr).

The high dependence of the GA performance on the determination of search space boundaries for each parameter to be optimized makes the optimization critical. A bad choice of these boundaries leads to poor solutions. To resolve this problem, an approach allowing the extending of the search space boundaries during the GA running, only when it is required, is proposed. So, the GA can diversify its population by new values that were not available with fixed search space boundaries. Thus, these dynamic search spaces allow significant improvement to GAs in terms of optimal solution and convergence rate.

The proposed approach is applied for optimal PSS tuning to enhance the global system stability of the interconnected multimachine power system of New England/New York (16-generator and 68-bus), [14]. The problem is formulated as GA optimization problem using eigenvalue-based multiobjective function.

II. PROBLEM STATEMENT

A widely used conventional lead-lag PSS is considered in this study [1]. Its transfer function, given in (1), consists of an amplification block with a control gain K , a washout filter block with a time constant T_w and two lead-lag blocks for phase compensation with time constants T_1 , T_2 , T_3 , and T_4 .

$$V_{PSS}(s) = K \cdot \frac{sT_w}{1+sT_w} \cdot \left[\frac{(1+sT_1)}{(1+sT_2)} \cdot \frac{(1+sT_3)}{(1+sT_4)} \right] \cdot \Delta\omega(s) \quad (1)$$

Where, the PSS output signal, V_{PSS} , is a voltage added to the generator exciter input. The generator speed deviation $\Delta\omega$ is often used as the PSS input signal.

In small signal stability studies, the linearized system model around an equilibrium point and the eigenvalue analysis are usually applied [1].

The real part (σ) of an eigenvalue (λ), given in (2), and the related damping factor (ζ), given in (3), are two important criteria for the system stability performance [1]. To get good results, it is preferred to take into account these two criteria. This combination leads to a D-stability region of the complex s-plane, where all system eigenvalues must be placed [3]. The D-stability criteria are chosen as following:

$$\sigma_{cr} = -1, \zeta_{cr} = 10\%.$$

$$\lambda = \sigma \pm j\omega \quad (2)$$

$$\zeta = \frac{-\sigma}{\sqrt{\sigma^2 + \omega^2}} \quad (3)$$

III. PROPOSED APPROACH

Generally, an optimization problem may be formulated mathematically as following:

$$\begin{aligned} & \text{maximize } f(x) ; \quad x \in \mathcal{R}^n \\ & x_{i,\min} \leq x_i \leq x_{i,\max} \quad ; \quad i = \{1, 2, \dots, n\} \end{aligned} \quad (4)$$

- $f(x)$ is the objective (or multiobjective) function.
- x is the vector of the n parameters to be optimized.
- $x_{i,\min}$ and $x_{i,\max}$ are the search space boundaries of the associated parameter x_i .

In our problem, the multiobjective function $f(x)$ is formulated, as given in (5), to optimize a composite set of two eigenvalue-base objective functions; comprising eigenvalue real part (σ) and damping factor (ζ) of the system dominate electromechanical modes.

$$f(x) = -\max(\sigma) + \min(\zeta) \quad (5)$$

The PSS parameters determined to be optimized are (K , T_l , and T_3). The PSS parameters (T_2 , T_4 , and T_w) are considered fixes; their values are given in Tables II, appendix.

During the optimization running, the values of one or more associated parameters can reach one of the search space boundaries. This can happen after many generations or even from the beginning of the optimization. But, the optimal parameter value may exist outside the associated search space boundaries. As a result, the evolution of the objective function will decelerate converging to a local optimal solution.

The proposed approach is based on the release of search space boundaries, during the GA running, and giving them different values depending on the optimization process needs. As a result, the GA population can be diversified by new values that were not available while using fixed search space boundaries. So, this approach creates dynamic search spaces that are adaptable to the searching for the global optimum.

In the proposed approach algorithm, shown in Fig. 1, the GA optimization is initialized with fixed search space boundaries $[x_{i,\min}, x_{i,\max}]$. Tolerance margins (ϵ_m , ϵ_n) are set for both boundaries of the search space parameters. When the value of a parameter to be optimized attains the associated tolerance margin, in many consecutive generations (N_{gener}), this means that the optimal value may exist beyond the initial boundary. In this case, this related boundary will be modified by predetermined values (Δ_m , Δ_n). The parameter search space moves by always keeping its initial size. This process can be occurred several times in the course of the optimization. Thus, the related search space will be expanded gradually. Finally, in order for the parameter values to be feasible solutions, the increase and the decrease of search space boundaries should be limited to maximum and minimum values (Ω_m , Ω_n).

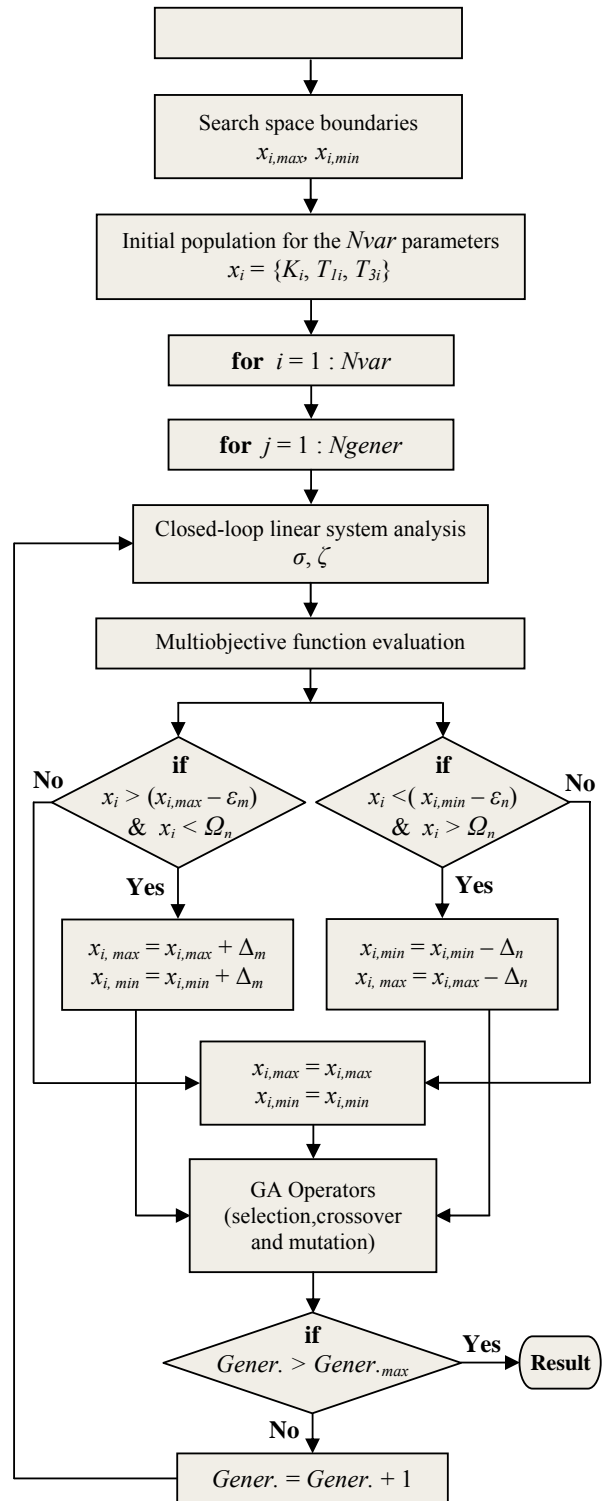

Fig. 1 Proposed approach algorithm

IV. RESULTS AND DISCUSSION

To validate the effectiveness of the proposed approach, many applications on several multimachine power systems having different sizes have been done. In this paper, the results of a relatively large size power system which is the New England/New York interconnected system (16-generator and 68-bus), (Fig. 9, appendix), is presented. Details of the system data can be found in [14].

The obtained results of the proposed approach have been evaluated and compared to ordinary genetic algorithm results of our previous publications [15-16].

A. Open-loop system analysis (no PSS)

A linear representation of the open-loop system is formed around the studied nominal operating point. The repartition of the system dominant electromechanical modes without PSSs is given in Fig. 2. It shows clearly that the system is unstable.

The first conventional step in PSS design is to identify the best PSS locations. The participation factor method has been widely used to find the best effective generators for installing PSSs. The application of this method shows that 14 generators are mainly involved in the system dominant modes and they must be equipped with PSSs.

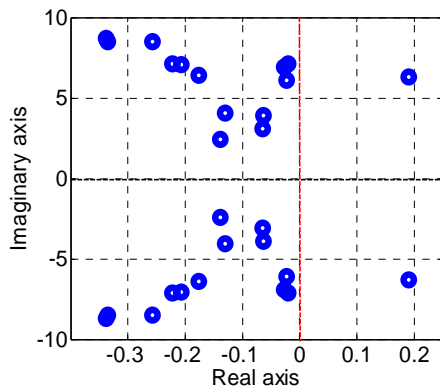

Fig. 2 Electromechanical modes of open-loop system

B. PSS design by GA-based fixed search spaces

The coordinated synthesis of PSS parameters is optimized using an ordinary GA. The GA parameter setting is given Table III, appendix. The search space boundaries of the optimized 42 PSS parameters stay fixed throughout the optimization process. They are given as following:

$$\begin{aligned}
 1 &\leq K_i \leq 40 \\
 0.01 &\leq T_{1,i} \leq 1 \\
 0.01 &\leq T_{3,i} \leq 1 \\
 i &= 1, 2, \dots, N_{PSS} \ ; \ N_{PSS} = 14
 \end{aligned}
 \tag{6}$$

The optimized PSS parameters' values are given in Table IV, appendix.

The multiobjective function evolution as a function of generation number is given in Fig. 3. The multiobjective function attains at the end of the optimisation a value of 1.153. But, it is clear that the convergence rate decreases significantly from the 150th generation.

Fig. 4 gives the electromechanical mode repartition of the closed-loop system. It is noticed that all modes are shifted in the D-stability region. The minimum damping factor and the maximum eigenvalue real part are respectively: $\zeta_{min} = 16.2\%$, $\sigma_{max} = -0.99$.

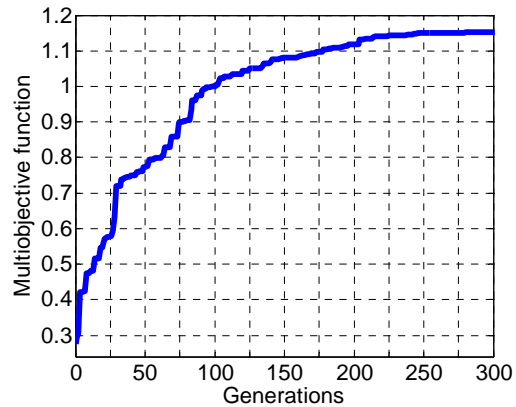

Fig. 3 Multiobjective function evolution

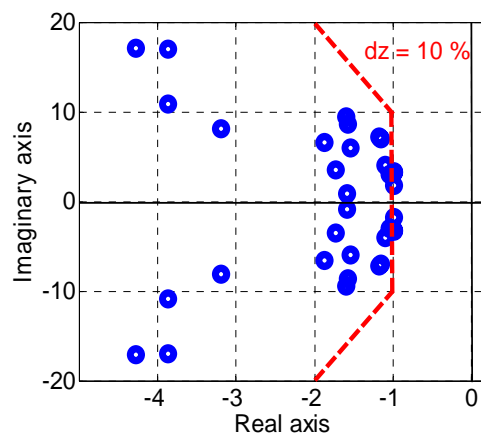

Fig. 4 Electromechanical modes of closed-loop system

C. PSS design by GA-based dynamic search spaces

The proposed approach based on dynamic search spaces is now applied. For the optimization initialization, the same search spaces used in the ordinary GA optimization, as given in (6), is taken. The same fixed PSS parameters' values and the same GA parameter setting, (Tables II and III, appendix), are also used. The optimized PSS parameters' values are given in Table IV, appendix.

This application shows clearly that the expansion of some

optimized parameters beyond their initial search space boundaries allows a well improving in the multiobjective function evolution, as shown as in Fig. 5. In this case, the multiobjective function attains rapidly, at the 110th generation, a value of 1.153 which is equal to the final value in the previous case. Then, it continues to improve and attains a value of 1.345 at the end of the optimization.

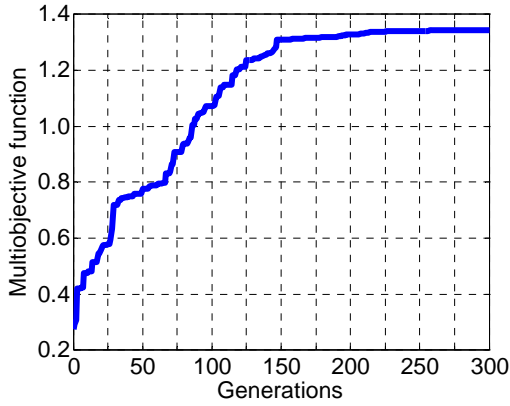

Fig. 5 Multiobjective function evolution

To evaluate the optimization effectiveness, in terms of optimal multiobjective function value and convergence rate, the following table summarizes a comparison of the obtained results of the GA-based:

- fixed search space boundaries (FSSB),
- dynamic search space boundaries (DSSB).

TABLE I
RESULT COMPARISON

	FSSB	DSSB
Optimal multiobjective function value	1.153	1.345
Relative Optimal value % (compared to FSSB)	—	16.6%
Relative convergence rate % (compared to FSSB)	—	60%

By way of an example, Fig. 6 illustrates the optimization evolution of the PSS parameter $K_{(13)}$ (PSS connected to the generator 67) when using fixed search space boundaries and then when using dynamic search spaces boundaries.

- On the Fig. 6-a, the PSS gain $K_{(13)}$ attains and remains, from the 125th generation generally, at values that are very close to the maximum boundary of the related search space.
- Contrariwise, on the Fig. 6-b, the gain takes, from the 150th generation, new values that are higher than the initial maximum boundary of the related search space. The final value is 45.34.

This can demonstrate clearly the approach effectiveness in finding the optimal parameter values against the problem arisen when using fixed search space boundaries.

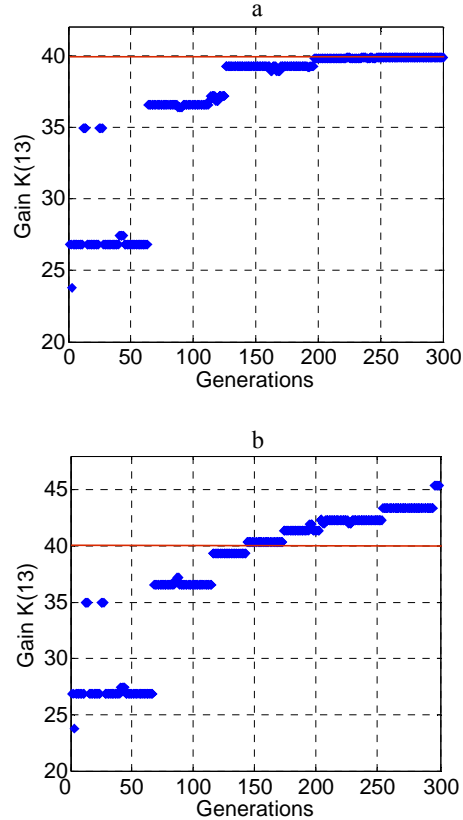

Fig. 6 Optimization evolution of the PSS parameter ($K_{(13)}$):
a: using fixed search space boundaries
b: using dynamic search space boundaries

Concerning the optimization effectiveness in enhancing the global system stability, this can be confirmed by the eigenvalue analysis and nonlinear system simulations.

For eigenvalue analysis, Fig. 7 illustrates the system electromechanical mode repartition in the complex s-plane. It is clear that all modes are well shifted in the D-stability region with $\zeta_{min} = 14.48\%$ and $\sigma_{max} = -1.2$.

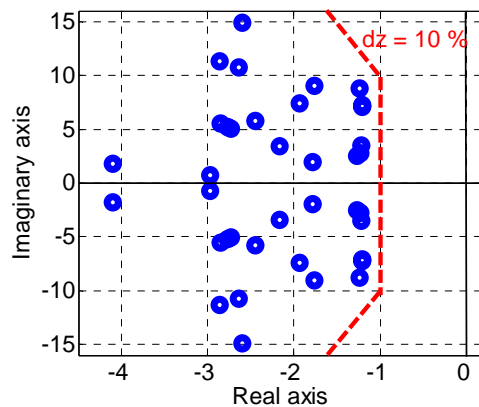

Fig. 7 Electromechanical modes of closed-loop system

The nonlinear time domain simulations were carried out for a three phase-fault, with duration of 100 ms on the line 25#60, assuming also that the two lines (16#17 and 25#26) are out of service. The performance of the PSSs tuned based on dynamic search spaces is compared to that of the PSSs tuned using fixed search spaces. The speed deviations of generators G.53, G.56, G.60, and G.68, under the proposed fault, are shown in Fig. 8.

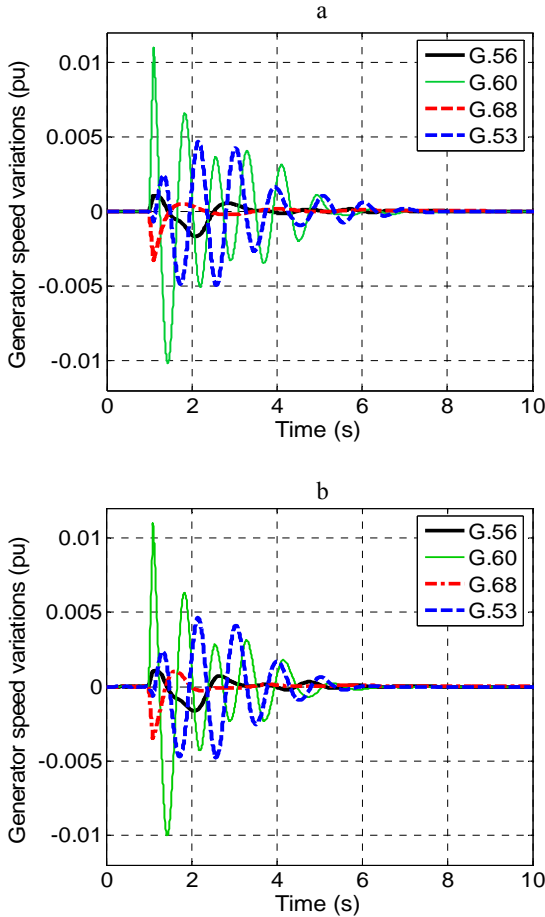

Fig. 8 Generator speed variations under a big disturbance:
 a: based fixed search space optimization
 b: based dynamic search space optimization

To demonstrate the system performance robustness of the proposed method, the performance index, Integral of Time multiplied Absolute value of Error (ITAE), is being used as:

$$ITAE = \int_0^{10} t \cdot (|\Delta\omega_1| + |\Delta\omega_2| + \dots + |\Delta\omega_{16}|) \cdot dt \quad (7)$$

It is worth mentioning that the lower the value of this index is, the better the system response in terms of time-domain characteristics.

Applying this index relation on the optimization-based dynamic search spaces gives $ITAE_{(DSSB)} = 25.83$. On the other

hand, the index value for the optimization-based fixed search spaces is $ITAE_{(FSSB)} = 48.80$.

Thus, it can be clearly proved the superiority of the system performance robustness in term of ‘ITAE’ index when using the optimization approach based on dynamic search spaces compared to the optimization-based fixed search spaces.

V. CONCLUSION

In this paper, an approach of GA optimization-based dynamic search space boundaries has been proposed. The approach effectiveness is validated on multimachine PSS tuning for enhancing power system stability. In the ordinary GA, the optimization performance is often restricted by the choice of the search space boundaries of the parameters to be optimized. In our approach, the possibility to overcome this problem has been proved by releasing the search space boundaries during the optimization running. The PSS parameters of the New England/New York multimachine power system are optimized via GA-based dynamic search space approach and compared to the results obtained when using fixed search spaces. The analysis of the multiobjective function evolution shows that a well improvement in the GA performance and convergence can be then obtained. Thus, it is possible to make the GA optimization independent of the initial choice of search space boundaries. The eigenvalue analysis and nonlinear system simulations are also carried out. A well enhancement of the system performance characteristics is remarked in terms of performance robustness and global system stability.

APPENDIX

TABLE II
 PSS FIXED PARAMETERS

T_{wi}	T_{2i}	T_{4i}
10	0.1	0.05

TABLE III
 GA PARAMETER SETTING

Population size	75
Variable number / PSS	3
Crossover probability P_c	0.9
Mutation probability P_m	0.005
Generation number	300

TABLE IV
 PSS OPTIMIZED PARAMETERS

N° PSS	N° G.	GA optimization-based fixed search spaces			GA optimization-based dynamic search spaces		
		K	T_1	T_3	K	T_1	T_3
1	53	38.99	0.856	0.846	25.10	0.914	1.070
2	54	16.74	0.505	0.328	16.21	0.879	0.455
3	55	38.98	0.817	0.634	21.79	0.847	0.200
4	56	13.62	0.501	0.256	05.70	0.253	0.443
5	57	10.64	0.121	0.257	10.56	0.133	0.249
6	59	03.51	0.506	0.127	08.54	0.198	0.161
7	60	20.60	0.550	0.379	21.36	0.937	0.492
8	61	03.00	0.997	0.145	12.90	0.708	0.041
9	62	05.06	0.995	0.748	22.13	0.716	0.055

10	63	01.26	0.731	0.168	09.78	0.065	0.321
11	64	39.56	0.909	0.084	13.04	0.433	0.200
12	65	38.73	0.395	0.095	41.48	0.453	0.086
13	67	39.86	0.272	0.026	45.34	0.162	0.004
14	68	37.97	0.135	0.197	47.20	0.012	0.228

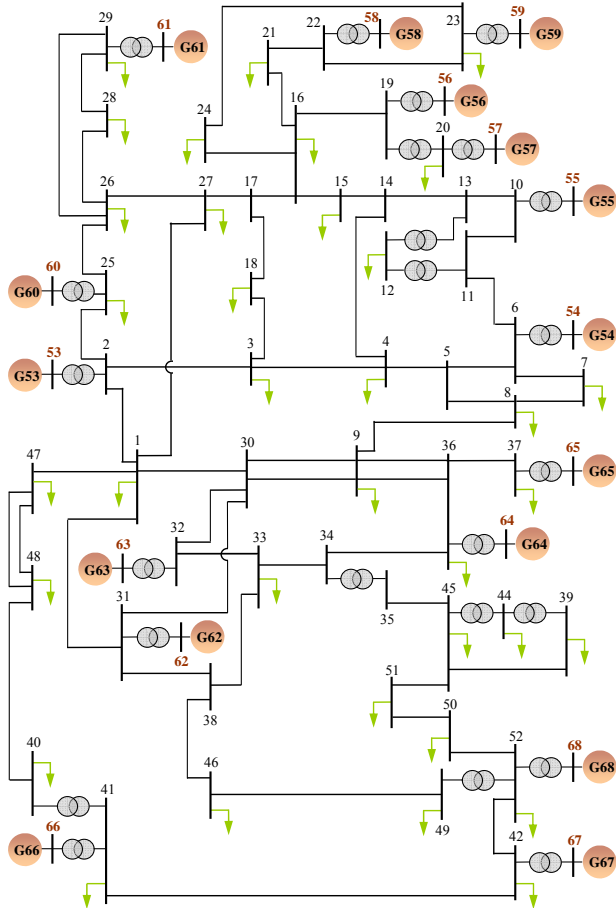

Fig. 9 A single line representation of a 16-generator and 68-bus power system

REFERENCES

- [1] P. Kundur, *Power System Stability and Control*. The EPRI Power System Engineering Series, McGraw-Hill, Inc., 1994.
- [2] E.V. Larsen, and D.A. Swann, "Applying power system stabilizers," *IEEE Trans. Power App. Sys.*, vol. 100, no. 6, pp. 3017-3046, 1981.
- [3] Y.L. Abdel-Magid, and M.A. Abido, "Optimal Multiobjective Design of Robust Power System Stabilizers Using Genetic Algorithms," *IEEE Trans. Power System*, vol. 18, n^o. 3, pp. 1125-1132, Aug. 2003.
- [4] K. Hongesombut, and Y. Mitani "Implementation of Advanced Genetic Algorithm to Modern Power System Stabilization Control," *IEEE PES, Power Sys*, vol. 2, pp.1050-1055, Oct. 2004.
- [5] K. Hongesombut, S. Dechanupaprittha, Y. Mitani, and I. Ngamroo, "Robust power system stabilizer tuning based on multiobjective design using hierarchical and parallel micro genetic algorithm," in *Proc. 15th Power Systems Computation Conference: PSCC*, Liege, Aug. 2005.
- [6] K. Hongesombut, Y. Mitani, and K. Tsuji, "Power System Stabilizer Tuning in Multimachine Power System Based on a Minimum Phase Control Loop Method and Genetic Algorithm," in *Proc. 14th Power Systems Computation Conference: PSCC*, pp. 1-7, Sevilla, Jun. 2002.
- [7] S. Panda, and N. Prasad Padhy, "Power system with PSSs and FACTS Controller: Modelling, Simulation and Simultaneous Tuning Employing Genetic Algorithm," *International Journal of Electrical, Computer and Systems Engineering*, vol.1, No. 1, pp.9-18, 2007.
- [8] F. Rashidi, and M. Rashidi, "Tuning of Power System Stabilizers via Genetic Algorithm for Stabilization of Power Systems," in *Proc. Innovations in Applied Artificial Intelligence*, pp. 1210-1219, Berlin 2004.
- [9] T. Bäck, "Self-adaptation in genetic algorithms," in *Proc. of the first European Conference on Artificial Life*, pp. 263-271, Cambridge, 1992.
- [10] P.J. Angeline, "Adaptive and Self-Adaptive Evolutionary Computations," in *Computational Intelligence: A Dynamic Systems Perspective*, pp. 152-163, IEEE Press, 1995.
- [11] É. Pellerin, L. Pigeon, and S. Delisle, "Self-Adaptive Parameters in Genetic Algorithms," *Data Mining and Knowledge Discovery: Theory, Tools, and Technology VI*, USA, vol. 5433, pp. 53-64, 12-16 Apr. 2004.
- [12] E. Alba, and J.M. Troya, "A survey of parallel distributed genetic algorithms," *Complexity*, vol. 4, no. 4, pp. 31-52, 1999.
- [13] M. Tomassini, "Parallel and Distributed Evolutionary Algorithms: A Review," in *Evolutionary Algorithms in Engineering and Computer Science*, pp. 113-133, J. Wiley and Sons, Chichester, 1999.
- [14] G. Rogers, *Power System Oscillations*, Boston, Kluwer Academic Publishers. 2000.
- [15] H. Alkhatib, J. Duveau, A. Choucha, A. Hellal, and S. Arif, "Optimisation Globale de la Performance des Stabilisateurs de Puissance par Algorithmes Génétiques," in *Proc. 5th International Conference on Electrical Engineering CEE'2008*, Batna, 27-29 Oct. 2008.
- [16] A. Choucha, H. Alkhatib, J. Duveau, A. Hellal, and S. Arif, "Multiobjective GA to Simultaneous Coordinated Tuning PSS and Location for Multimachine Power Systems," in *Proc. XVIII International Conference on Electrical Machines ICM'08*, Vilamoura, 6-9 Sep. 2008.