

Speed Control of a Permanent Magnet Synchronous Machine (PMSM) Fed by an Inverter Voltage Fuzzy Control Approach

Jamel Khedri, Mohamed Chaabane, Mansour Souissi and Driss Mehdi

Abstract—This paper deals with the synthesis of fuzzy controller applied to a permanent magnet synchronous machine (PMSM) with a guaranteed H_∞ performance. To design this fuzzy controller, nonlinear model of the PMSM is approximated by Takagi-Sugeno fuzzy model (T-S fuzzy model), then the so-called parallel distributed compensation (PDC) is employed. Next, we derive the property of the H_∞ norm. The latter is cast in terms of linear matrix inequalities (LMI's) while minimizing the H_∞ norm of the transfer function between the disturbance and the error (T_{ev}). The experimental and simulations results were conducted on a permanent magnet synchronous machine to illustrate the effects of the fuzzy modelling and the controller design via the PDC.

Keywords—Feedback controller, Takagi-Sugeno fuzzy model, Linear Matrix Inequality (LMI), PMSM, H_∞ performance.

I. INTRODUCTION

THE classical methods of control proved their effectiveness in many problems of industrial regulation. The methods of advanced control developed by many theoreticians (adaptive control, predictive control, robust control...) allow replying to the requirements of a number of these highly nonlinear systems. This is in this framework that methods of modelling and fuzzy control are positioned.

Many presented approaches have been proposed to tune fuzzy controllers. Many of these techniques are adapted to SISO (single input, single output) [1]-[5] systems as well as their stability study and their performances. But it is highly desirable to extend this technique for MIMO (multi inputs, multi outputs) systems [6]-[8].

The basic idea in our approach is to represent a non linear process by a Takagi-Sugeno fuzzy linear model.

Particularly, an original approach has been proposed by (Morère, 2000) [9] and equivalently by (Chaabane and Souissi, 2004) [10], [11]

The interest of this last representation is its simplicity due

J. Khedri, M. Souissi and M. Chaabane are with University of Sfax, ENIS, Electrical Engineering Department, Route de Soukra, km3.5, 3018 Sfax, Tunisia, (Email:Chaabane_uca@yahoo.fr).

D. Mehdi is with University of Poitiers, ESIP-LAII, 40 Av. Du Recteur Pineau, 86022 Poitiers, France (Email:Driss.Mehdi@univ-poitiers)

Manuscript received April 18, 2010.

to its linear model and then the easy use of Linear Matrix Inequality (LMI) to develop a stabilizing linear control law.

Once stabilization is achieved, we take an interest on the exploitation of the properties of H_∞ norm in order to guarantee some performance criteria such as disturbance rejection and good monitoring of the deposit.

The paper is organized as follows:

In section 2 we define the problem formulation. Section 3 deals with the synthesis of fuzzy control law with H_∞ performance. Finally, in section 4, an experimental study was conducted on a permanent magnet synchronous machine (PMSM) to illustrate the proposed method.

Notations

$\text{sym}\{X\} = X + X^T$ and the symbol *: means the transposed

II. PROBLEM FORMULATION

A nonlinear system can be approximated by a Takagi-Sugeno (T-S) fuzzy model. The T-S fuzzy model is a piecewise interpolation of several linear models through membership functions. The following fuzzy dynamic model is employed to represent a complex multi-input multi-output continuous-time system with both fuzzy inference *If-Then* rules and local analytic linear models as follows [14]-[17]:

Plant Rule i:

If $z_1(t)$ is F_{i1} and $z_2(t)$ is F_{i2} ...and $z_p(t)$ is F_{ip}

Then $\dot{x}(t) = A_i x(t) + B_i u(t) + D_i w(t)$ (1)

$y(t) = C_i x(t)$

for $i = 1, 2, \dots, r$

where $x(t) = [x_1(t), x_2(t), \dots, x_n(t)]^T \in R^{n \times 1}$ denotes the state vector; $u(t) = [u_1(t), u_2(t), \dots, u_m(t)]^T \in R^{m \times 1}$ denotes the control input; $w(t) = [w_1(t), w_2(t), \dots, w_n(t)]^T \in R^{n \times 1}$ denotes bounded external disturbance; F_{ij} is the fuzzy set, $A_i \in R^{n \times n}$,

$B_i \in R^{n \times m}$ are system and input matrix respectively, r is the number of *If-Then* rules and $z_1(t), z_2(t), \dots, z_p(t)$ are the premise variables.

Each conclusion part represents a sub model of the system. For each sub model is assigned a weight $\lambda_i(z(t))$, which depends on the degree of belonging variables premises $z_i(t)$ to sub- fuzzy sets F_{ij} and choice of interpretation of the operator “and” connecting the premises.

In this type of model, the product is chosen to model this operator:

$$\lambda_i(z(t)) = \prod_{j=1}^p F_{ij}(z(t))$$

With :

$$\begin{cases} \sum_{i=1}^r \lambda_i(z(t)) > 0 \\ \lambda_i(z(t)) \geq 0 \end{cases}$$

The final output of fuzzy models is inferred by a barycentric defuzzification [18]-[23]:

$$\begin{aligned} \hat{x}(t) &= \frac{\sum_{i=1}^r \lambda_i(z(t))(A_i x(t) + B_i u(t) + D_i w(t))}{\sum_{i=1}^r \lambda_i(z(t))} \\ y(t) &= \frac{\sum_{i=1}^r \lambda_i(z(t))C_i x(t)}{\sum_{i=1}^r \lambda_i(z(t))} \end{aligned} \tag{2}$$

If we set, $h_i(z(t)) = \frac{\lambda_i(z(t))}{\sum_{i=1}^r \lambda_i(z(t))}$, satisfying $\forall t$ a convex sum

property:

$\sum_{i=1}^r h_i(z(t)) = 1$, the final output can be rewritten:

$$\begin{aligned} \hat{x}(t) &= \sum_{i=1}^r h_i(z(t))(A_i x(t) + B_i u(t) + D_i w(t)) \\ y &= \sum_{i=1}^r h_i(z(t))C_i x(t) \end{aligned} \tag{3}$$

In this study, we assume that $w(t)$ is unknown but bounded. However, the effect of $w(t)$ will deteriorate the control performance of control system. Therefore, how to eliminate the effect of $w(t)$ to guarantee the control performance is an important issue in the control systems. Since H_∞ control is the most important control design to efficiently eliminate the effect of $w(t)$ on the control system, it will be employed to deal with the robust performance control.

A. Physical model of the PMSM

By considering the classical simplifying assumptions, the dynamic model of the Permanent Magnet Synchronous Machine, in the synchronously d-q reference frame [12], can be described as [13]:

$$\dot{x}(t) = f(x(t)) + g(x(t))u(t) + w(t) \tag{4}$$

With :

$$\begin{aligned} x(t) &= \begin{bmatrix} I_d & I_q & w_r \end{bmatrix}^T, u(t) = \begin{bmatrix} vd & vq \end{bmatrix}^T \\ f(x(t)) &= \begin{bmatrix} -\frac{R_s}{L_d} I_d + \frac{L_q}{L_d} w_r I_q \\ -\frac{R_s}{L_q} I_q - \frac{L_d}{L_q} w_r I_d - \frac{\Phi}{L_q} w_r \\ \frac{p^2 \Phi}{J} I_q - \frac{f_c}{J} w_r \end{bmatrix} \\ g(x(t)) &= \begin{bmatrix} \frac{1}{L_d} & 0 & 0 \\ 0 & \frac{1}{L_q} & 0 \end{bmatrix}^T w(t) = \begin{bmatrix} 0 & 0 & -\frac{p}{J} c_r \end{bmatrix}^T \end{aligned}$$

Where w_r is the rotor speed, (I_d, I_q) are the d-q axis stator currents (vd, vq) are the d-q axis stator voltages. The load torque c_r is a known step disturbance. The motor parameters are the moment of inertia of the rotor J , the stator winding resistance R_s , the d-q axis inductances (L_d, L_q) , the friction coefficient f_c relating to the rotor speed, the flux linkage of the permanent magnets Φ and the number of poles pairs p .

B. T-S fuzzy model of the PMSM

The concept of flux oriented control is used to define a decoupled model of the PMSM, its principle is similar to the field oriented control for an induction motor.

Note that for synchronous machines there is no need for a flow model. Consequently, the rotor position is the angle of reference. Moreover, as we have a smooth poles machine, the best choice for its operation is obtained for a value where the internal angle of the machine is equal to $\frac{\pi}{2}$ that is to say

$$I_d = 0.$$

Then the nonlinear model of the PMSM can be written as the state space form:

$$\begin{cases} \dot{x}(t) = Ax(t) + Bu(t) + Dw(t) \\ y = Cx(t) \end{cases} \tag{5}$$

where :

$$A = \begin{bmatrix} -\frac{R_s}{L_d} & \frac{L_q}{L_d} w_r & 0 \\ -\frac{L_d}{L_q} w_r & -\frac{R_s}{L_q} & -\frac{\Phi}{L_q} \\ 0 & \frac{p^2 \Phi}{J} & -\frac{f_c}{J} \end{bmatrix}, B = \begin{bmatrix} \frac{1}{L_d} & 0 \\ 0 & \frac{1}{L_q} \\ 0 & 0 \end{bmatrix}$$

$$C = \begin{bmatrix} 1 & 0 & 0 \\ 0 & 1 & 0 \\ 0 & 0 & 1 \end{bmatrix} \text{ and } D = \begin{bmatrix} 0 \\ 0 \\ -\frac{p}{J} \end{bmatrix}$$

To transform the nonlinear model of the machine into a fuzzy linear Takagi-Sugeno model, the adopted method is to use a transformation on functions of one variable [9], [24], as follows:

Lemma: for $x \in [-a \ b]$, $a > 0$, $b > 0$ consider $f(x)$, $R \rightarrow R$, a bounded function, then there are always two functions $F_{i1}(x)$, $R \rightarrow R$, and $F_{i2}(x)$, $R \rightarrow R$ and two scalars α and β verifying the following properties:

$$F_{i1}(x) + F_{i2}(x) = 1, \quad F_{i1}(x) \geq 0, \quad F_{i2}(x) \geq 0 \text{ and}$$

$$f(x) = \alpha F_{i1}(x) + \beta F_{i2}(x)$$

Proof of Lemma: Considering that $f_{\min} \leq f(x) \leq f_{\max}$ we can always write:

$$f(x) = \alpha F_{i1}(x) + \beta F_{i2}(x)$$

With :

$$F_{i1}(x) = \frac{f(x) - f_{\min}}{f_{\max} - f_{\min}}, \quad F_{i2}(x) = 1 - F_{i1}(x)$$

$$f_{\max} = \alpha, \quad f_{\min} = \beta.$$

By applying this decomposition to the PMSM, we obtained local models defined by equation (1). The model state (5) of the machine has three variables, their products with the state variable vector generates the nonlinearity of the model machine. In our study, we have a linearity, resulting from the product of w_r with d-q axis currents. Thus the vector of premise variables may be defined by:

$$z(t) = z_1(t) = w_r(t) \tag{6}$$

With :

$$w_{r\min}(t) < w_r(t) < w_{r\max}(t)$$

From lemma 1, we can write :

$$z(t) = F_{11}z_{1\max}(t) + F_{12}z_{1\min}(t) \tag{7}$$

$$\begin{cases} F_{11} = \frac{z(t) - z_{1\min}(t)}{z_{1\max}(t) - z_{1\min}(t)} \\ F_{12} = \frac{z_{1\max}(t) - z(t)}{z_{1\max}(t) - z_{1\min}(t)} \end{cases} \tag{8}$$

III. SYNTHESIS OF CONTROL LAW

In the goal, to design a fuzzy linear state feedback controller, the so-called parallel distributed compensation

(PDC) is proposed. This concept uses a fuzzy linear controller for each sub-model. Then, the regulator thus produced shares the same basic rules as those of the fuzzy T-S model. The linear control rule i is derived based on the state equation (1) in the consequent part of the i th model rule.

Control Rule i

if ($z_1(t)$ is F_{i1}) and ($z_2(t)$ is F_{i2}) ..and ($z_p(t)$ is F_{ip})

$$\text{then } u(t) = K_i x(t) \quad i = 1, 2, \dots, r \tag{9}$$

where K_i is the local feedback gain matrix.

The final control u is inferred using the Sum-Product reasoning method:

$$u(t) = \sum_{i=1}^r h_i(z(t)) K_i x(t) \tag{10}$$

By substituting (10) in (3), the state equation of the error: $e(t) = x(t) - x_c$:

$$\begin{aligned} \dot{e}(t) = & \sum_{i=1}^r \sum_{j=1}^r h_i(z(t)) h_j(z(t)) [G_{ij} e(t) + \bar{D}_i \bar{w}(t)] \\ & + 2 \sum_{i < j}^r h_i(z(t)) h_j(z(t)) G_{ij} e(t) \end{aligned} \tag{11}$$

Where

$$G_{ij} = \frac{A_i + B_i K_j + A_j + B_j K_i}{2}$$

$$G_{ii} = A_i + B_i K_i$$

x_c : the reference

$$\bar{D} = \begin{bmatrix} A & D \end{bmatrix}; \quad \bar{w} = \begin{bmatrix} x_c \\ w \end{bmatrix}$$

Consider the H_∞ norm of the transfer function ($T_{e\bar{w}}$) between the error and the disturbance:

$$\|T_{e\bar{w}}\|_\infty = \sup_{\|\bar{w}(t)\|_{L_2}} \frac{\|e(t)\|_{L_2}}{\|\bar{w}(t)\|_{L_2}} \tag{12}$$

Where

$$\|e(t)\|_{L_2}^2 = \int_0^\infty e^T(t) e(t) dt, \text{ we can state the following lemma:}$$

Lemma: Consider the system defined by the equation (11). The H_∞ norm of the transfer function $T_{e\bar{w}}$ is inferior to γ if and only if there exist a symmetric defined matrix $Q > 0$ and Y such as the following inequalities are satisfied:

$$\begin{pmatrix} \text{sym} \{A_i Q + B_i Y_i\} & \bar{D} & Q C^T \\ * & -\gamma I & 0 \\ * & * & -\gamma I \end{pmatrix} < 0 \tag{13.a}$$

$$\begin{bmatrix} M_{11} & \bar{D} & QC^T \\ * & -\gamma I & 0 \\ * & * & -\gamma I \end{bmatrix} < 0 \quad (13.b)$$

with:

$$M_{11} = \text{sym}\{A_i Q + B_i Y_i\} + \text{sym}\{A_j Q + B_j Y_j\}$$

Proof of lemma: The H_∞ norm of the transfer function $T_{e\bar{w}}$ is inferior to γ if there exist a quadratic Lyapunov function $V(e) = e^T P e$ such as the Hamiltonian is negative:

$$\dot{V}(e) + e^T C^T C e - \gamma^2 \bar{w}^T \bar{w} < 0 \quad (14)$$

Thus owing to (11), inequality (14) can be written in the following form:

$$\begin{bmatrix} e^T \\ \bar{w}^T \end{bmatrix} \begin{bmatrix} \text{sym}\{PG_{ii}\} + C^T C & P\bar{D}_i \\ * & -\gamma^2 I \end{bmatrix} \begin{bmatrix} e \\ \bar{w} \end{bmatrix} < 0$$

$$\begin{bmatrix} e^T \\ \bar{w}^T \end{bmatrix} \begin{bmatrix} \text{sym}\{PG_{jj}\} + C^T C & P\bar{D}_i \\ * & -\gamma^2 I \end{bmatrix} \begin{bmatrix} e \\ \bar{w} \end{bmatrix} < 0 \quad \forall e, \bar{w}$$

Thus

$$\begin{bmatrix} \text{sym}\{PG_{ii}\} + C^T C & P\bar{D}_i \\ * & -\gamma^2 I \end{bmatrix} < 0$$

$$\begin{bmatrix} \text{sym}\{PG_{jj}\} + C^T C & P\bar{D}_i \\ * & -\gamma^2 I \end{bmatrix} < 0$$

Or equivalently

$$\begin{bmatrix} \text{sym}\{PG_{ii}\} & P\bar{D}_i \\ * & -\gamma^2 I \end{bmatrix} + \begin{bmatrix} C^T \\ 0 \end{bmatrix} I \begin{bmatrix} C & 0 \end{bmatrix} < 0$$

$$\begin{bmatrix} \text{sym}\{PG_{jj}\} + C^T C & P\bar{D}_i \\ * & -\gamma^2 I \end{bmatrix} + \begin{bmatrix} C^T \\ 0 \end{bmatrix} I \begin{bmatrix} C & 0 \end{bmatrix} < 0$$

Further if we set $Q^{-1} = \gamma^{-1} P > 0$ and using Shur complement then multiply on the right and the left by $\text{diag}(Q, I, I)$, we get the equation (13).

The fuzzy controller gain K_i is given by the following relation:

$$K_i = Q^{-1} Y_i \quad (15)$$

The matrices Q and Y_i verifying (13) have been computed.

$$Q = \begin{bmatrix} 0.0091 & -0.0000 & 0.0000 \\ -0.0000 & 0.0092 & 0.0119 \\ 0.0000 & 0.0119 & 0.4655 \end{bmatrix} \quad (16)$$

$$Y_1 = 10^3 \begin{bmatrix} -4.8854 & -0.3185 & 0.0086 \\ 0.2760 & -4.3620 & 0.0003 \end{bmatrix} \quad (17)$$

$$Y_2 = 10^3 \begin{bmatrix} -4.8855 & 0.3178 & -0.0083 \\ -0.2764 & -4.3620 & 0.0003 \end{bmatrix} \quad (18)$$

The obtained state feedback controllers are:

$$K_1 = \begin{bmatrix} -44.4298 & -2.8269 & 0.2042 \\ 2.5118 & -40.1178 & -51.5752 \end{bmatrix} \quad (19)$$

$$K_2 = \begin{bmatrix} -44.4301 & 2.8265 & -0.1053 \\ -2.5122 & -40.1178 & -51.5728 \end{bmatrix} \quad (20)$$

IV. SIMULATION AND EXPERIMENTAL RESULTS

In this section, the performance of the control scheme will be verified by numerical simulations and experiments in order to verify the effectiveness of our proposed fuzzy controller. The PMSM is driven by a PC-based Dspace 1104 controller card. The overall system consists of two permanent magnet synchronous machines fitted by a 1024 pulse/revolution incremental encoder and powered by a voltage inverter; one was used as a motor and the other as a load. The three-phase 1Kw PMSM is characterized by the following parameters:

Moment of inertia..... $J = 2.08 \cdot 10^{-3} \text{ Kg.m}^2$

Stator resistance..... $R_s = 0.56 \Omega$

Friction coefficient..... $f_c = 3.9 \cdot 10^{-3} \text{ Nm.s.rad}^{-1}$

d-axis inductance..... $L_d = 4.5 \text{ mH}$

q-axis inductance $L_q = 4.5 \text{ mH}$

Magnet flux constant..... $\Phi = 0.064 \text{ wb}$

Pole pair number..... $p = 2$

The proposed control algorithm was executed by the software Matlab / SIMULINK, and then compiled and implemented on Dspace 1104 controller card. The digital sampling period was taken equal to 0.1ms.

The fuzzy control law has been implemented on Dspace card DS1104 with a TMS320F240 processor. This card of control is composed of two processors. The master processor permits to manage the application while the slave processor generates the pulse width modulation (PWM) signals of control. It constitutes the «hardware» part of the Dspace card. The software used in the experiment laboratory is first based on MATLAB/Simulink program which permits an easy programming of the application real time under Simulink environment by the use of specific blocks included in the Real Time Interface (RTI) toolbox. The second program, Control Desk, permits to transfer the code of the Simulink program on the card, to create a control graphic interface of the process in real-time and to observe the evolution of the measured data. A set of I/O modules are constructed in the card « Connector panel CP1104 » for the voltage/current measurement, encoder

interface and the protection of the power inverter. The switching frequency of PWM for the IGBT chopper is 5kHz. In order to verify the effectiveness of the designed controller, a series of measurements has been accomplished.

Figures (1) to (7) illustrates the dynamic behaviour of the PMSM for enslavement speed vacuum.

The results show that the closed-loop system with the synthesized fuzzy controller has a good department: indeed, the measured speed and dq-axis currents track well the trajectory of reference one with good reliability over the whole speed range. Furthermore, the dq-axis currents responses are satisfying. From the results we can conclude the performance of the proposed control scheme.

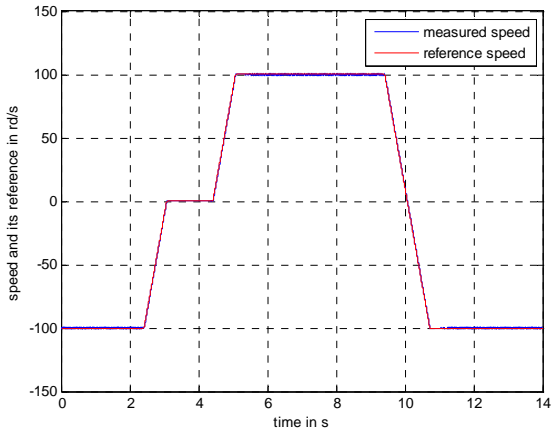

Fig. 3: speed and its reference

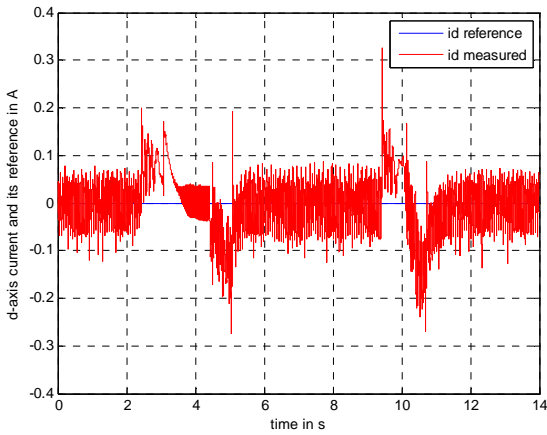

Fig. 1: d-axis current and its reference

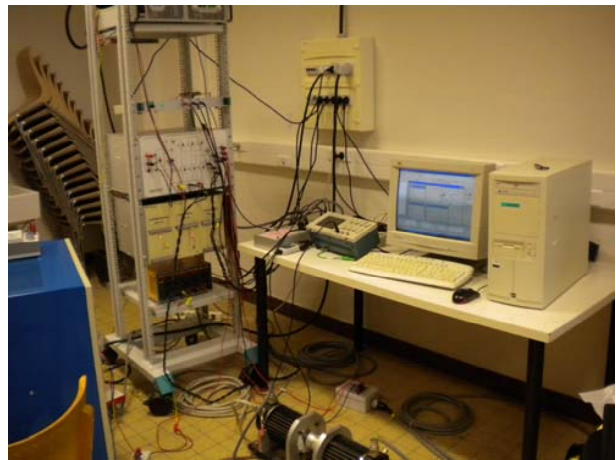

Fig. 4: Photo of the test bench

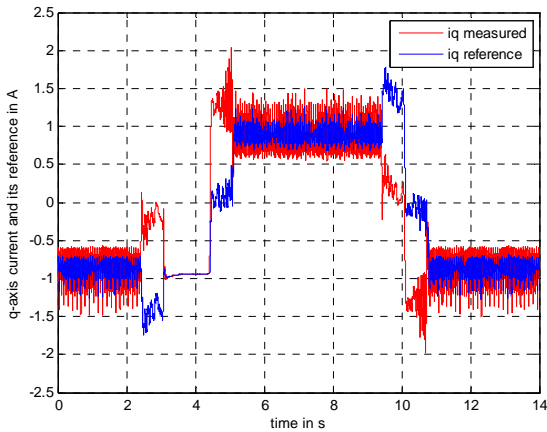

Fig. 2: q-axis current and its reference

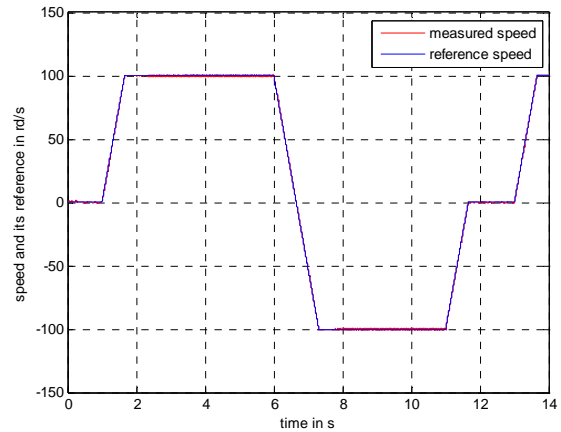

Fig. 5: speed and its reference

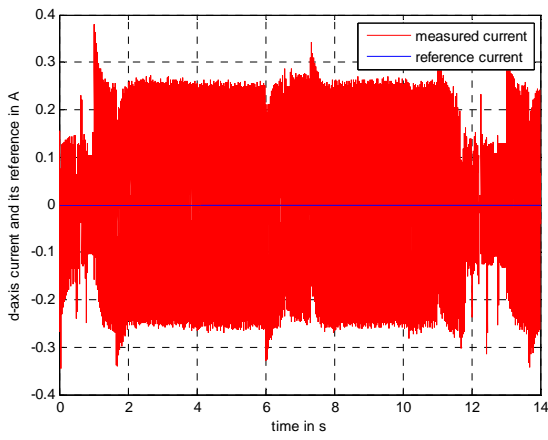

Fig. 6: d-axis current and its reference

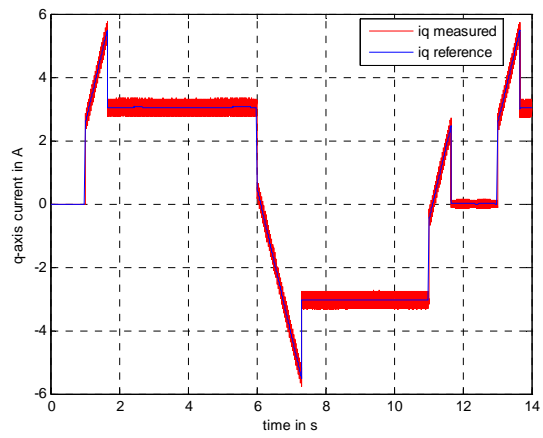

Fig. 7: q-axis current and its reference

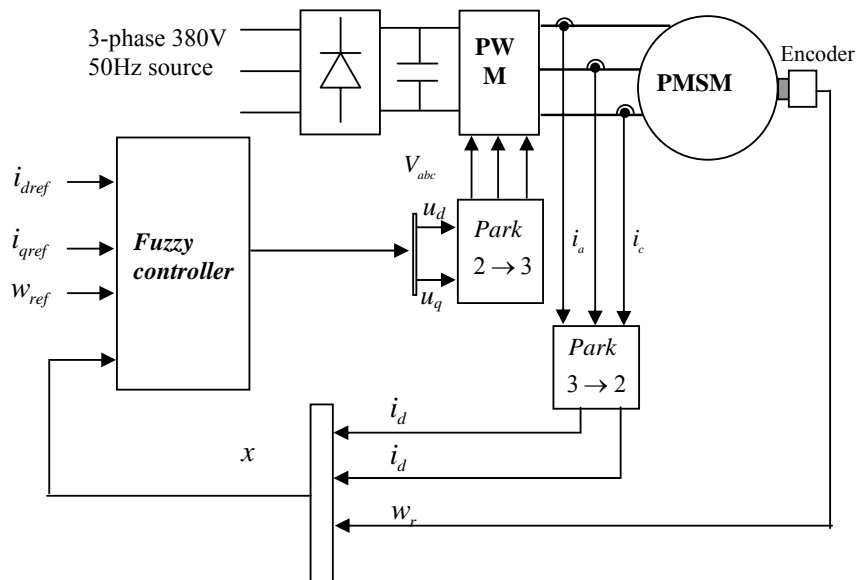

Fig. 8: Fuzzy control structure of PMSM

V. CONCLUSION

This paper develops a methodology to design a combined fuzzy state feedback controller and a H_∞ attenuation technique to achieve robust performance for nonlinear systems. The proposed robust fuzzy controller can be applied to any robust control design of the nonlinear system. With the aid of linear fuzzy approximation algorithm and LMI technique, the robust H_∞ control design can be extended from exactly known linear systems toward nonlinear systems. By employing the H_∞ attenuation technique, the performance of linear fuzzy control design for the nonlinear systems can be significantly improved. Furthermore, the robust fuzzy control scheme is also developed to eliminate as possible the effect of external disturbance. The proposed design method is simple, and the number of membership functions for the proposed control law can be extremely small. However, because of the use of fuzzy approximation technique and H_∞ control scheme, the results are less conservative than the other robust control methods. The controller developed has been implemented with success on a permanent magnet synchronous machine (PMSM).

ACKNOWLEDGMENT

This work was supported by the Mixed Committee for the Academic Cooperation "CMCU" project and Research Unit of Industrial Processes Control "UCPI" in the National Engineering School of Sfax, Tunisia.

The authors wish to thank all the team of the Laboratory of Automatic and Industrial Informatics of the University of Poitiers FRANCE and special thanks to Pr. Gerard Champenois for the aid he afforded us for the realization of our experimental work validation.

REFERENCES

- [1] D. Driankov, H. Hellendoorn and M. Reinfrank, "An introduction to fuzzy control", Springer, Berlin Heidelberg, 1993.
- [2] T. M. Guerra and S. Ouattara, "Overview of the evolution of concepts and applications of fuzzy control", first congress AFCET, pp 1-10, 1993.
- [3] C. C. Lee, "Fuzzy logic in control systems", Fuzzy logic controller. part I IEEE Transactions on systems, Man and Cybernetics, 20, pp 419-435, 1990.
- [4] C. Melin and B. Vidolov, "Stabilisation of linear systems by fuzzy controllers", part I. RAIRO-APII.JESA, volume 30, Issue 5 :pp 675-705, French 1996.
- [5] H. B. Verbruggen, H. J. Zimmermann, and R. Babuska, "Fuzzy algorithm for control", Chapter I. International series in Intelligent Technologies., KAP, 1999.
- [6] K. Tanaka, T. Ikeda and H. O. Wang, "fuzzy regulators and fuzzy observers: Relaxed stability conditions and LMI-based design", IEEE Transactions on fuzzy systems, Volume 6, Issue 2, pp. 1-16, 1998.
- [7] Li C. Raymond, S. Boverie and A. Titli, "Fuzzy multivariable control design from the fuzzy system model", proceeding Sixth IFSA, World Congress, Sao Paulo, Brasil, 1995.
- [8] X. J. Ma, Z. Q. Sun and Y. Y. He, "Analysis and design of fuzzy controller and fuzzy observer", IEEE Transactions on fuzzy systems, volume 6, Issue 1, pp 41-50, 1998.
- [9] Y. Morere, "Implementation of control laws for T-S fuzzy models", Doctoral thesis, University of Valencia and Hainant Combresis, 1999.
- [10] M. Chaabane and M. Souissi, "Robust stability and stabilization of systems: Application to an agricultural greenhouse", Fifth automatic Tunisian seminar STA'2004, pp. 26-52, Hammamet, Tunisia 2004.
- [11] M. Souissi, "Modeling and Control of an agricultural greenhouse", Thesis statement in physical sciences, Faculty of science of Tunis FST, 2002.
- [12] B. K. Bose, "Power electronics and AC driv". New york, Prince Hall, first Edition, chapter 2, pp.95, 1986.
- [13] S. Hassaine, "Application of new techniques for controlling the synchronous machine permanent magnet, Ph.D. USTO University. Oran, Algeria, 2008.
- [14] G. Feng, S. G. Cao, N. W. Rees, M. Cheng and J. Ma, "H ∞ control of continuous time fuzzy dynamic systems, IEEE, Fuzzy'97, Barcelona.
- [15] S. G. Cao, N. W. Rees and G. Feng, "Further results about quadratic stability of continuous time fuzzy control systems, Int. J.Systems Science, vol 28, N $^{\circ}$ 4 pp 397-404, 1997.
- [16] S. G. Cao, N. W. Rees and G. Feng, "Quadratic stability analysis and design of continuous time fuzzy control systems", Int. J.Systems Science, vol 27, pp 193-203, 1996.
- [17] Z. X. Hang, G. Feng and T. H. Lee, "Stability analysis and design of fuzzy control systems using LMI techniques", Proc.Control 97, Sydney, Australia.
- [18] S. G. Cao, N. W. Rees, G. Feng, "H-infinity control of nonlinear continuous time systems based on dynamical fuzzy models, Int. J.Systems Sci.27 pp 821-830, 1996.
- [19] B. S. Chen, C. S. Tseng, H. J. Uang, "Robustness design of nonlinear dynamic systems via fuzzy control", IEEE Trans. Fuzzy Systems, vol 7, pp 571-585, 1999.
- [20] B. S. Chen, C. S. Tseng, H. J. Uang, "Mixed H $_2$ /H ∞ Fuzzy output feedback control design for nonlinear dynamic systems: An LMI approach", IEEE Trans. Fuzzy Systems vol 8, pp 249-265, 2000.
- [21] T. M. Guerra, L. Vermeiren, "Control law for Takagi-Sugeno fuzzy models", Fuzzy Sets and Systems Vol. 120, pp 95-108, 2001.
- [22] X.Liu, Q.Zhang, "New approach to controller designs based on fuzzy observers for T-S systems via LMI. Automatica vol 39, pp 1571-1582, 2003.
- [23] K. S., Narendra and A. M. Annaswamy, "Stable Adaptive Systems". Englewood Cliffs, NJ: Prentice-Hall 1989.
- [24] K. Tanaka, T. Ikeda and H. O. Wang, "Fuzzy regulators and fuzzy observers: Relaxed stability conditions and LMI-based design", IEEE Transaction on Fuzzy Systems, Vol. 6, N $^{\circ}$ 1, pp 1-16, 1998.
- [25] G. O. Young, "Synthetic structure of industrial plastics (Book style with paper title and editor)," in *Plastics*, 2nd ed. vol. 3, J. Peters, Ed. New York: McGraw-Hill, 1964, pp. 15-64.

Jamel Khedri was born in Sfax, Tunisia, on March 3, 1978. He received the Master degree from National School of Engineers of Sfax (ENIS), University of Sfax, Tunisia, in 2005. His current research interests are robust control, fuzzy logic control, D-stability analysis and applications of these techniques to induction motors.

Mohamed Chaabane was born in Sfax, Tunisia, on 1961. He received the Ph. D degree in Electrical Engineering from the University of Nancy, French in 1991. He was associate professor at the University of Nancy and is a researcher at Center of Automatic Control of Nancy (CRAN) from 1988-1992. Actually is a professor in ENI-Sfax. Since 1997, he is holding a search position at Automatic Control Unit, ENIS. The main research interests are in the field of robust control, delay systems, descriptor systems and applications of these techniques to fed-batch processes and agriculture systems. Currently, he is an associate editor of International Journal on Sciences and Techniques of Automatic control computer engineering, IJ-STA (www.sta-tn.com).

Mansour SOUSSI was born in Kerkennah, Tunisia, on 1955. He received his Ph. D in Physical Sciences from the University of Tunisian 2002. He is Professor in Automatic Control at Preparatory Institute of Engineers of Sfax, Tunisia. Since 2003, he is holding a search position at Automatic Control Unit, National School of Engineers of Sfax, Tunisia. His current research interests are robust control, optimal control, fuzzy logic, linear matrix inequalities and applications of these techniques to agriculture systems. Pr Souissi is a member of the organization committees of several national and international conferences (STA, CASA, etc.).

Driss MEHDI is currently a Professor at Institute of Technology of Poitiers, France. He is the headmaster of the research group "Multivariable Systems and Robust Control" in Laboratory of Automatic and Industrial Informatics of Poitiers. His main fields of research include robust control, delay systems, robust root-clustering, descriptor systems, control of industrial processes, etc.