

Study of Tower Grounding Resistance Effected Back Flashover to 500 kV Transmission Line in Thailand by using ATP/EMTP

B. Marungsri, S. Boonpoke, A. Rawangpai, A. Oonsivilai, and C. Kritayakornupong

Abstract—This study describes analysis of tower grounding resistance effected the back flashover voltage across insulator string in a transmission system. This paper studies the 500 kV transmission lines from Mae Moh, Lampang to Nong Chok, Bangkok, Thailand, which is double circuit in the same steel tower with two overhead ground wires. The factor of this study includes magnitude of lightning stroke, and front time of lightning stroke. Steel tower uses multistory tower model. The assumption of studies based on the return stroke current ranged 1-200 kA, front time of lightning stroke between 1 μ s to 3 μ s. The simulations study the effect of varying tower grounding resistance that affect the lightning current. Simulation results are analyzed lightning over voltage that causes back flashover at insulator strings. This study helps to know causes of problems of back flashover the transmission line system, and also be as a guideline solving the problem for 500 kV transmission line systems, as well.

Keywords—Tower grounding resistance, back flashover, multistory tower model, lightning stroke current.

I. INTRODUCTION

THAILAND is tropical country which having a lot of thunderstorm days and lightning discharge activities in one year. The back bone of power system transmission is overhead transmission system. So, it is essential to investigate a lightning surge for a reliable operation of a power system, because the lightning surge over voltage is one of dominant factors for the insulation design of the power system and the protection of equipments in power transmissions and substations. When lightning strikes the top of a transmission tower, a lightning current flows down to the bottom of the tower and causes a tower voltage rise which results in a back-flashover across an insulator string.

At present, Electric Generation Authority of Thailand (EGAT) has expanded to total about 2,600 circuits-km of 500 kV, as shown in Fig. 1[1]. Switching over voltage in EGAT system has been conducted by some researchers [1-5]. However, the lightning over voltage estimation of overall

system which may occur and reach the lightning withstand voltage has not yet been conducted. EGAT requires analyzing the voltage level of lightning over voltage of existing 500 kV transmission lines.

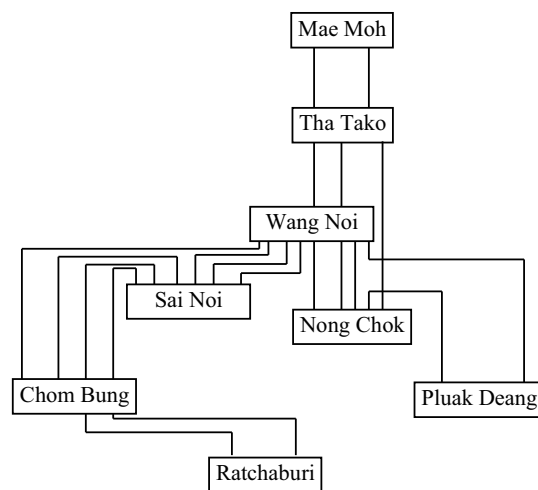

Fig. 1 Existing EGAT 500 kV Transmission System

EGAT have been reported the statistic of lightning occurs in northern region during March-August 2005[6]. The report concluded that the lightning often occurs during April to May. But the most severe lightning takes place in June. The positive lightning is about 5% with magnitude between 11 kA and 171 kA. But the negative lightning is about 95% with magnitude between -10 kA to -139 kA. The most lightning magnitude is between -10 kA and -50 kA.

When lightning stroke strikes the top of a tower, a traveling voltage is generated which travels back and forth along the tower, being reflected at the tower grounding and at the tower top, thus raising the voltage at the cross-arms and stressing the insulator strings. Flashover will occur across an insulator string if this lightning transient voltage exceeds its lightning withstand voltage level. Such flashover called back flashover. Back flashover voltages are generated by multiple reflections along the struck tower and also along the shield wire for shield lines at the adjacent towers. The lightning induced over voltage across an insulator string for the struck tower is not a

B. Marungsri is with Suranaree University of Technology, Nakhon Ratchasima, 30000, Thailand (phone: +66 4422 4366; fax: +66 4422 4601; e-mail: bmshvee@ sut.ac.th).

S. Boonpoke, A. Rawangpai and A. Oonsivilai are with Suranaree University of Technology, Nakhon Ratchasima, 30000, Thailand.

C. Kritayakornupong is with Electricity Generating Authority of Thailand (EGAT).

straightforward. The peak of lightning induced voltage will be directly proportional to the peak of lightning stroke current.

This paper is organized as follows. Models of system studied are provided in Section II. Then, the simulation results with various factors are discussed in section III. Finally, conclusion is presented in Section IV.

II. PARAMETERS AND MODEL OF EGAT 500 KV TRANSMISSION LINE

A. Structures of 500 kV Transmission Lines

Tower structure configuration type DQV9(9°) is used in this study. Tower dimensions are illustrated in Fig. 2. The full details of 500 kV transmission line tower are as follows:

Conductor: 4 Bundle per phase (795 MCM 54/7 ACSR)

Spacing between = 45.7 cm

Diameter = 2.773 cm

DC resistance = 0.07094 ohm/km

Ruling span = 420 m

Ultimate strength = 12,800 kg

Weight = 1.52 kg/m Wind span = 500 m

Shield wire: 3/8" EHS, Class A, Galvanized steel

Number of wires = 2 per tower

Shielding angle = -5° to outer phases

Ultimate strength = 6985 kg

Diameter = 9.1444 mm

Weight = 0.406 kg/m

Insulator: Type Suspension, ball and socket

ANSI Class 52-8 and ANSI Class 52-11

Based on max. conductor tension of 22% rated

Tensile strength with wind pressure of 86 kg/m²

Grounding system: ground resistance 10 ohms or less

A. Stub angle to rebar : used in all cases

B. Ground rods : used in all cases, one ground rod at

each tower leg

Lightning outage rate: Less than 0.05 per 100 km per year

Right-of-way width: 70 meters for each line

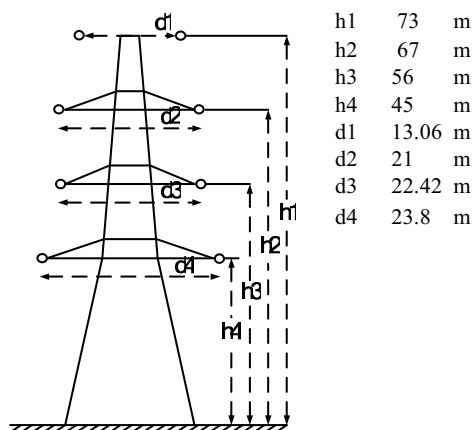

Fig. 2 Tower Configuration

B. Lightning Source Model

It is well known that the magnitude of impulse current due to a lightning discharge is a probability function. Low discharge levels of lightning current between 5 to 22 kA may result in a higher tendency for the lightning strike to pass by any shield wires and directly hit a phase conductor. While, the larger magnitude of lightning impulse currents may tend to strike the tower top or overhead ground wire and lead to a back flashover across the insulator string[7]. Front time and tail time of lightning waveform and lightning current amplitudes in this study are given in TABLE I. Lightning current from lightning stroke is modeled as an impulse current source parallel with the impedance of a lightning path as shown in Fig. 3. The resistance value is taken to be 400 Ω, which was derived by Bewley [8].

TABLE I LIGHTNING AMPLITUDES AND WAVEFORMS

Lightning Current Amplitude	Waveform t_F / t_T
- 34 kA	1 / 30.2 μs
- 50 kA	1.2 / 50 μs
- 100 kA	2 / 77.5 μs
- 139 kA	3 / 75 μs

C. Tower and Transmission Line Model

The double circuit with two overhead ground wire transmission tower is considered in this study is shown in Fig. 1. The tower is modeled as a transmission line for surge propagation. The surge impedance of the tower and the propagation velocity down the tower are estimated and applied in a multistory tower model [9 – 11]. Each parts of tower are represented by distributed parameter model, with lossless high frequency approximation. The main surge propagation path is modeled with frequency dependent transmission lines even if the length is only a few meters. The tower model is shown in Fig. 4. Multistory tower model parameters are shown in TABLE II. Simulation of span between tower uses frequency dependent (phase) model. The span of towers 7 spans is simulated, as shown in Fig. 3, and the parameters of transmission line used in this study is shown in Fig. 2.

D. Tower Grounding Resistance Model

The tower grounding resistance for fast transient surges is not well understood. The impulse grounding resistance or high frequency grounding resistance is less than the measured at low frequency or calculated resistance because significant ground currents cause voltage gradients sufficient to breakdown the soil around the ground rod. A variable grounding resistance approximation can be applied which is surge current dependent as in (1) [7].

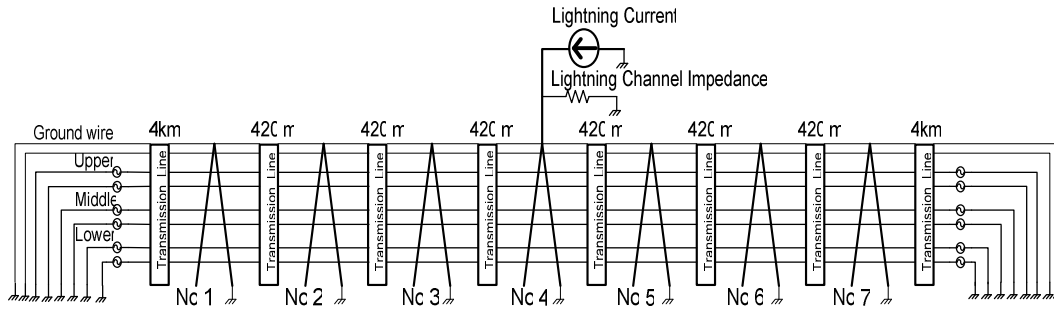

Fig. 3 Span of 7 Towers in This Study

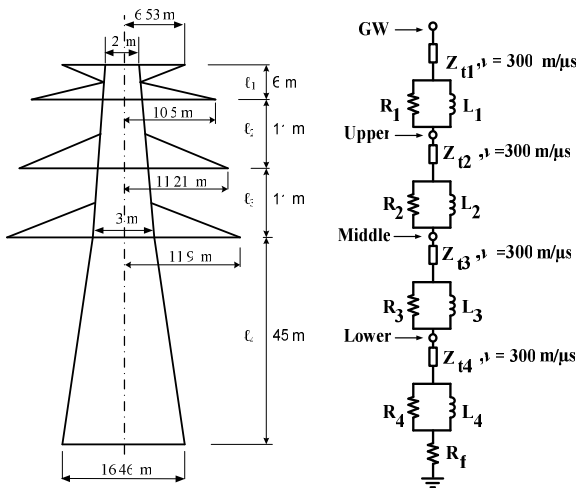

Fig. 4 Multistory Tower Model

TABLE II
MULTISTORY MODEL PARAMETERS

$Z_{t1} = Z_{t2} = Z_{t3} = 200 \Omega$, $Z_{t4} = 150 \Omega$	
$\tau = 2H/v \mu s$ $\gamma = 0.8944$	
$r_1 = -2 \times Z_{t1} \times \ln \gamma / (l_1 + l_2 + l_3) \Omega/m$	
$r_2 = -2 \times Z_{t2} \times \ln \gamma / (l_4) \Omega/m$	
$R_1 = r_1 \times l_1 = 10.52 \Omega$	$R_2 = r_1 \times l_2 = 19.29 \Omega$
$R_3 = r_1 \times l_3 = 19.29 \Omega$	$R_4 = r_2 \times l_4 = 33.48 \Omega$
$L_1 = R_1 \times \tau = 5.12 \mu H$	$L_2 = R_2 \times \tau = 9.39 \mu H$
$L_3 = R_3 \times \tau = 9.39 \mu H$	$L_4 = R_4 \times \tau = 16.29 \mu H$
$R_f = 5-100 \Omega$	

$$R_f = \frac{R_g}{\sqrt{1 + \frac{I}{I_g}}} \quad (1)$$

where R_f is tower grounding resistance (ohm),
 R_g is tower grounding resistance at low current and low frequency (ohm),
 I is surge current into ground (kA),
 I_g is limiting current initiating soil ionization (kA).

$$I_g = \frac{1}{2\pi} \left(\frac{E_0 \rho_0}{R_g^2} \right) \quad (2)$$

where ρ_0 is soil resistivity (ohm-meter),
 E_0 is soil ionization gradient (about 300 kV/m).

E. Back Flashover Model

It is well-known that back flashover occurring when tower potential is higher than lightning impulse withstand voltage or BIL level of the insulator strings. Lightning impulse withstand voltage level of the insulator string is not a unique number. The insulator string may withstand a high magnitude impulse voltage which has a short duration even it has failed to withstand a lower magnitude impulse voltage with longer duration. This characteristic of the insulator string is known as the volt-time characteristic or V-t curve. A simplified expression of withstand voltage capability for an insulator string can be calculated as in (3) [7].

$$V_{f0} = K_1 + \frac{K_2}{t^{0.75}} \quad (3)$$

where V_{f0} is a flashover voltage (kV),

K_1 is $400 * L$,

K_2 is $710 * L$,

L is insulator length, (m),

t is elapsed time after lightning stroke, μs .

In this study $L = 4.429$ m, lightning impulse withstand voltage of the insulators insulator string can be represented by volt-time curve as shown in Fig. 5. If the voltage across the insulator string exceeds its impulse voltage withstand capability, the back flashover occurs.

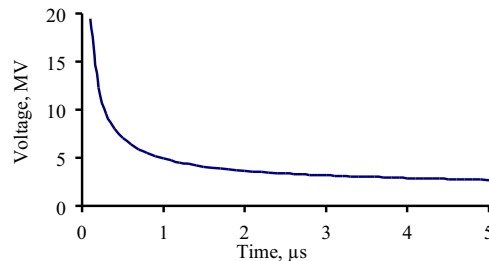

Fig. 5 V-t Curve of the Insulator String

III. SIMULATION RESULTS

In this section, the 500 kV transmission line as shown in Fig. 3 has been modeled using ATP/EMTP. The tower grounding resistance is one of factors effected the back flashover voltage across the insulator string in transmission system as mention earlier. In this paper, only tower grounding resistance will be considered with various factors that affected back flashover. The factors of this study include front time of lightning stroke, and magnitude of lightning stroke.

A. Front Time of Lightning Stroke Current

A lightning flash generally consists of several strokes which are lower charges, negative or positive, from the cloud to the ground. The first stroke is most often more severe than the subsequent strokes [7]. As shown in Fig. 5, impulse voltage withstand capability of the insulator string depends on front time of lightning strokes. In order to elucidate the effect of front time of lightning stroke current, lightning stroke current – 34 kA having different wave front and wave tail times, i.e. 1/30.2 μ s, 1.2/50 μ s, 2/77.5 μ s and 3/75 μ s is used to simulate lightning induced voltage across the insulator strings at upper, middle and lower phases[12]. Simulation results are illustrated in Fig. 6. In spite of the same magnitude of lightning stroke current and same tower grounding resistance, obviously differences in the magnitude of impulse voltage across the insulator strings can be seen when comparing each phase having different wave shape.

B. Magnitude of Lightning Stroke

Due to negative lightning stroke current in Thailand having magnitude between -10 kA to -139 kA and the most lightning stroke current having magnitude between -10 kA and -50 kA, three different magnitudes of lightning stroke current, i. e. -50 kA, -100 kA and -139 kA are used to simulate the effect of lightning stroke current. Fig. 7– Fig. 9 illustrated the maximum amplitude of lightning induced voltage across phase insulator strings. Obviously, the effect of front time on tower induced voltage can be seen on the simulation results. From (3) and time at maximum value of tower induced voltage, back flashovers across phase insulator strings due to lightning stroke current are summarized in TABLE III – TABLE VI. No back flashover occurs in case of lightning stroke current -50 kA although tower grounding resistant vary from 5 – 100 Ω . In case of -100 kA, almost back flashovers occur on the top phase insulator string especially fast front time of lightning stroke. However, more back flashovers also occur on the other phase insulator strings in case of slow front time of lightning stroke. In case of -139 kA, back flashover occurs on all phase insulator string.

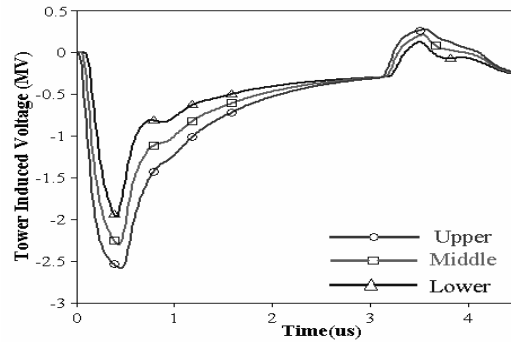

(a) Lightning Stroke Current Waveform 1.0/30.2 μ s

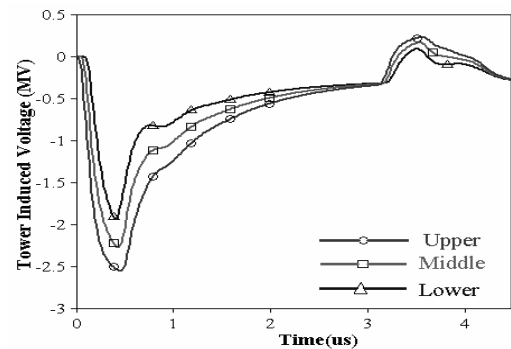

(b) Lightning Stroke Current Waveform 1.2/50 μ s

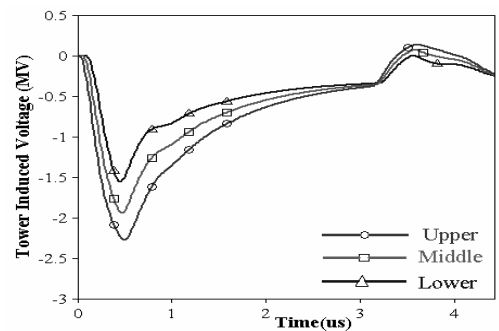

(c) Lightning Stroke Current Waveform 2.0/77.5 μ s

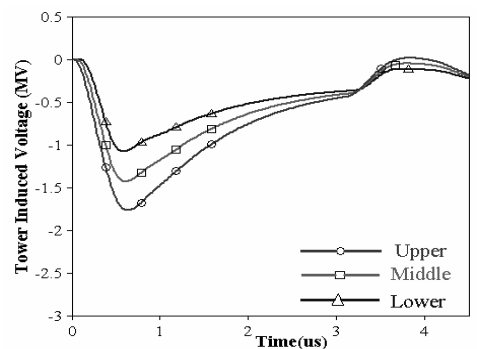

(d) Lightning Stroke Current Waveform 3.0/75 μ s

Fig.6 Impulse Voltage Waveform across Phase Insulator String in case of Lightning Stroke Current – 34 kA

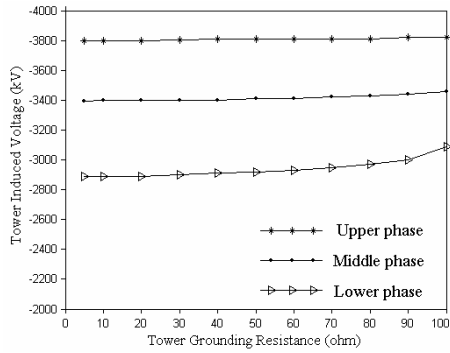

(a) Waveform 1.0/30.2 μ s

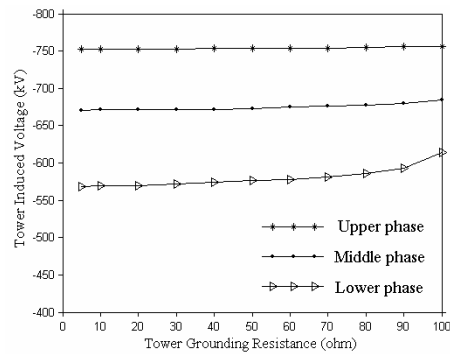

(b) Waveform 1.2/50 μ s

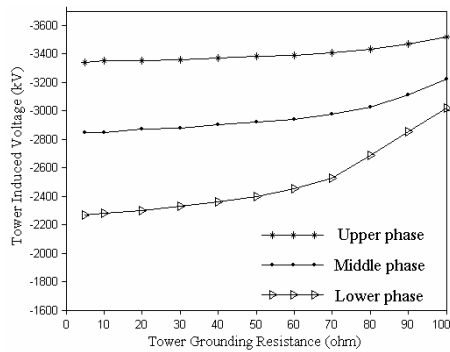

(c) Waveform 2.0/77.5 μ s

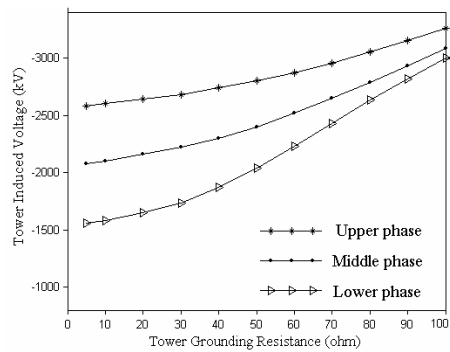

(d) Waveform 3.0/75 μ s

Fig.7 Maximum Value of Tower Induced Voltage across Phase Insulator Strings in case of Lightning Stroke Current -50 kA

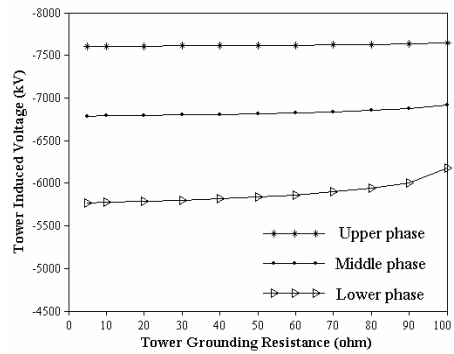

(a) Waveform 1.0/30.2 μ s

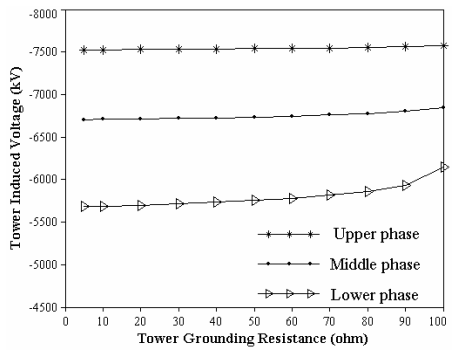

(b) Waveform 1.2/50 μ s

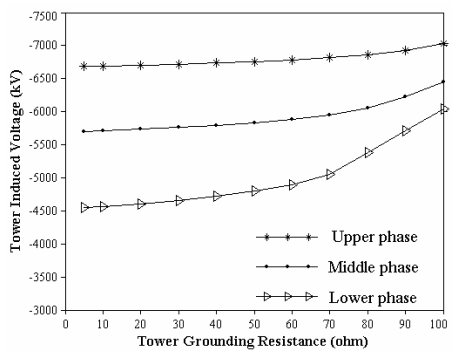

(c) Waveform 2.0/77.5 μ s

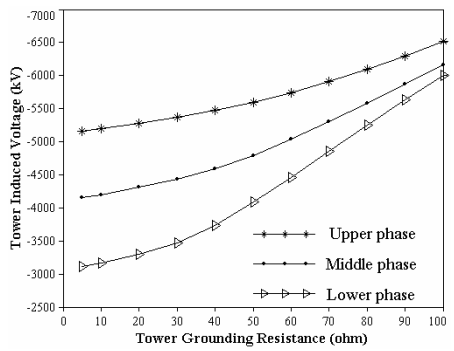

(d) Waveform 3.0/75 μ s

Fig. 8 Maximum Value of Tower Induced Voltage across Phase Insulator Strings in case of Lightning Stroke Current -100 kA

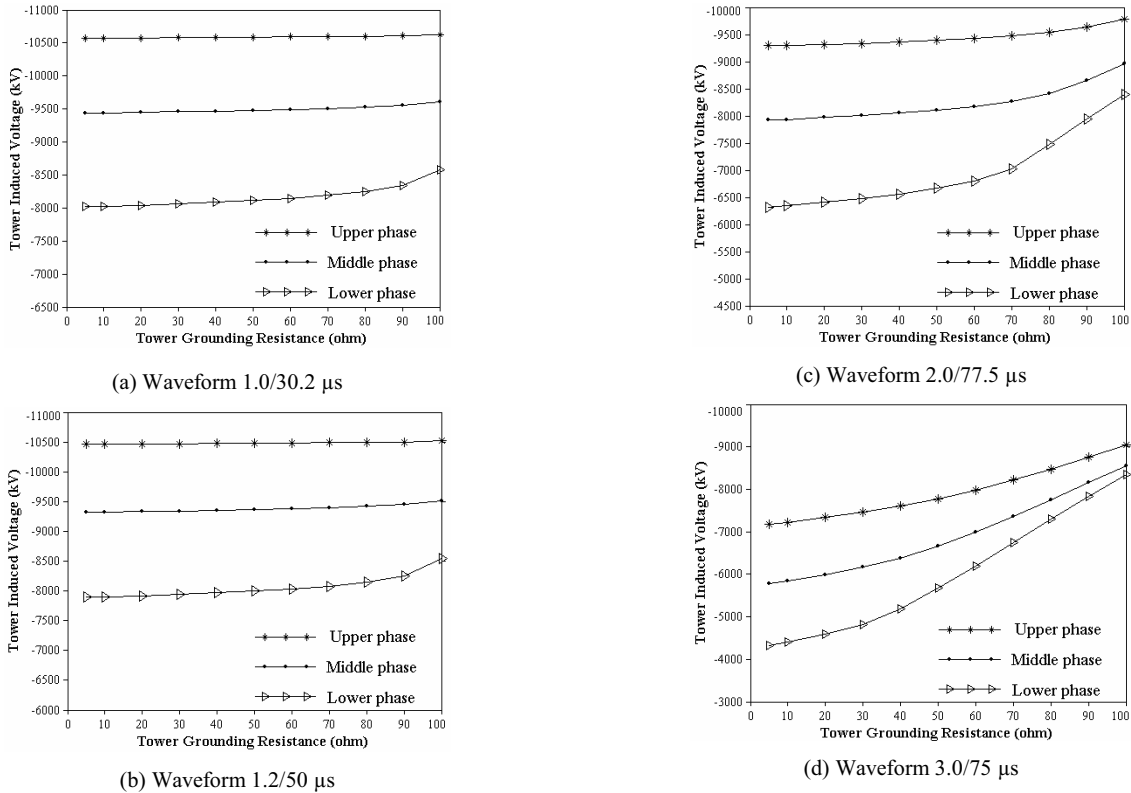

Fig. 9 Maximum Value of Tower Induced Voltage across Phase Insulator Strings in case of Lightning Stroke Current -139 kA

TABLE III
BACK FLASHOVER ACROSS PHASE INSULATOR STRINGS IN CASE OF WAVEFORM 1/30.2 μ s

Tower grounding resistance (ohm)	-50 kA			-100kA			-139 kA		
	Upper (MV)	Middle (MV)	Lower (MV)	Upper (MV)	Middle (MV)	Lower (MV)	Upper (MV)	Middle (MV)	Lower (MV)
5	X	X	X	O	X	X	O	O	X
10	X	X	X	O	X	X	O	O	O
20	X	X	X	O	X	X	O	O	O
30	X	X	X	O	X	X	O	O	O
40	X	X	X	O	X	X	O	O	O
50	X	X	X	O	X	X	O	O	O
60	X	X	X	O	X	X	O	O	O
70	X	X	X	O	X	X	O	O	O
80	X	X	X	O	X	X	O	O	O
90	X	X	X	O	X	X	O	O	O
100	X	X	X	O	X	O	O	O	O

O : flashover X: no flashover

TABLE IV
BACK FLASHOVER ACROSS PHASE INSULATOR STRINGS IN CASE OF WAVEFORM 1.2/50 μ s

Tower grounding resistance (ohm)	-50 kA			-100 kA			-139 kA		
	Upper	Middle	Lower	Upper	Middle	Lower	Upper	Middle	Lower
5	X	X	X	O	X	X	O	O	X
10	X	X	X	O	X	X	O	O	X
20	X	X	X	O	X	X	O	O	X
30	X	X	X	O	X	X	O	O	O
40	X	X	X	O	X	X	O	O	O
50	X	X	X	O	X	X	O	O	O
60	X	X	X	O	X	X	O	O	O
70	X	X	X	O	X	X	O	O	O
80	X	X	X	O	X	X	O	O	O
90	X	X	X	O	X	X	O	O	O
100	X	X	X	O	X	O	O	O	O

O : flashover X: no flashover

TABLE V
BACK FLASHOVER ACROSS PHASE INSULATOR STRINGS IN CASE OF WAVEFORM 2/77.5 μ S

Tower grounding resistance (ohm)	-50 kA			-100 kA			-139 kA		
	Upper (MV)	Middle (MV)	Lower (MV)	Upper (MV)	Middle (MV)	Lower (MV)	Upper (MV)	Middle (MV)	Lower (MV)
5	X	X	X	X	X	X	O	O	X
10	X	X	X	X	X	X	O	O	X
20	X	X	X	X	X	X	O	O	X
30	X	X	X	X	X	X	O	O	X
40	X	X	X	X	X	X	O	O	X
50	X	X	X	X	X	X	O	O	X
60	X	X	X	X	X	X	O	O	X
70	X	X	X	O	X	X	O	O	O
80	X	X	X	O	X	O	O	O	O
90	X	X	X	O	O	O	O	O	O
100	X	X	X	O	O	O	O	O	O

O: flashover X: no flashover

TABLE VI
BACK FLASHOVER ACROSS PHASE INSULATOR STRINGS IN CASE OF WAVEFORM 3/75 μ S

Tower grounding resistance (ohm)	-50 kA			-100 kA			-139 kA		
	Upper (MV)	Middle (MV)	Lower (MV)	Upper (MV)	Middle (MV)	Lower (MV)	Upper (MV)	Middle (MV)	Lower (MV)
5	X	X	X	X	X	X	O	X	X
10	X	X	X	X	X	X	O	X	X
20	X	X	X	X	X	X	O	X	X
30	X	X	X	X	X	X	O	O	X
40	X	X	X	X	X	X	O	O	O
50	X	X	X	O	X	X	O	O	O
60	X	X	X	O	O	O	O	O	O
70	X	X	X	O	O	O	O	O	O
80	X	X	X	O	O	O	O	O	O
90	X	X	X	O	O	O	O	O	O
100	X	X	X	O	O	O	O	O	O

O: flashover X: no flashover

IV. CONCLUSION

This paper has described an analysis of Tower grounding resistance effected the back flashover voltage across phase insulator string in EGAT 500 kV transmission system. As seen from simulation results, the shorter front time of lightning stroke current will increase the lightning induced over voltage across phase insulator string. No back flashover occurs in case of the most lightning stroke current having magnitude between -10 kA and -50 kA. When the magnitude of lightning stroke current is up to -100kA, the back flashover always occurs with any tower footing resistances. The simulation results have shown that the higher tower grounding resistance has potential to damage the transmission line by back flashover across the phase insulator strings. However, it still has other factors and counterpoint measures to consider reducing the back flashover for transmission line.

REFERENCES

- [1] K. Ngamsanroj and W. Tayati, "An Analysis Of Switching Overvoltages in the EGAT 500 kV Transmission System", Large Engineering Systems Conference on Power Engineering, 7-9 May 2003, pp. 149 – 153.
- [2] C. Y. Yu, N. Petcharakas and C. Panprommin, "The Statistical Calculation of Energization Overvoltages, Case of EGAT 500 kV Lines", IEEE Power Engineering Society Winter Meeting , Vol. 4, 23-27 Jan. 2000, pp. 2705 - 2709.
- [3] C. Jaipraditham, " Electromagnetic Field Analysis on Surge Response of 500 kV EHV Single Circuit Transmission Tower in Lightning Protection System using Neural Networks", Proc. of Int. Conf. on Control, Automation and System, KINTEX, Gyeonggi-Do, Korea, 2-5 June 2005.
- [4] N. Petcharakas, C. Y. Yu and C. Panprommin, " A Study of Ferranti and Energization Overvoltages case of 500 kV Line in Thailand", 11th Int. Sym. on High Voltage Engineering, Vol. 1, Conf. Publ. No. 467, 1999, pp. 291-294.
- [5] P. Yadee and S. Premrudeepreechacham, "Analysis of Tower Footing Resistance Effected Back Flashover Across Insulator in a Transmission System", Proc. of Int. Conf. on Power Systems Transients (IPST'07) , Lyon, France, June 4-7, 2007.
- [6] Report of flashover voltage in Northern Region Operation Division 1996-2003, EGAT, Thailand. (in Thai)
- [7] A. R. Hileman, *Insulation Coordination for Power Systems*, Marcel Dekker, New York, USA, 1989.
- [8] L. V. Bewley, *Traveling Waves on Transmission Systems*. Dover Publications, New York, N.Y., USA, 1951.
- [9] M. Ishii, T. Kawamura, T. Kouno, E. Ohsaki, K. Shiokawa, K. Murotani and T. Higuchi, "Multistory Transmission Tower Model for Lightning Surge Analysis", *IEEE Trans. on Power Delivery*, Vol. 6, No. 3, July 1991, pp. 1327 – 1335.
- [10] T. Yamada, A. Mochizuki, J. Sawada, E. Zaima, T. Kawamura, A. Ametani, M. Ishii and S. Kato, "Experimental evaluation of a UHV tower model for lightning surge analysis", *IEEE Trans. on Power Delivery*, Vol. 10, No. 1, January 1995, pp. 393 – 402.
- [11] A. Ametani, N. Nagaoka, T. Funabashi and N. Inoue, "Tower Structure Effect on a Back-Flashover Phase", Proc. of Int. Conf. on Power Systems Transients (IPST'05), Paper No. IPST05 – 190, Montreal, Canada, June 19-23, 2005.

- [12] R. B. Anderson and A. J. Erikson, "Lightning Parameters for Engineering Applications", *ELECTRA* 69, March 1980, pp. 65 – 102.



Boonruang Marungsri was born in Nakhon Ratchasima Province, Thailand, in 1973. He received his B. Eng. and M. Eng. from Chulalongkorn University, Thailand in 1996 and 1999 and D. Eng. from Chubu University, Kasugai, Aichi, Japan in 2006, all in electrical engineering, respectively. Dr. Marungsri is currently a lecturer in School of Electrical Engineering, Suranaree

University of Technology, Thailand. His areas of interest are electrical power system and high voltage insulation technologies.



Suphachai Boonpoke was born in Surin Province, Thailand, in 1984. He received his B. Eng. in Electrical Engineering from Suranaree University of Technology, Nakhon Ratchasima, Thailand, in 2005. Recently, he is a graduate student in School of Electrical Engineering, Suranaree University of Technology. His research interesting area is high voltage insulation technology.



Anucha Rawangpai was born in Ratchaburee Province, Thailand, in 1985. He received his B. Eng. in Electrical Engineering from Suranaree University of Technology, Nakhon Ratchasima, Thailand, in 2005. Recently, he is a graduate student in School of Electrical Engineering, Suranaree University of Technology. His research interesting area is high voltage insulation technology.



Anant Oonsivilai was born in Khon Kaen Province, Thailand, in 1963. He received his B. Eng. from Khon Kaen University, and M. Eng. from King Mongkut Institute of Technology North Bangkok, Thailand and PhD. from Dalhousie University, Canada, all in electrical Engineering, in 1986, 1992 and 2000, respectively. Dr. Oonsivilai is currently an Assistant Professor in School of Electrical Engineering, Suranaree

University of Technology, Thailand. His areas of interest are electrical power system, stability, control technology, advance alternative, and sustainable energy.



Chanin Kritayakornupong was born in Bangkok, Thailand, in 1974. He received his B.Eng and M.Eng both in electrical engineering from Chulalongkorn University, Bangkok, Thailand, in 1996 and 1998, respectively. In 1999, he joined Electricity Generating Authority of Thailand (EGAT). He is now an Engineer Level 6 of transmission line maintenance technology section, transmission line technology and aviation department, transmission system maintenance division.