

Numerical Simulation of Heat Exchanger Area of R410A-R23 and R404A-R508B Cascade Refrigeration System at Various Evaporating and Condensing Temperature

A. D. Parekh, P. R. Tailor

Abstract—Capacity and efficiency of any refrigerating system diminish rapidly as the difference between the evaporating and condensing temperature is increased by reduction in the evaporator temperature. The single stage vapour compression refrigeration system is limited to an evaporator temperature of -40°C . Below temperature of -40°C the either cascade refrigeration system or multi stage vapour compression system is employed. Present work describes thermal design of main three heat exchangers namely condenser (HTS), cascade condenser and evaporator (LTS) of R404A-R508B and R410A-R23 cascade refrigeration system. Heat transfer area of condenser (HTS), cascade condenser and evaporator (LTS) for both systems have been compared and the effect of condensing and evaporating temperature on heat-transfer area for both systems have been studied under same operating condition. The results shows that the required heat-transfer area of condenser and cascade condenser for R410A-R23 cascade system is lower than the R404A-R508B cascade system but heat transfer area of evaporator is similar for both the system. The heat transfer area of condenser and cascade condenser decreases with increase in condensing temperature (T_c), whereas the heat transfer area of cascade condenser and evaporator increases with increase in evaporating temperature (T_e).

Keywords—Heat-transfer area, R410A, R404A, R508B, R23, Refrigeration system, Thermal design

I. INTRODUCTION

VAPOUR compression cycle is widely used in industrial and residential applications, such as refrigeration system, air conditioning systems, oil refineries, petrochemicals etc. It has already been established that the capacity and efficiency of any refrigerating system diminish rapidly as the difference between the evaporating and condensing temperature is increased by a reduction in the evaporator temperature. The single stage vapour compression refrigeration system is limited to an evaporator temperature of -40°C . Below this temperature the cascade or multistage refrigeration system is used [1]. In order

to obtain the required performance of cascade refrigeration system it is necessary to design condenser, cascade condenser and evaporator, the main three heat exchanger of the cascade system. Thermal design requires information regarding the heat transfer between or through the material or any component. It also deals with the thermodynamic and thermo-physical properties of material or working fluid. The design method needs the mathematical modeling of components. P.Byrne et.al.[2] designed Heat Pump for simultaneous heating and cooling (HPS) in hotels, luxury dwellings and smaller office buildings. The ambient air is used as a balancing source to run a heating or a cooling mode. Author have built numerical models and run simulations with highly efficient compressors and heat exchangers models to evaluate the performance of an HPS and compared the results to those of a standard reversible heat pump. C.Apreaa et.al. [3] experimentally measured the mean heat transfer coefficients of R22 and R407C in the coaxial counter flow evaporator of a refrigerating vapour compression plant. The results illustrate that the R22 heat transfer coefficient is always greater than that of R407C. J R Khan et.al. [4] developed a finite-time thermodynamic model which simulates the working of an actual vapor-compression system. The model is used for predicting an optimum distribution of heat-exchanger areas between the evaporator and condenser for a given total heat exchanger area. In addition, the effect of subcooling and superheating on the system performance is also investigated. P.A. Domanski and David Yashar [5] presented experiments with a novel intelligent optimization module, ISHED (Intelligent System for Heat Exchanger Design), applied to maximize capacity through circuitry design of finned-tube condensers. The module seeks refrigerant circuitry designs that maximize the condenser capacity for specified operating conditions and condenser slab design constraints. Y.Liang et.al. [6] have described and analyzed a novel design of multiple parallel-pass (MPP) micro channel tube condenser and its applications to automotive A/C systems. Performance test results show MPP condenser is able to improve heat transfer rate as high as 9.5% while its refrigerant mass flow increases 13.34% when comparing to a benchmark Parallel flow condenser. M.M.Nasr and M.Salah Hassan [7] presented an innovative condenser for residential refrigerator. A vapour

A. D. Parekh, Sardhar Vallabhbhai National Institute of Technology, Surat-395007, Gujarat, India (e-mail: adp@med.svnit.ac.in).

P. R. Tailor, Sardhar Vallabhbhai National Institute of Technology, Surat-395007, Gujarat, India . (e-mail: prt@med.svnit.ac.in).

compression cycle incorporating the proposed evaporative condenser was tested to evaluate the cycle performance. The thermal properties at the different points of the refrigeration cycle were measured for typical operating conditions.

In present work the thermal design of main three heat exchangers namely condenser (HTS), cascade condenser and evaporator (LTS) of R404A-R508B and R410A-R23 cascade refrigeration system has been carried out. The comparison has been made for heat transfer area of three heat exchangers for both the systems. The effect of condensing and evaporating temperature on heat-transfer area of condenser (HTS), cascade condenser and evaporator (LTS) have been studied for both the systems.

II. DESIGN METHODOLOGY FOR CASCADE REFRIGERATION SYSTEM

Fig. 1 shows the cascade refrigeration system in which low pressure and low temperature LTS refrigerant vapour in superheated form at state 5 enters into compressor where it compressed to high pressure and temperature at state 6. It is then condensed and sub-cooled in cascade condenser from state 6 to state 7 by transferring heat to HTS refrigerant. LTS refrigerant is further expanded in expansion device from state 7 to 8. HTS refrigerant in a superheated form at state 1 compressed to high pressure and high temperature vapour at state 2. It is further condensed and sub-cooled to state 3 in water cooled condenser. HTS refrigerant is further expanded in expansion device from state 3 to 4. It is then evaporated to state 1 in cascade condenser by extracting heat from LTS refrigerant. Design of cascade system has been carried out for evaporating temperature (T_e) of $-80\text{ }^\circ\text{C}$, condensing temperature (T_c) of $32\text{ }^\circ\text{C}$, cooling capacity of 0.5 kW, superheating and subcooling of $10\text{ }^\circ\text{C}$ for both HTS and LTS, compressor efficiency of 80% for HTS and 85% for LTS. In evaluation of heat-transfer coefficient for refrigerants fouling factor and wall resistance for tube wall are neglected. Condenser is water-cooled concentric tube type in which temperature rise of water is assumed 6 K. Inner and outer tube are made of copper material with outside diameter of 0.00635 m and 0.0127 m respectively. Air inside the cabinet is cooled by evaporator coil is made of copper material having outer diameter of 0.0095 m. In cascade condenser LTS refrigerant flowing through the inner tube of diameter 0.00635 m and is surrounded by HTS refrigerant flowing through outer tube of diameter 0.0127 m. Thermal conductivity of copper tube is taken 386 W/m K.

III. GOVERNING EQUATIONS

The enthalpy and entropy of the refrigerant after compression process is given by equation,

$$h = h'_{sat} + C_p (T_{sup} - T'_{sat}) \quad (1)$$

$$s = s'_{sat} + C_p \ln \frac{T_{sup}}{T'_{sat}} \quad (2)$$

The compressor efficiency for both HTS and LTS compressor is defined as

$$\eta_{comp} = \frac{\Delta h_{act}}{\Delta h_{isen}} \quad (3)$$

The velocity of refrigerant flowing through the tube of condenser & evaporator is found using continuity equation

$$u = \frac{\dot{m}}{\rho A} \quad (4)$$

Reynolds number of flow through the tube,

$$Re = \frac{\rho u D}{\mu} \quad (5)$$

The overall heat-transfer coefficient for condenser and evaporator is defined by following correlation [8]

$$\frac{1}{UA_0} = \frac{1}{h_i A_i} + \frac{1}{h_o A_o} + \frac{\ln(D_o/D_i)}{2\pi k L} + F_i + F_o \quad (6)$$

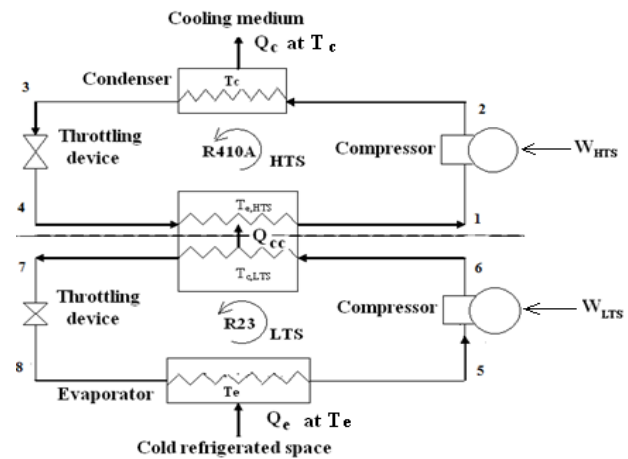

Fig. 1 Schematic diagram of cascade refrigeration system

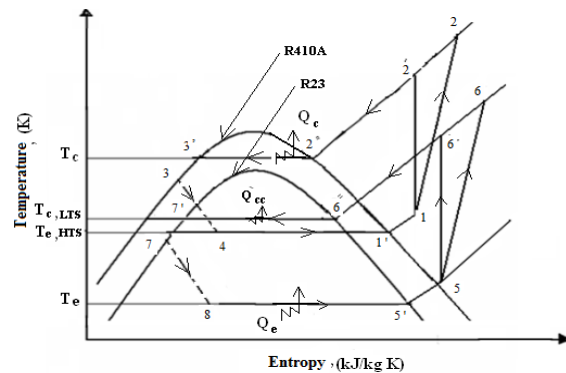

Fig. 2 Temperature-entropy diagram of cascade refrigeration system

The heat transfer through the condenser and evaporator is correlated by following equation [8]

$$Q = UA_s (LMTD) \tag{7}$$

The log mean temperature difference for fluids flowing through the condenser and evaporator is correlated by [8]

$$LMTD = \frac{(T_{hot,i} - T_{cold,o}) - (T_{hot,o} - T_{cold,i})}{\ln \left[\frac{(T_{hot,i} - T_{cold,o})}{(T_{hot,o} - T_{cold,i})} \right]} \tag{8}$$

The heat-transfer coefficient for working fluid (refrigerant) side in HTS condenser is defined by following correlation [9]

$$h_i = 0.55 \left[\frac{g \rho_f (\rho_f - \rho_g) k_f^3 h'_{fg}}{\mu_f \Delta T d} \right]^{0.25} \tag{9}$$

Where, $h'_{fg} = h_{fg} + \frac{3}{8} C_f \Delta T_i =$ modified latent heat in kJ/kg. The heat-transfer coefficient for working fluid (refrigerant) side in LTS evaporator is defined by following correlation [10]-[11]

$$h_i \Delta t = \mu_f h_{fg} \left[\frac{g(\rho_f - \rho_g)}{\sigma} \right]^{0.5} \left[\frac{C_{pf} \Delta t}{h_{fg} C_{sf} pr^{1.7}} \right] \tag{10}$$

The heat-transfer coefficient for secondary fluid (water) flowing through the tube of heat exchanger is correlated by following equation [12]

$$\frac{h_{water} D_{e,water}}{k_{water}} = 0.023 \times (Re)^{0.8} \times (pr)^{0.4} \tag{11}$$

Where, $D_{equivalent} = \frac{4A_f}{p}$

The heat-transfer coefficient for secondary fluid (air) flowing through the tube of heat exchanger is correlated by following equation [13]

$$\frac{h_{air} D_{e,air}}{k_{air}} = 0.266 \times (Re)^{0.805} \times (pr)^{1/3} \tag{12}$$

IV. RESULTS AND DISCUSSION

Computational model has been developed in engineering equation solver [14] to find the heat transfer area of condenser (HTS), cascade condenser and evaporator (LTS) at different condensing and evaporating temperature. Table I and table II shows the required heat transfer area of condenser (HTS), cascade condenser and evaporator (LTS) for R404A-R508B and R410A-R23 cascade system respectively. Results show that highest heat transfer area is required for the condenser for both systems as the heat load of condenser is high. The heat transfer area required for R404A-R508B cascade system is

higher than R410A-R23 cascade system for all three heat exchangers.

TABLE I THERMAL DESIGN FOR R410A-R23 CASCADE SYSTEM

R410A-R23 Cascade refrigeration system	$T_c = 32\text{ }^\circ\text{C}, T_e = -80\text{ }^\circ\text{C}, DT = 2\text{ }^\circ\text{C}$		
	Heat transfer area (m ²)	Required length of heat exchanger (m)	Heat duty (kW)
Condenser (HTS)	0.4127	21.89	1.361
Cascade condenser	0.2015	10.69	0.7276
Evaporator (LTS)	0.0933	3.121	0.5

TABLE II THERMAL DESIGN FOR R404A-R508B CASCADE SYSTEM

R404A-R508B Cascade refrigeration system	$T_c = 32\text{ }^\circ\text{C}, T_e = -80\text{ }^\circ\text{C}, DT = 2\text{ }^\circ\text{C}$		
	Heat transfer area (m ²)	Required length of heat exchanger (m)	Heat duty (kW)
Condenser (HTS)	0.6836	36.28	1.352
Cascade condenser	0.276	14.64	0.7371
Evaporator (LTS)	0.1037	3.467	0.5

From Fig. 3 it can be seen that when condensing temperature has been increased from 35 °C to 43 °C the required heat transfer area of condenser (HTS) decreased parabolically for R404A-R508B cascade system while for R410A-R23 cascade system it decreased linearly. The required heat transfer area of R404A-R508B system is higher than the R410A-R23 system until the condenser temperature of 41.5 °C. But after condenser temperature of 41.5 °C heat transfer area required for R410A-R23 system is higher than R404A-R508B system.

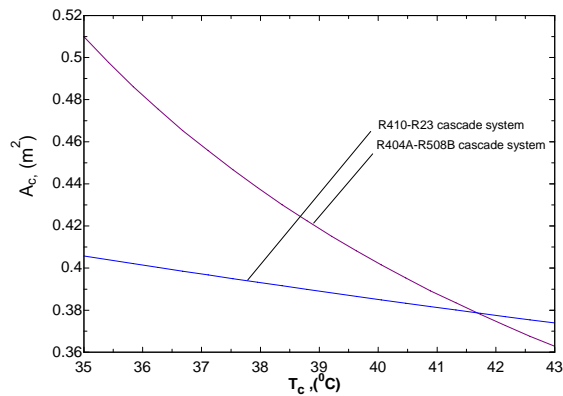

Fig. 3 Effect of condenser temperature (HTS) on condenser heat transfer area

Fig. 4 shows that there is no effect of condensing temperature on evaporator heat transfer area for both the cascade systems. But practically change in thermodynamic properties of refrigerant at one place affect the properties of

refrigerant at subsequent state. So practically there is effect of condensing temperature on evaporator heat transfer area.

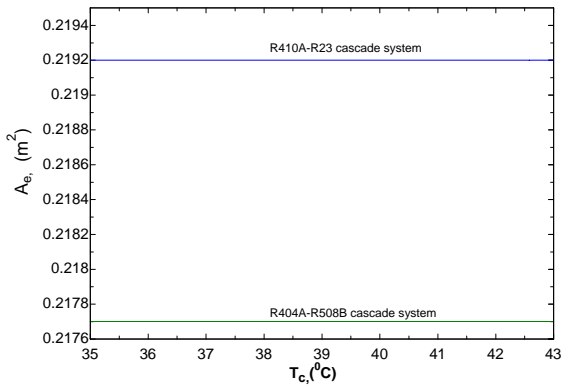

Fig. 4 Effect of condenser temperature (HTS) on evaporator heat transfer area

Fig. 5 shows that as condensing temperature increases the heat transfer area of cascade condenser decreases linearly. Heat transfer area of R404A-R508B system decreased by 7.56 % and area of R410A-R23 system decreased by 6.49 % when condensing temperature has been increased from 35 °C to 43 °C. Fig. 6 shows that when evaporating temperature has increased from -85 °C to -75 °C the condenser heat transfer area of R404A-R508B system decreased by 7.55 % and of R410A-R23 system decreased by 7.86 %.

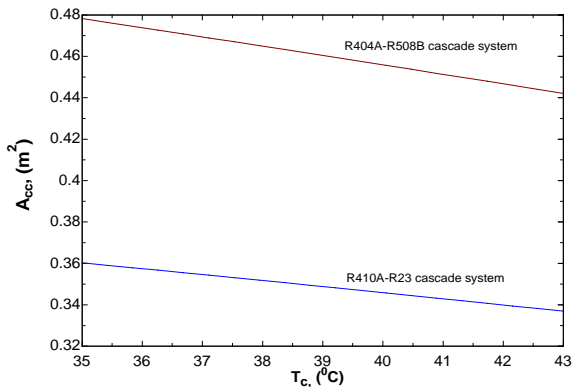

Fig. 5 Effect of condenser temperature (HTS) on cascade condenser heat transfer area

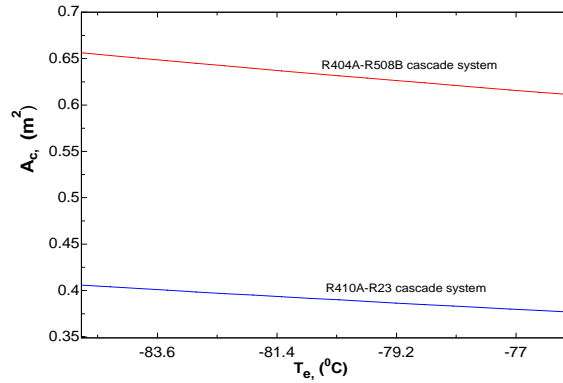

Fig. 6 Effect of evaporator temperature (LTS) on condenser heat transfer area

From fig. 7 it can be seen as evaporator temperature increases cascade condenser heat transfer area increases linearly. Heat transfer area of R404A-R508B system increased by 13.61 % and area of R410A-R23 system increased by 18.50 % when evaporator temperature has been increased from -85 °C to -75 °C.

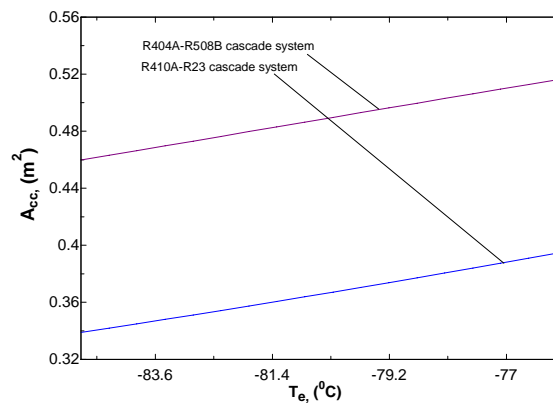

Fig. 7 Effect of evaporator temperature (LTS) on cascade condenser heat transfer area

Fig. 8 shows that the evaporator heat transfer area increases parabolically when evaporator temperature has been increased from -85 °C to -75 °C for both systems and there is marginal difference in heat transfer area for both systems at all evaporator temperature.

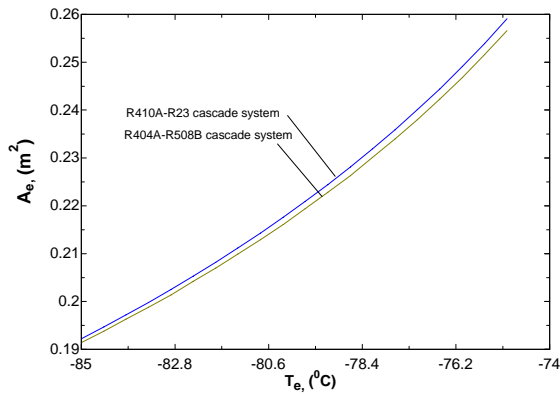

Fig. 8 Effect of evaporator temperature (LTS) on evaporator heat transfer area

V. CONCLUSIONS

In present work thermal design of condenser (HTS), cascade condenser and evaporator (LTS) of cascade refrigeration system has been carried out using two HFC refrigerant pairs R404A-R508B and R410A-R23. The required heat transfer area of condenser (HTS), cascade condenser and evaporator (LTS) is compared for both systems under same operating conditions. The effect of condensing temperature and evaporating temperature on heat-transfer area of above three heat exchangers of cascade refrigeration system has been studied for a set condition. The R410A-R23 cascade refrigeration system requires less heat-transfer area for condenser (HTS), cascade condenser and evaporator (LTS) compared to R404A-R508B cascade refrigeration system. The system having low heat transfer area means economically cheaper, less in weight and occupies less space.

NOMENCLATURE

A, A _s	area, m ²
COP	coefficient of performance
C	specific heat of fluid, kJ/kg-K
C _{sf}	boiling coefficient
D	diameter of condenser and evaporator tube, m
F	Fouling factor
h	Enthalpy, kJ/kg
k	thermal conductivity, W/m-K
LMTD	log-mean temperature difference, °C
L	length of condenser and evaporator tube, m
m	mass flow-rate of refrigerant, kg/s
Nu	Nusselt number
Pr	Prandtl number
Q	total heat transfer, kW
RE	refrigeration effect, kW
Re	Reynolds number
u	velocity of refrigerant, m/s
U	overall heat-transfer coefficient, W/m ² -K
W _{total}	total Compressor work, kW

Subscript

act	actual
Comp	compressor
c	condenser
e	evaporator
f	fluid
g	gas
HTS	high temperature stage
isen	isentropic
i	inside
LTS	low temperature stage
o	outside
sf	secondary fluid
s	surface
sat	saturated
sup	superheated
w	water

Greek Symbol

ρ	density of refrigerant, kg/m ³
η _{comp}	compressor efficiency
σ	surface tension, N/m
μ	dynamic viscosity of refrigerant, N-s/m ²

REFERENCES

- [1] Roy J.Dossat "principle of refrigeration." (1997) 444-445.
- [2] P.Byrne, J.Mirieli, Y. Lenat, Design and simulation of a heat pump for simultaneous heating and cooling using HFC or CO₂ as a working fluid, Int.J.Ref, 12, 2009, 1-13.
- [3] C.Apreaa, F Rossib, A. Grecoc, Experimental evaluation of R22 and R407C evaporative heat transfer coefficients in a vapour compression plant, Int.J.Ref, 23, 2000, 366-377.
- [4] J.R. Khan, S.M.Zubair, Design and performance evaluation of reciprocating refrigeration systems, Int.J.Ref, 22, 1999, 235-243.
- [5] Piotr A. Domanski and David Yashar, Optimization of finned-tube condensers using an intelligent system, Int.J. of Ref, 30,2007,482-488.
- [6] Y. Liang, M.W Tonga, X Zengc, Design and analysis of multiple parallel-pass condensers, Int.J.Ref, 32, 2009,1153- 1161.
- [7] M.M. Nasr, M. Salah Hassan, "Experimental and theoretical investigation of an innovative evaporative condenser for residential refrigerator." Renewable energy 34 (2009) 2447 -2454.
- [8] C P Arora, "Refrigeration and air-conditioning" by Tata Mcgraw hill (2005) 301-310.
- [9] Chato J C, AHREA J. Feb. (1962) 52.
- [10] Chawla J M, " correlations of convective heat transfer coefficient for two-phase liquid-vapour flow". Heat Transfer, proceeding of the international conference on Heat Transfer, paris Vol. V, (1970), paper B 5-7.
- [11] Rohsenow W M, "A method of correlating heat transfer data for surface boiling of liquids", Trans. ASME, Vol. 74, 1952.
- [12] Dittus F W and Boelter, LMK, Univ. Calif. (Berkeley) pub. Eng., Vol. 2 (1930), p. 443.
- [13] Grimson E D, "Correlation and utilization of new data on flow resistance and heat transfer for cross-flow of gasees over tube banks", Trans. ASME, Vol. 59, (1937), pp. 583-594.
- [14] S. A. Klien, Engineering Equation Solver, commercial V7.027.