

Effects of Opening Shape and Location on the Structural Strength of R.C. Deep Beams with Openings

Haider M. Alsaeq

Abstract—This research investigates the effects of the opening shape and location on the structural behavior of reinforced concrete deep beam with openings, while keeping the opening size unchanged. The software ANSYS 12.1 is used to handle the nonlinear finite element analysis. The ultimate strength of reinforced concrete deep beam with opening obtained by ANSYS 12.1 shows fair agreement with the experimental results, with a difference of no more than 20%. The present work concludes that the opening location has much more effect on the structural strength than the opening shape. It was concluded that placing the openings near the upper corners of the deep beam may double the strength, and the use of a rectangular narrow opening, with the long sides in the horizontal direction, can save up to 40% of structural strength of the deep beam.

Keywords—Deep Beams, Finite Element, Opening, Reinforced Concrete.

I. INTRODUCTION

THEACI 318-08 code specifies that deep beams “have either: (a) clear spans, l_n , equal to or less than four times the overall member depth; or (b) regions with concentrated loads within twice the member depth from the face of the support” [1].

Reinforced concrete deep beams are members in which a significant amount of the load is carried to the support by a compression thrust joining the loading and reaction point. Some references specify that deep beams should be loaded on loading points and supported on reaction points so that compression struts can develop between the loads and supports [11]. Reinforced concrete beams with openings have complex stress and had been investigated by many researchers in the last decade [2], [6], [9], [10].

In the present research, the opening size is fixed, while the opening shape and location are altered to obtain the optimal results.

Usually, there are two common methods of strengthening deep beams with circular or square openings, these methods are:

1. Internal strengthening using steel bars around the opening in different patterns and quantities.
2. External strengthening using CFRP laminates around the opening in different patterns and quantities.

Haider M. Alsaeq is Lecturer at the Civil Engineering Department, College of Engineering, University of Babylon. Phone: +9647807366707; e-mail: haidermufeed@yahoo.com.

The first method is suitable when the opening is planned before the construction and during the design stage, while the second procedure is beneficial when the opening is introduced after the construction, the case in which no analysis and design considerations were taken concerning the opening. The use of CFRP layers to strengthen reinforced concrete structures became very popular recently and has many advantages [2], [4], [7]. However, the present work investigates the opening optimum shape and location, rather than studying how to strengthen an opening with fixed shape and location.

II. FINITE ELEMENT MODELING

A. Concrete

The eight nodes element “CONCRET65” is used in the present research to model concrete material. The element is also called “SOLID65”. It is used for the 3-D modeling of solids with or without reinforcing bars (rebar). The element is capable of cracking in tension and crushing in compression. In concrete applications, for example, the solid capability of the element may be used to model the concrete while the rebar capability is available for modeling reinforcement behavior. Other cases for which the element is also applicable would be reinforced composites (such as fiberglass), and geological materials (such as rock). The element is defined by eight nodes having three degrees of freedom at each node: translations in the nodal x, y, and z directions, as shown in Fig. 1. Up to three different rebar specifications may be defined.

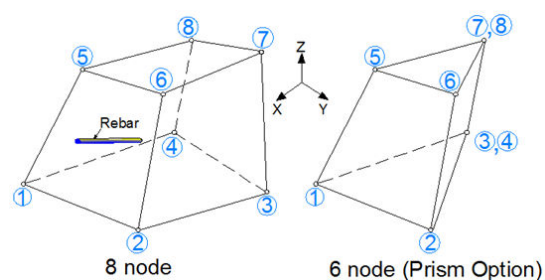

Fig. 1 Geometry of the element CONCRET65 [3]

This element has special cracking and crushing capabilities, and its most important aspect is the treatment of nonlinear material properties. The concrete is capable of cracking (in

three orthogonal directions), crushing, plastic deformation, and creep. The rebar are capable of tension and compression, but not shear. They are also capable of plastic deformation and creep [3]. However, the rebar capability of this element was not used in the present work, because the discrete reinforcement model is adopted, in which the reinforcing bars are modeled using the SPAR8 elements, and then merged with the concrete elements in the proper locations.

B. Steel Bars

The one dimensional two-node element “SPAR8” is used in the present work to model the rebar. This element is sometimes called “LINK8”, and is very popular. The element may be used in a variety of engineering applications. Besides steel bars in reinforced concrete structures, this element can be used to model trusses, sagging cables, links, springs, etc. The 3-D spar element is a uniaxial tension-compression element with three degrees of freedom at each node: translations in the nodal x, y, and z directions as illustrate in Fig. 2. As in a pin-jointed structure, no bending of the element is considered. Plasticity, creep, swelling, stress stiffening, and large deflection capabilities are included [3]. The nodes of this element are aligned with the nodes of the CONCRET65 elements to allow for merging the nodes together. Hence, a perfect bond between concrete and steel is automatically introduced.

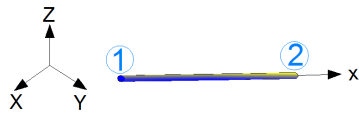

Fig. 2 Geometry of the element SPAR8 [3]

III. MATERIAL MODELING

A. Concrete

It is not an easy task to establish accurate stress-strain relationship for concrete. Concrete has crushing and cracking possibilities, and behaves differently in compression and tension. Fig. 3 shows the typical stress-strain curve for normal weight concrete [8].

In compression, the stress-strain curve for concrete is linearly elastic up to about 30 percent of the maximum compressive strength. Above this point, the stress increases gradually up to the maximum compressive strength. After it reaches the maximum compressive strength σ_{cu} , the curve descends into a softening region, and eventually crushing failure occurs at an ultimate strain ϵ_{cu} . In tension, the stress-strain curve for concrete is approximately linearly elastic up to the maximum tensile strength. After this point, the concrete cracks and the strength decreases gradually to zero [8].

The modulus of elasticity (E_c), and the modulus of rupture (f_r) for concrete (which are required in the ANSYS 12.1 analysis) are both calculated interms of the concrete compressive strength (f'_c), as follows [1]:

$$E_c = 4700\sqrt{f'_c} \tag{1}$$

$$f_r = 0.62\sqrt{f'_c} \tag{2}$$

The Poisson ratio for concrete is usually taken as 0.2 [4], [5].

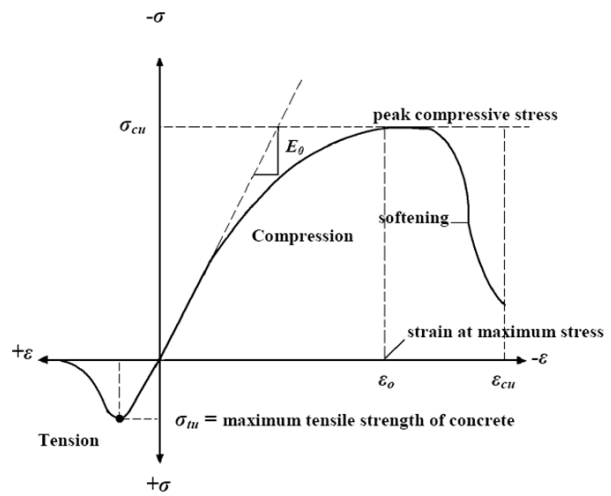

Fig. 3 Typical stress-strain curve for concrete [8]

The following equations are used to obtain a simplified stress-strain relationship for concrete [6], [8]:

$$f = E_c \epsilon / [1 + (\epsilon / \epsilon_0)^2] \tag{3}$$

$$\epsilon_0 = 2f'_c / E_c \tag{4}$$

$$E_c = f / \epsilon \tag{5}$$

where:

f : Stress at any strain ϵ

ϵ : Strain at stress f

ϵ_0 : Strain at the ultimate compressive strength f'_c

Fig. 4 shows this simplified relationship which is used in the present research:

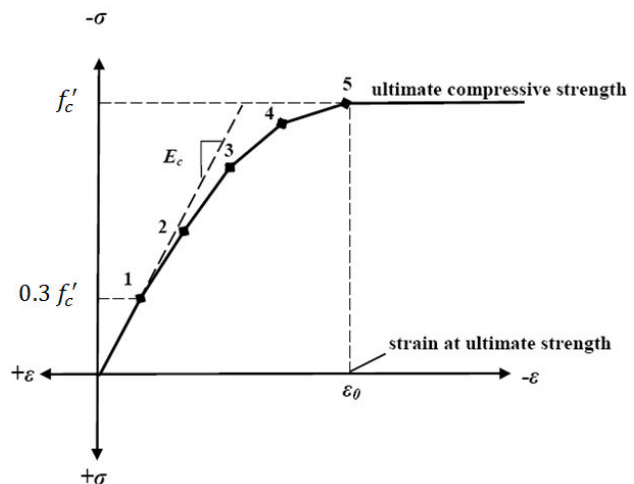

Fig. 4 Simplified compressive stress-strain curve for concrete [8]

Other parameters required to perform the finite element analysis are the shear transfer coefficients. These coefficients range from 0.0 to 1.0, with 0.0 representing a smooth crack (complete loss of shear transfer) and 1.0 representing a rough crack (no loss of shear transfer). This specification may be made for both the closed and open crack. When the element is cracked or crushed, a small amount of stiffness is added to the element for numerical stability [3].

B. Steel Bars

The bilinear model is used in the present to represent the stress-strain relationship for steel bars in the ANSYS 12.1 software. This elastic-perfectly plastic model is shown in Fig. 5.

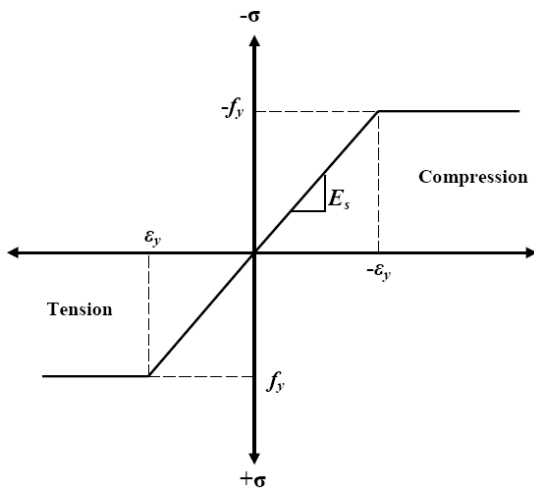

Fig. 5 Stress-strain curve for steel bars [8]

IV. EXPERIMENTAL DATA

The deep beam with two opening designated (S05-80-3), and tested by Tae Min Yoo [12] is considered in the present research to verify the effectiveness of the finite element model. This symmetric beam has the dimensions of 2400 mm x 600 mm x 110 mm, and contains two openings (120 mm x 120 mm each), as shown in Fig. 6. The beam is reinforced with two \varnothing 20 deformed bars with 20 mm clear cover. The material properties are: concrete compressive strength $f'_c = 94$ MPa, steel yield stress $F_y = 500$ MPa.

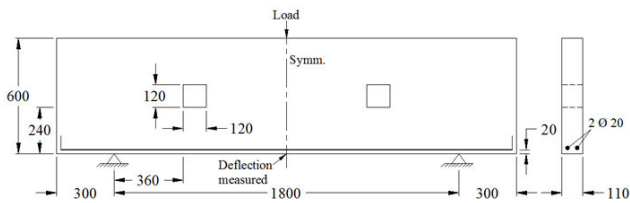

Fig. 6 Beam S05-80-3 [12]

Due to Symmetry; only half of the beam is considered in the ANSYS 12.1 analysis, as illustrated in Fig. 7. It is also possible to consider only one quarter of the beam, but this will

introduce some complexity on the boundary conditions of the problem.

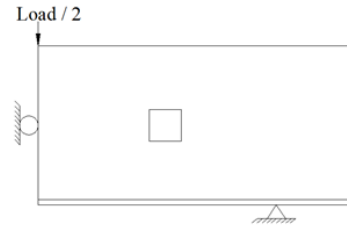

Fig. 7 Half of the beam S05-80-3 is considered due to symmetry

Fig. 8 illustrates the lines layout of the ANSYS 12.1 model for half of the beam.

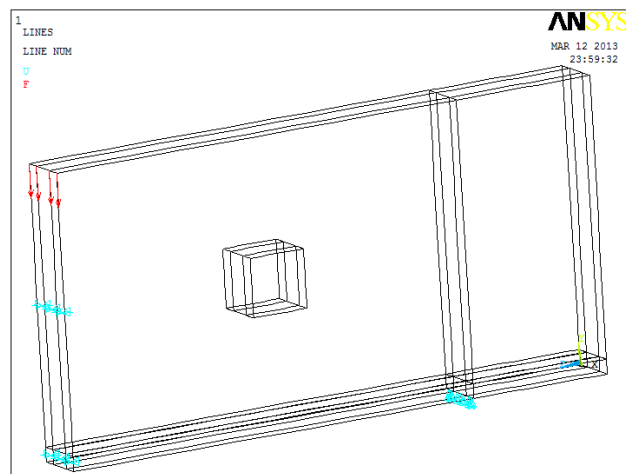

Fig. 8 ANSYS 12.1 model for half of the beam S05-80-3

Fig. 9 illustrates the finite element mesh for half of the deep beam under consideration. It is clear that the 6 node option (prism option) is used in the mesh. The mesh is fined near points of stress concentration.

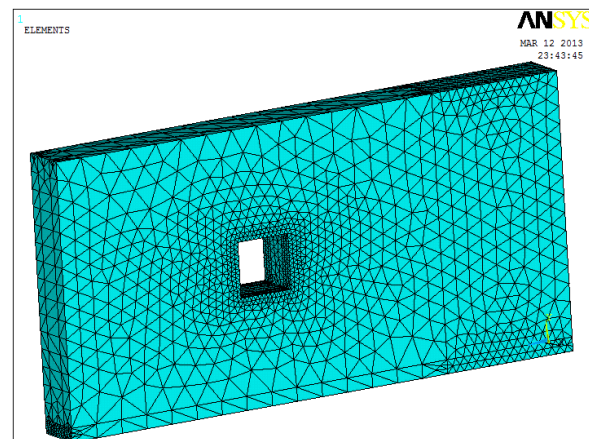

Fig. 9 ANSYS 12.1 modeling of the beam S05-80-3: (finite element mesh)

Fig. 10 shows the strain contour in concrete at failure, the darker the color, the higher the strain (absolute value).

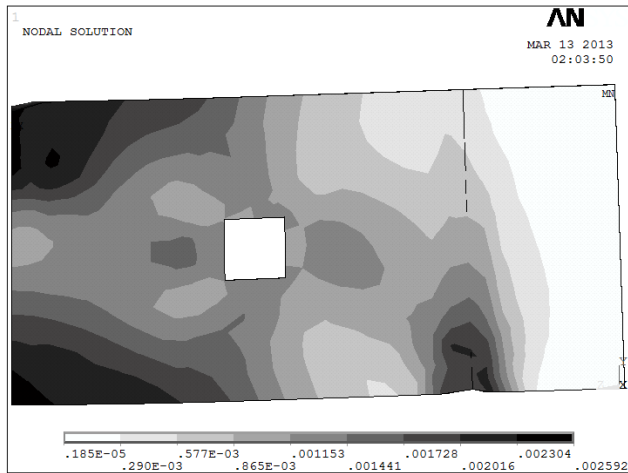

Fig. 10 ANSYS 12.1 modeling of the beam S05-80-3 (strain intensity)

Fig. 11 shows the cracks configuration for the deep beam with opening at failure [12], while Fig. 12 shows the experimental vs. the finite element results obtained by the present ANSYS 12.1 model. The difference in ultimate strength is about 20%.



Fig. 11 Crack pattern for beam S05-80-3 [12]

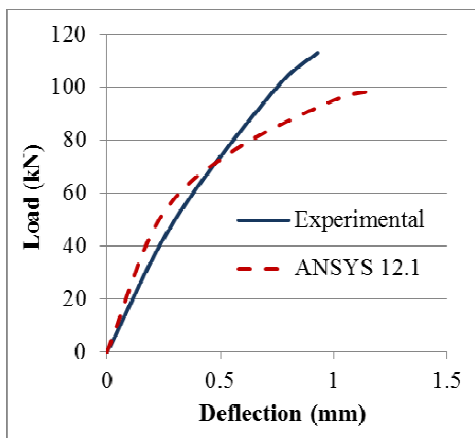

Fig. 12 Finite element vs. experimental results

V. PARAMETRIC STUDIES

Many techniques were suggested in the previous researches

to enhance the structural behavior of R.C deep and ordinary beams with opening [2], [5], [7], [9], [10]. However, the present work focuses on the effects of both opening location and shape, on increasing the structural strength of the reinforced concrete deep beam with opening. The following cases were studied to enhance the structural behavior of the deep beam S05-80-3, while keeping its opening size fixed at 14400 mm²:

A. Square Opening

In this case, the original beam S05-80-3 is analyzed with its 120 mm x 120 mm square opening, and several opening locations are considered. Fig. 13 illustrates half of the beam considered in this case, and Fig. 14 shows the ultimate strength for the beam versus the distance d_1 , for three values of the distance d_2 .

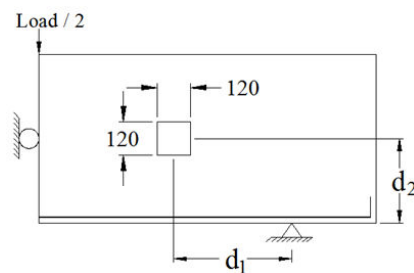

Fig. 13 Square opening

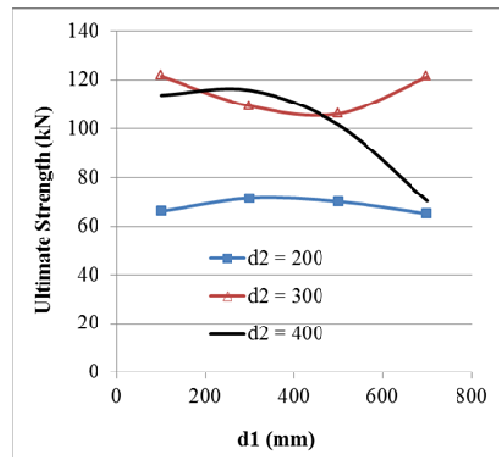

Fig. 14 Ultimate strengths for the beam with square opening

B. Rectangular Opening I

In this case, the square opening is replaced by a rectangular one (240 mm x 60 mm), with the long sides of the opening extended in the vertical direction.

Fig. 15 illustrates half of the beam considered in this case, and Fig. 16 shows the ultimate strength for the beam in this case versus the distance d_1 , for three values of the distance d_2 .

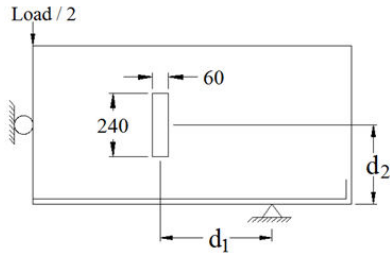

Fig. 15 Rectangular opening 1

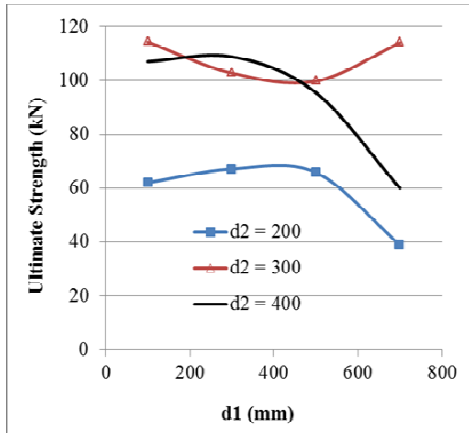

Fig. 16 Ultimate strengths for the beam with rectangular opening 1

C. Rectangular Opening 2

In this case, the rectangular opening 1 is replaced by the rectangular opening 2, which has the same dimensions but has long sides extended in the horizontal direction. Fig. 17 illustrates half of the beam considered in this case, and Fig. 18 shows the ultimate strength for the beam in this case versus the distance d_1 , for three values of the distance d_2 .

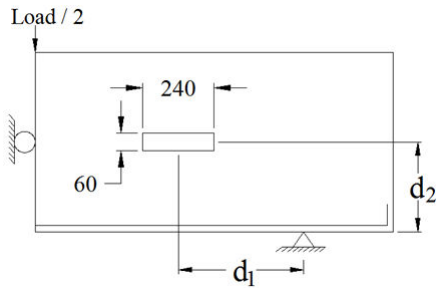

Fig. 17 Rectangular Opening 2

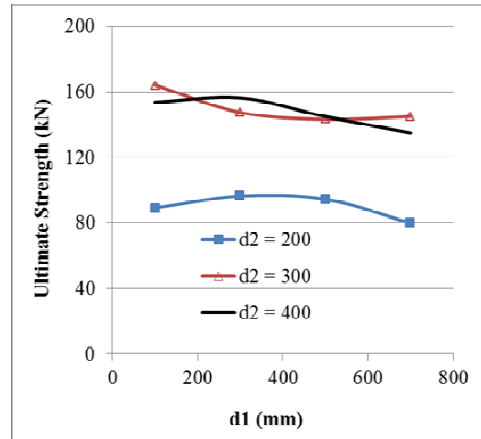

Fig. 18 Ultimate strengths for the beam with rectangular opening 2

D. Circular Opening

In this case, the square opening is replaced by a circular opening. Fig. 19 illustrates half of the beam considered in this case, and Fig. 20 shows the ultimate strength for the beam in this case versus the distance d_1 , for three values of the distance d_2 .

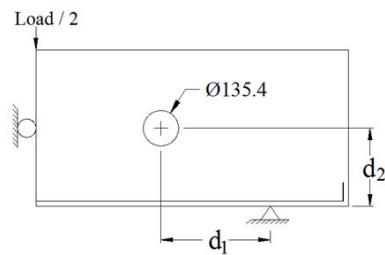

Fig. 19 Circular opening

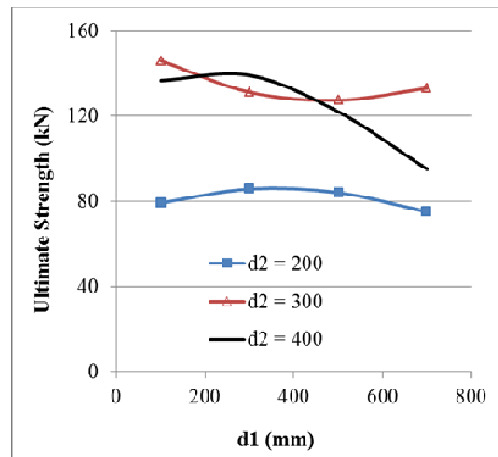

Fig. 20 Ultimate strengths for the beam with circular opening

VI. CONCLUSION

The finite element analysis implemented in the present work shows fair agreement with experimental data. Despite the complexity of the problem, which includes irregular stress

pattern (due to the presence of the opening); ANSYS 12.1 software was found completely efficient in handling such analysis. The load carrying capacity of deep beam with opening, obtained by using ANSYS 12.1 software, was 20% less than the experimental results, i.e. the ANSYS 12.1 model exhibits less strength than the experimental data.

The best shape for the opening, in the deep beam considered, is the narrow rectangular one, with the long sides extended in the horizontal direction. However, this shape may not be suitable in some practical cases. The use of circular opening has advantage over using square opening regarding the structural strength of the beam. The best location of the opening, regardless its shape, is far from the arching action and the flexure region, which is near the upper corners of the beam.

REFERENCES

- [1] ACI 318-08, American Concrete Institute, "Building code requirements for reinforced concrete," *American Concrete Institute, Farmington Hills, Michigan*, 2008.
- [2] A. Y. Ali, A. A. Ibrahim, and R. F. Yousif, "Analysis of reinforced concrete beams with openings and strengthened by (CFRP) laminates", *University of Babylon Magazine*, Vol. 19, No.3, p.p. 1098-1113, 2011.
- [3] ANSYS, ANSYS User's Manual Revision 12.1, ANSYS, Inc., Canonsburg, Pennsylvania, 2012.
- [4] H. R. C. S. Bandara, J. C. P. H. Gamage, Aravinda, and S. D. Weerakon, "FE modeling of CFRP strengthened concrete beam exposed to cyclic temperature, humidity and sustained loading", *Civil Engineering Research for Industry, Department of Civil Engineering, University of Moratuwa*, pp. 55-60, 2011.
- [5] S.C. Chin, N. Shafiq and M.F. Nuruddin, "Strengthening of RC beams with large openings in shear by CFRP laminates: experiment and 2D nonlinear finite element analysis", *Research Journal of Applied Sciences, Engineering and Technology* Vol. 4, No. 9, pp. 1172-1180, 2012.
- [6] C. Giuseppe and M. Giovanni, "Behavior of concrete deep beams with openings and low shear span-to-depth ratio", *Iraqi Virtual Science Library, Engineering Structures Journal*, Vol. 41, pp. 294-306, 2012.
- [7] K. G. Hemanth, "Experimental and numerical studies on behavior of FRP strengthened deep beams with openings", MSc thesis, Department of Civil Engineering, National Institute of Technology, Rourkela, 2012.
- [8] D. Kachlakev, T. Miller, S. Yim, K. Chansawat, and T. Potisuk, "Finite element modeling of reinforced concrete structures strengthened with FRP laminates", *Final Report SPR 316, Oregon Department of Transportation & Federal Highway Administration, USA*, 2001.
- [9] D. R. Sahoo and S. H. Chao, "Use of steel fiber reinforced concrete for enhanced performance of deep beams with large openings", *Structures Congress* © 2010 ASCE, pp. 1981-1990, 2010.
- [10] V. Vengatchalapathy and R. Ilangovan, "A study on steel fiber reinforced concrete deep beams with and without openings", *International Journal of Civil and Structural Engineering*, Vol. 1, No. 3, pp. 509- 517, 2010.
- [11] K. H. Yanga, H. C. Eunb, and H. S. Chungc, "The influence of web openings on the structural behavior of reinforced high-strength concrete deep beams", *Iraqi Virtual Science Library, Engineering Structures Journal*, Vol. 28, pp. 1825-1834, 2006.
- [12] T. M. Yoo, "Strength and behavior of high strength concrete deep beams with web openings", Ph.D. Thesis, Griffith School of Engineering, Griffith University, 2011.