

Partial Stabilization of a Class of Nonlinear Systems Via Center Manifold Theory

Ping He

Abstract—This paper addresses the problem of the partial state feedback stabilization of a class of nonlinear systems. In order to stabilize this class systems, the especial place of this paper is to reverse designing the state feedback control law from the method of judging system stability with the center manifold theory. First of all, the center manifold theory is applied to discuss the stabilization sufficient condition and design the stabilizing state control laws for a class of nonlinear. Secondly, the problem of partial stabilization for a class of plane nonlinear system is discuss using the *lyapunov second method* and the center manifold theory. Thirdly, we investigate specially the problem of the stabilization for a class of homogenous plane nonlinear systems, a class of nonlinear with dual-zero eigenvalues and a class of nonlinear with zero-center using the method of *lyapunov* function with homogenous derivative, specifically. At the end of this paper, some examples and simulation results are given show that the approach of this paper to this class of nonlinear system is effective and convenient.

Keywords—Partial stabilization, Nonlinear critical systems, Center manifold theory, *Lyapunov* function, System reduction.

I. INTRODUCTION

STABILIZATION is one of the basic tasks in control design. The asymptotic stability and stabilization of nonlinear systems have received significant attention [1]-[15].

The center manifold theory emerged in the sixties of the last century, Use of the center manifold method to stabilize control systems was proposed in [8] and else where, and soon became a powerful tool for the investigation of the stability of dynamic systems [9], [10]. Later it was used for the stabilization of nonlinear control systems [11], [12]. Then it was developed into a systematic design method.

Afterwards, the center manifold approach has been developed to solve the problem [1], [7], [11]-[13]. In [11], [12], some special nonlinear controls are designed to stabilize some particular control systems. The method used there is basically a *case-by-case study*.

Based on this generalized normal form, the center manifold approach developed for standard normal form has been extended to a much larger class of systems. A description of this was given in [14].

A systematic design technique was developed to provide a set of sufficient conditions for designing controls which stabilize the dynamics on the designed center manifold, and then stabilize the overall system [15]. Stabilization of a class of non-minimum phase nonlinear systems which have

zero dynamics with an eigenvalue zero of multiplicity 2 is considered [16]. The problem of the stabilization of affine nonlinear control systems via the design of a center manifold is considered [17]. The stabilization and stabilizability of nonlinear system in critical cases is studies [18] using the center manifold reduction, for the system whose linearization possess either a simple zero eigenvalue or a pair of simple, pure imaginary eigenvalues. The problem of stabilization of a class of nonlinear systems, which are possibly of non-minimum phase, is considers [19]. A cascade scheme for passivity-based stabilization of a wide class of nonlinear systems is proposed [20].

In some recent achievements of scientific researches. The finite-time stability problem for quadratic systems is studied in [21], and two sufficient conditions for finite-time stability analysis and finite-time stabilization via static state feedback are given. A weak concept of sampled-data feedback stabilization for the case of autonomous systems is presented and its *Lyapunov* characterization is established, and sufficient conditions are derived for the existence of a time-varying sampled-data feedback exhibiting global stabilization for certain class of nonlinear systems [22]. The problem of robust stabilization is considered for a class of nonlinear interconnected systems, which consist of linear subsystems coupled by nonlinear interconnections that are unknown and quadratically bounded, in [23]. The stabilization problem of a class of non-linear systems using contraction principle is studied and the contraction-based systematic design of control function is presented in [24]. A switching adaptive controller which tunes the dynamic gain depending on the nonlinearity structure is proposed, the stabilization or regulation of nonlinear systems with either triangular or feedforward nonlinearity is extended in [25]. Under some moderate assumptions, smooth decentralised state-feedback controllers are designed for a class of large-scale high-order stochastic non-linear systems which are neither necessarily feedback linearizable nor affine in the control input [26]. The problem of adaptive backstepping control for a class of single-input and single-output (SISO) non-linear time-delay systems in triangular structure is studied in [27]. The new H_∞ controller design schemes are provided for a class of discrete-time systems with uncertain non-linear perturbations [28]. The stabilization problem of non-linear systems with multi-uncontrollable modes on the imaginary axes is studied and the relation between the centre manifold and the feedback law is given in [29]. The output feedback stabilization of a class of nonlinear systems with nonlinearity of the unmeasured state variables is studied [30]. The problem of adaptive robust stabilization is considered for a class of nonlinear systems with

The corresponding author: 376055006@qq.com (Ping He).

Ping He is with Class 20081 of Automation subject in School of Automation and Electronic Information, Sichuan University of Science & Engineering, Zigong, Sichuan, 643000, P. R. China e-mail: 376055006@qq.com.

uncertainties which consist of uncertain system parameters and multiple external disturbances [31].

Based on these pioneer works, the main purpose of this paper is to provide a new design technique of state feedback control, and the designed state feedback control ensures that the dynamics on the designed center manifold of the closed-loop system is asymptotically stable, which is then extended to a general and large of nonlinear systems. To obtain the desirable properties and the state feedback control, we combining the center manifold method with the *Lyapunov* method as before. However, the especial place of this paper is to reverse designing the state feedback control law from the method of judging system stability with the center manifold theory.

This paper is organized as follows: In the *second section*, we recall some basic mathematical analysis with respect to the linearization approach of nonlinear systems and eigenvalues of the linearized systems model [10], [18], which will be employed in the remainder of this paper, commodiously. In the *third section*, the center manifold theory and several useful definitions and lemmas are briefly introduced.

In the *fourth section*. First of all, the center manifold theorem is applied to discuss the stabilization sufficient condition and design the stabilizing control laws for a general and large class of nonlinear control systems, which are presented. Secondly, the problem of partial stabilization for a class of plane nonlinear system is discuss using the *lyapunov second method* and the center manifold theory. Thirdly, this pre-existing approach is exhibited and investigated specially with the problem of the stabilization for three types of special nonlinear control systems which a class of homogenous plane nonlinear systems, a class of nonlinear with dual-zero eigenvalues and a class of nonlinear with zero-center using the method of *lyapunov* function with homogenous derivative, specifically. The class of homogenous plane nonlinear systems is studied using the method of polynomial reduction, the class of nonlinear with dual-zero eigenvalues and the class of nonlinear with zero-center are researched using the method of polynomial reduction, characteristics of their approximate system and the LFHD approach (that is, the *Lyapunov Function with Homogenous Derivative along solution curves approach* in [15]). The class of nonlinear with dual-zero eigenvalues is assumed to possess a pair of simple zero eigenvalues for primitive systems and the class of nonlinear with zero-center is assumed in the linearized model of primitive system with zero eigenvalues.

Finally. Some illustrative examples and simulations results are presented in the *fifth section*, which are results show that the approach of this paper which is proposed to the class of nonlinear system is effective and convenient. In the *sixth section* deals with some concluding and some open questions are presented in the *seventh section*.

II. PRELIMINARIES AND PROBLEM FORMULATION

In this section, we begin by recalling some well-known linearization approach from nonlinear system control and analysis to accomplish main work of this paper, commodiously and easily [10], [18].

In general, the linearization approach is a very popular and powerful method used to study the local stability as well as the local stabilization of smooth nonlinear autonomous systems.

Consider the general nonlinear autonomous system

$$\dot{x} = f(x). \quad (1)$$

Where $f : D \rightarrow R^n$ is continuously differentiable, D is a neighborhood of the origin $x = 0$. Suppose that the origin is an equilibrium point of the system (1), that is, $x(0) = 0$. By the *Lyapunov indirect method*, it is known that if the linearization of $f(x)$ at the origin, that is, the matrix

$$A = \left. \frac{\partial f(x)}{\partial x} \right|_{x=0}.$$

has all eigenvalues with strictly negative real parts, then the origin is asymptotical stable. If it has at least one eigenvalue has positive real part then the origin is unstable [4], [9], [21]. If the matrix A has some eigenvalues with zero real parts with the rest of the eigenvalues having negative real parts, then the linearization fails to determine the stability properties of the origin. This class of systems is the so-called *critical systems*, whose stability cannot be determined by using the approach of system linearization. The purpose of this paper is to discuss the stabilization of a class of nonlinear control system via center manifold reduction based on this class of critical systems.

Suppose now that $f(x)$ is twice continuously differentiable. The system (1) can be represented as below by the *Taylor* expansion

$$\dot{x} = Ax + \left[f(x) - \left. \frac{\partial f(x)}{\partial x} \right|_{x=0} x \right] = Ax + g(x).$$

where $g(x) = f(x) - \left. \frac{\partial f(x)}{\partial x} \right|_{x=0} x$ is also twice continuously differentiable and satisfies

$$g(0) = 0, \left. \frac{\partial g(x)}{\partial x} \right|_{x=0} = 0.$$

Suppose that A has k eigenvalues with zero real parts and m stable eigenvalues. Thus, it is easily to obtain a similarity transformation T that transforms A into a decoupled form, that is,

$$TAT^{-1} = \begin{bmatrix} A_{11} & 0 \\ 0 & A_{22} \end{bmatrix}.$$

where $Re[\lambda(A_{11})] = 0$ and A_{22} is *Hurwitz*. Clearly, A_{11} is $k \times k$ and A_{22} is $m \times m$. The change of variables

$$\begin{bmatrix} \eta \\ \xi \end{bmatrix} = Tx.$$

where $\eta \in R^k, \xi \in R^m$.

Thus, matrix T transforms the system (1) into the form

$$\begin{cases} \dot{\eta} = A_{11}\eta + F(\eta, \xi), \\ \dot{\xi} = A_{22}\xi + G(\eta, \xi). \end{cases} \quad (2)$$

Where A_{11} and A_{22} are constant matrices, and the function F and G are sufficiently smooth and inherit properties of g .

In particular, they are twice continuously differentiable and satisfies

$$\begin{cases} F(0,0) = 0, \\ \frac{\partial F(\eta,\xi)}{\partial \eta} \Big|_{(\eta,\eta)=(0,0)}, \\ \frac{\partial F(\eta,\xi)}{\partial \xi} \Big|_{(\eta,\eta)=(0,0)}, \\ G(0,0) = 0, \\ \frac{\partial G(\eta,\xi)}{\partial \eta} \Big|_{(\eta,\eta)=(0,0)}, \\ \frac{\partial G(\eta,\xi)}{\partial \xi} \Big|_{(\eta,\eta)=(0,0)}. \end{cases} \quad (3)$$

That is , their values and first derivatives vanishing at the origin.

III. PREPARE KNOWLEDGE

In this section, we giving some definitions and lemmas, which be found in [8]-[11], [16], [18], [32]-[35], are the key to the proof of main theorems of this paper, and will be useful in handling under investigation and proof of this paper.

Definition 1: [36] A manifold M of dimension k , or k -manifold, is a topological space with the following properties

- (i) M is Hausdorff,
- (ii) M is locally Euclidean of dimension n ,
- (iii) M has a countable basic of open sets.

Remark 1. [10] For our purpose here. A k -dimensional manifold in R^n ($1 \leq k \leq n$) is sufficient to think of a k -dimensional manifold as the solution of the equation

$$h(x) = 0.$$

where $f : R^n \rightarrow R^{n-k}$ is sufficiently smooth (that is, sufficiently many times continuously differentiable).

Definition 2: [10] A manifold $\{q(\xi) = 0\}$ is said to be an invariant manifold for the system (1) if

$$h(x(0)) = 0 \Rightarrow h(\xi(t)) \equiv 0, \forall t \in [0, t_1] \in R.$$

where $[0, t_1]$ is any time interval over which the solution $x(t)$ is defined.

Definition 3: [10] If $\xi = h(\eta)$ is an invariant manifold for the system (2) and h is smooth, then it is called a center manifold if

$$h(0) = 0, \frac{\partial h(\eta)}{\partial \eta} \Big|_{\eta=0} = 0.$$

Lemma 1: [10], [18] If F and G are twice continuously differentiable and satisfy equations (3), all eigenvalues of A_{11} have zero real parts, and all eigenvalues of A_{22} have negative real parts, then there exist a constant $\delta > 0$ and a continuously differentiable function $h(\eta)$, defined for all $\|\eta\| \leq \delta$, such that $\xi = h(\eta)$ is a center manifold for the system (2).

Lemma 2: [10], [18], [32]-[35] If $Re[\lambda(A_{22})] < 0$ and $Re[\lambda(A_{11})] = 0$, then there exists a constant $\delta > 0$ and a locally invariant manifold for the system (2) given by the graph of a C^2 function $\xi = h(\eta)$, $\eta < \delta$, where the function h satisfies

$$\frac{\partial h(\eta)}{\partial \eta} [A_{11}\eta + F(\eta, h(\eta))] = A_{22}h(\eta) + G(\eta, h(\eta)).$$

where $h(0) = 0$ and $\frac{\partial h(\eta)}{\partial \eta}$.

Moreover, the stability of the origin for system (2) coincides with the stability of the origin for the reduced system model (2), with ξ replaced by $h(\eta)$.

Furthermore, the system dynamics in the center manifold can be described as the following reduced system

$$\dot{\eta} = A_{11}\eta + F(\eta, h(\eta)) \quad (4)$$

Lemma 3: [8]-[11], [16], [18] Under assumptions of Lemma 1, if the origin $\eta = 0$ of the reduced system (4) is asymptotically stable then the origin of the full system (2) is asymptotically stable.

In the next section, we will frequently use these definitions and lemmas, and getting main results of this paper.

IV. MAIN RESULTS

We always hope that the state of the system can achieve stability under the action of a control law and such that it can avoid interference in the study process of nonlinear systems. So we making systems asymptotical stabilization which have much strong applicability. Due to the problem has certain practical application background in engineering field, so the studies of this paper has certain practical significance.

We study first the stabilization of a class of general nonlinear systems, and giving following results.

A. Stabilization of a Class of General Nonlinear Systems

Consider the general nonlinear control system based on the analysis of the Second Section

$$\begin{cases} \dot{x} = F(x, y), \\ \dot{y} = u + G(x, y). \end{cases} \quad (5)$$

where, $x \in R^n$, $y \in R^m$, the function F and G are sufficiently smooth and satisfied condition

$$\begin{cases} F(0,0) = 0, \\ Re\{\lambda[\frac{\partial F(x,y)}{\partial x} \Big|_{(x,y)=(0,0)}]\} = 0, \\ Re\{\lambda[\frac{\partial F(x,y)}{\partial y} \Big|_{(x,y)=(0,0)}]\} = 0, \\ G(0,0) = 0, \\ Re\{\lambda[\frac{\partial G(x,y)}{\partial x} \Big|_{(x,y)=(0,0)}]\} = 0, \\ Re\{\lambda[\frac{\partial G(x,y)}{\partial y} \Big|_{(x,y)=(0,0)}]\} = 0. \end{cases} \quad (6)$$

Theorem 1: If there is a vector field $y = h(x)$, and $h \in C^r$ ($r \geq 2$), $h(0) = 0$, $\frac{\partial h(x)}{\partial x} \Big|_{x=0} = 0$, such that the zero solution of subsystem of system (5)

$$\dot{x} = F(x, h(x)). \quad (7)$$

is asymptotically stable, that is, $F(x, h(x)) < 0$.

Then, there is a state feedback control law

$$u = \frac{\partial h(x)}{\partial x} F(x, y) - Bh(x) + By. \quad (8)$$

such that the system (5) is partial asymptotically stabilization in origin, where $u \in C^{r-1}$, B is a $m \times m$ constant matrix, whose real of eigenvalues are negative.

Proof. After substitution the state feedback control law (8) into the system (5), we can obtain the controlled closed-loop system as follows

$$\begin{cases} \dot{x} = F(x, y), \\ \dot{y} = By + \frac{\partial h(x)}{\partial x} F(x, y) - Bh(x) + G(x, y). \end{cases} \quad (9)$$

Marking, $\eta(x, y) = \frac{\partial h(x)}{\partial x} F(x, y) - Bh(x) + G(x, y)$, then $\eta(0, 0) = 0$, $\frac{\partial \eta(x, y)}{\partial y} |_{(x, y)=(0, 0)} = 0$.

Combining *Definitions 1-3* with *Lemma 1*, we can know, the $y = h(x)$ is the centre manifold of for the system (5).

And the zero solution of the subsystem (7) respect to the system (5) is asymptotically stable.

So, according to this and *Lemma 2-3*, we can know the system (5) is asymptotically stable in origin.

That is, the state feedback control law (8) such that the system (5) partial asymptotically stabilization in origin.

The *Theorem* is complete proof!

Remark 2. Without loss of generality, let $B = -I$ in a state feedback control law (8). Specifically, we can obtain that the state feedback control law is

$$u = \frac{\partial h(x)}{\partial x} F(x, y) + h(x) - y. \quad (10)$$

B. Stabilization of a Class of Plane Nonlinear Systems

Consider the following general plane nonlinear control system

$$\begin{cases} \dot{x} = F(x, y), \\ \dot{y} = u + G(x, y). \end{cases} \quad (11)$$

where $x \in R$, $y \in R^t$, $u \in R^t (t \geq 1)$, the function F and G are sufficiently smooth, and satisfied condition

$$\begin{cases} F(0, 0) = 0, \\ \frac{dF(x, y)}{dx} |_{(x, y)=(0, 0)} = 0, \\ \frac{\partial F(x, y)}{\partial y} |_{(x, y)=(0, 0)} = 0, \\ G(0, 0) = 0, \\ \frac{dG(x, y)}{dx} |_{(x, y)=(0, 0)} = 0, \\ \frac{\partial G(x, y)}{\partial y} |_{(x, y)=(0, 0)} = 0. \end{cases} \quad (12)$$

Theorem 2: If there is a vector field $y = h(x)$, $h \in C^r (r \geq 2)$, $h(0) = 0$, $\frac{\partial h(x)}{\partial x} |_{x=0} = 0$ and a positive constant δ such that $F(x, h(x)) < 0$ at $0 < x < \delta$ and $F(x, h(x)) > 0$ at $0 > x > -\delta$.

Then, there is a state feedback control law

$$u = \frac{\partial h(x)}{\partial x} F(x, y) + Bh(x) - By. \quad (13)$$

such that the system (11) is partial asymptotically stabilization in origin, where $u \in C^{r-1}$, B is a $t \times t$ constant matrix, whose real of eigenvalues are negative.

Proof. After substitution $y = h(x)$ into the subsystem of the system (11) we see that

$$\dot{x} = F(x, h(x)). \quad (14)$$

We can construct a *Lyapunov* function

$$V(x) = \frac{1}{2}x^2. \quad (15)$$

The all-derivatives of the *Lyapunov* function (15) along the track of subsystem (14) is

$$\dot{V}(x) |_{(14)} = xF(x, h(x)) < 0, \forall x \in (-\delta, +\delta) - \{0\}$$

According to the *Lyapunov second method*, we easy known the subsystem (14) is asymptotically stable in origin.

According to the *Theorem 1*, we can know the system (11) is partial asymptotically stabilization by the state feedback control law (13) in origin.

The *Theorem* is complete proof!

C. Stabilization of Class of Homogenous Plane Nonlinear Systems

Consider the following general homogenous plane nonlinear system

$$\begin{cases} \dot{x} = F(x, y), \\ \dot{y} = u + G(x, y). \end{cases} \quad (16)$$

where $x \in R$, $y \in R$, $u \in R$, the function F and G are sufficiently smooth, and satisfied condition

$$\begin{cases} F(0, 0) = 0, \\ \frac{dF(x, y)}{dx} |_{(x, y)=(0, 0)} = 0, \\ \frac{dF(x, y)}{dy} |_{(x, y)=(0, 0)} = 0, \\ G(0, 0) = 0, \\ \frac{dG(x, y)}{dx} |_{(x, y)=(0, 0)} = 0, \\ \frac{dG(x, y)}{dy} |_{(x, y)=(0, 0)} = 0. \end{cases} \quad (17)$$

The times of lowest order nonzero item of F is $m (m > 2)$, so F can be expressed as

$$F(x, y) = a_0x^m + a_1x^{m-1}y + a_2x^{m-2}y^2 + \dots + a_{m-1}xy^{m-1} + a_my^m + O(\|(x, y)\|^m).$$

The times of lowest order nonzero item of G is $n (n > 2)$, so G can be expressed as

$$G(x, y) = b_0x^n + b_1x^{n-1}y + b_2x^{n-2}y^2 + \dots + b_{n-1}xy^{n-1} + b_ny^n + O(\|(x, y)\|^n).$$

Suppose that the a_j is the first nonzero number of $F(x, y)$ in $a_0, a_1, a_2, \dots, a_m$.

Then the system (16) can be written for

$$\begin{cases} \dot{x} = a_jx^{m-j}y^j + \dots + a_{m-1}xy^{m-1} + a_my^m + O(\|(x, y)\|^m), \\ \dot{y} = u + b_0x^n + b_1x^{n-1}y + b_2x^{n-2}y^2 + \dots + b_{n-1}xy^{n-1} + b_ny^n + O(\|(x, y)\|^n). \end{cases} \quad (18)$$

Theorem 3: If there is a vector field $y = h(x) = x^p$, m and p are odds which are more than one, $a_j < 0$, such that $O(\|(x, y)\|^m) |_{y=h(x)} = O(\|(x, y)\|^{m+(p-1)j})$.

Then, there is a state feedback control law

$$u = \frac{dh(x)}{dx} F(x, y) + bh(x) - by. \quad (19)$$

such that the system (16) is partial asymptotically stabilization in origin, where $u \in C^{r-1}$, b is a positive constant.

Proof. We can obtain the subsystem respect to the system (16) as follows

$$xF(x, y) = x(a_jx^{m-j}y^j + \dots + a_{m-1}xy^{m-1} + a_my^m + O(\|(x, y)\|^m)). \quad (20)$$

After substitution $y = h(x) = x^p$ into the subsystem (20) we see that the subsystem (20) can be written for

$$xF(x, h(x)) = pa_j x^{m+(p-1)j+1} + O(\| (x) \|^{m+(p-1)j+1}).$$

And we have, m and p are odds which are more than one, and $a_j < 0$, so $m + (p - 1)j + 1$ is a even and $pa_j < 0$.

Thus, there must be

$$xF(x, h(x)) < 0, \forall x \in (-\delta, \delta) - \{0\}.$$

where δ is a very small positive.

According to the *Theorem 2*, we can known the system (16) is partial asymptotically stabilization by the state feedback control law (19) in origin.

The *Theorem* is complete proof!

Theorem 4: If there is a vector field $y = h(x) = x^p$, m and p are evens that are more than zero, j is a odd, $a_j < 0$, such that $O(\| (x, y) \|^{m+(p-1)j})|_{y=h(x)} = O(\| (x, y) \|^{m+(p-1)j})$.

Then, there is a state feedback control law

$$u = \frac{dh(x)}{dx} F(x, y) + bh(x) - by. \quad (21)$$

such that the system (16) is partial asymptotically stabilization in origin, where $u \in C^{r-1}$, b is a positive constant.

Proof. The proof of the *theorem 4* is similar with the *theorem 3*. We can obtain the subsystem respect to the system (16) as follows

$$xF(x, y) = x(a_j x^{m-j} y^j + \dots + a_{m-1} x y^{m-1} + a_m y^m + O(\| (x, y) \|^{m+1})). \quad (22)$$

Substitution $y = h(x) = x^p$ into the subsystem (22), thus, the subsystem (22) can be written for

$$xF(x, h(x)) = pa_j x^{m+(p-1)j+1} + O(\| (x) \|^{m+(p-1)j+1}).$$

Because m and p are evens which are more than zero, j is a odd, $a_j < 0$, so $m + (p - 1)j + 1$ is a even and $pa_j < 0$. There must is a neighborhood which contains the origin such that

$$xF(x, h(x)) < 0, \forall x \in (-\delta, \delta) - \{0\}.$$

where δ is a very small positive.

According to the *Theorem 2*, we can known the system (16) is partial asymptotically stabilization by the state feedback control law (21) in origin.

The *Theorem* is complete proof!

From now on, we study the stability of the dynamics response on center manifold through its approximated systems, and giving following results.

D. Stabilization of a Class of Nonlinear Systems with Dual-zero Eigenvalues

Consider the following nonlinear system

$$\begin{cases} \begin{bmatrix} \dot{x}_1 \\ \dot{x}_2 \end{bmatrix} = \begin{bmatrix} 0 & a \\ 0 & 0 \end{bmatrix} \begin{bmatrix} x_1 \\ x_2 \end{bmatrix} + \begin{bmatrix} f_1(x_1, x_2, y) \\ f_2(x_1, x_2, y) \end{bmatrix} \\ \dot{y} = u + G(x, y). \end{cases} \quad (23)$$

where $x_1 \in R, x_2 \in R, y \in R, u \in R$, the function $F(x, y) = \begin{bmatrix} f_1(x_1, x_2, y) \\ f_2(x_1, x_2, y) \end{bmatrix} \in C^\infty$, $G(x, y)$ is sufficiently smooth, as well. And them are satisfied condition

$$\begin{cases} F(0, 0) = 0, \\ \frac{\partial F(x, y)}{\partial x} |_{(x, y)=(0,0)} = 0, \\ \frac{dF(x, y)}{dy} |_{(x, y)=(0,0)} = 0, \\ G(0, 0) = 0, \\ \frac{\partial G(x, y)}{\partial x} |_{(x, y)=(0,0)} = 0, \\ \frac{dG(x, y)}{dy} |_{(x, y)=(0,0)} = 0, \end{cases} \quad (24)$$

Suppose that the equation $f_2(x_1, x_2, y)$ can be written for

$$f_2(x_1, x_2, y) = f_0(x_1, x_2) + f_3(x_1, x_2, y)y.$$

Let $y = h(x) = h(x_1, x_2)$, and $h \in C^2(r \geq 2)$, $h(0) = 0$, $\frac{\partial h(x)}{\partial x} |_{(x_1, x_2)=(0,0)} = 0$.

Substitution $y = h(x)$ into the $f_2(x_1, x_2, y)$. And suppose that the times of lowest order nonzero item of $f_2(x_1, x_2, y)$ is k , and k is a odd, thus, the $f_2(x_1, x_2, y)$ can be expressed as

$$f_2(x_1, x_2, h(x_1, x_2)) = a_0 x_1^k + a_1 x_1^{k-1} x_2 + \dots + a_k x_2^k + O(\| (x_1, x_2) \|^{k+1}).$$

And after substitution $y = h(x)$ into the system (23) we see that the system (23) can be written for

$$\begin{cases} \dot{x}_1 = ax_2 + f_1(x_1, x_2, h(x_1, x_2)), \\ \dot{x}_2 = a_0 x_1^k + a_1 x_1^{k-1} x_2 + \dots + a_k x_2^k + O(\| (x_1, x_2) \|^{k+1}), \\ \dot{y} = u + G(x, y). \end{cases} \quad (25)$$

The approximate system of the system (23) is

$$\begin{cases} \dot{x}_1 = ax_2, \\ \dot{x}_2 = \sum_{i=0}^k a_i x_1^{k-i} x_2, \\ \dot{y} = u + G(x, y). \end{cases} \quad (26)$$

Theorem 5: For the approximate system (26) of the system (23), if there are $\lambda_1 > 0, \lambda_2 > 0$ such that $\lambda_1 a + \lambda_2 a_0 = 0$, and $a_{2i} = 0 (i = 1, 2, \dots, \frac{k-1}{2})$, $a_i \leq 0 (i = 1, 3, 5, \dots, k - 2)$, $a_k < 0$.

Then, there is a state feedback control law

$$u = \frac{\partial h(x)}{\partial x} \begin{bmatrix} ax_2 + f_1(x_1, x_2, y) \\ f_2(x_1, x_2, y) \end{bmatrix} + bh(x_1, x_2) - by. \quad (27)$$

such that the system (23) is partial asymptotically stabilization in origin, where $u \in C^{r-1}$, b is a positive constant, $y = h(x_1, x_2)$, and $h \in C^2(r \geq 2)$, $h(0) = 0$, $\frac{\partial h(x)}{\partial x} |_{x=0} = 0$.

Proof. According to the LFHD approach in [15], without loss of generality, we can construct a *Lyapunov function*

$$V(x) = \frac{\lambda_1}{k+1} x_1^{k+1} + \frac{\lambda_2}{2} x_2^2. \quad (28)$$

The all-derivatives of *Lyapunov function* (28) along the

track of approximate system (26) is

$$\begin{aligned} \dot{V}(x) |_{(26)} &= \lambda_1 a x_1^k x_2 + \lambda_2 x_2 (a_0 x_1^k \\ &\quad + a_1 x_1^{k-1} x_2 + \dots + a_k x_2^k) \\ &= (\lambda_1 a + \lambda_2 a_0) x_1^k x_2 \\ &\quad + \lambda_2 (a_1 x_1^{k-1} x_2^2 + a_2 x_1^{k-2} x_2^3 \\ &\quad + \dots + a_k x_2^{k+1}) \\ &= \lambda_2 (a_1 x_1^{k-1} x_2^2 + a_2 x_1^{k-2} x_2^3 \\ &\quad + \dots + a_k x_2^{k+1}) \\ &\leq 0. \end{aligned}$$

Let $\dot{V}(x) |_{(26)} = 0$, we have $x_2 = 0$. After substitution $x_2 = 0$ into the approximate system (26) we see that $\dot{V}(x) |_{(26)} = 0$ if and only if $(x_1, x_2) = (0, 0)$.

According to the *Lyapunov second method* and *Theorem 1*, we easy known that the approximate system (26) is partial asymptotically stable by the state feedback control law (27) in origin.

According to the *theorem of the third section* in [15], we can known that the system (23) is partial asymptotically stabilization by the state feedback control law (27) in origin.

The *Theorem* is complete proof!

E. Stabilization of a Class of Nonlinear Systems with Non-center

Consider the following general non-center nonlinear control system

$$\begin{cases} \begin{bmatrix} \dot{x}_1 \\ \dot{x}_2 \end{bmatrix} = \begin{bmatrix} f_1(x_1, x_2, y) \\ f_2(x_1, x_2, y) \end{bmatrix} \\ \dot{y} = u + G(x, y). \end{cases} \quad (29)$$

where $x_1 \in R, x_2 \in R, y \in R, u \in R$, the function $F(x, y) = \begin{bmatrix} f_1(x_1, x_2, y) \\ f_2(x_1, x_2, y) \end{bmatrix} \in C^\infty$, $G(x, y)$ is sufficiently smooth, as well. And them are satisfied condition

$$\begin{cases} F(0, 0) = 0, \\ \frac{\partial F(x, y)}{\partial x} |_{(x, y)=(0, 0)} = 0, \\ \frac{dF(x, y)}{dy} |_{(x, y)=(0, 0)} = 0, \\ G(0, 0) = 0, \\ \frac{\partial G(x, y)}{\partial x} |_{(x, y)=(0, 0)} = 0, \\ \frac{dG(x, y)}{dy} |_{(x, y)=(0, 0)} = 0, \end{cases} \quad (30)$$

Suppose that the times of lowest order nonzero item of $f_i(x_1, x_2, y)$ is k_i , and k_i is a odd, where $i = 1, 2$, thus, the $f_i(x_1, x_2, y)$ can be expressed as

$$f_1(x_1, x_2, y) = \sum_{i=0}^{k_1} c_i x_1^{k_1-i} x_2^i + y(\phi_1(x_1, x_2, y)) + O(\|((x_1, x_2, y))\|^{k_1+1}).$$

and

$$f_2(x_1, x_2, y) = \sum_{i=0}^{k_2} d_i x_1^i x_2^{k_2-i} + y(\phi_2(x_1, x_2, y)) + O(\|((x_1, x_2, y))\|^{k_2+1}).$$

where $\phi_i(x_1, x_2, y)$ is a $k_i - 1$ order times polynomial.

Let $y = h(x) = h(x_1, x_2)$, and $h \in C^2(r \geq 2)$, $h(0) = 0$, $\frac{\partial h(x)}{\partial x} |_{x=0} = 0$. After substitution $y = h(x_1, x_2)$ into the $f_i(x_1, x_2, y)$ we see that the $f_i(x_1, x_2, y)$ can be written for

$$f_1(x_1, x_2, h(x_1, x_2)) = \sum_{i=0}^{k_1} c_i x_1^{k_1-i} x_2^i + O(\|((x_1, x_2))\|^{k_1}).$$

and

$$f_2(x_1, x_2, h(x_1, x_2)) = \sum_{i=0}^{k_2} d_i x_1^i x_2^{k_2-i} + O(\|((x_1, x_2))\|^{k_2}).$$

Thus, the system (29) can be written for

$$\begin{cases} \dot{x}_1 = \sum_{i=0}^{k_1} c_i x_1^{k_1-i} x_2^i + O(\|((x_1, x_2, y))\|^{k_1}), \\ \dot{x}_2 = \sum_{i=0}^{k_2} d_i x_1^i x_2^{k_2-i} + O(\|((x_1, x_2, y))\|^{k_2}), \\ \dot{y} = u + G(x, y). \end{cases} \quad (31)$$

The approximate system of the system (29) is

$$\begin{cases} \dot{x}_1 = \sum_{i=0}^{k_1} c_i x_1^{k_1-i} x_2^i, \\ \dot{x}_2 = \sum_{i=0}^{k_2} d_i x_1^i x_2^{k_2-i}, \\ \dot{y} = u + G(x, y). \end{cases} \quad (32)$$

Theorem 6: For the approximate system (32) of the system (29), if there are $m > 0$ and $2m > \max\{k_1, k_2\}$ such that

$$\begin{cases} -c_0 > \sum_{i=1}^{k_1} (|c_i| \frac{2m-i}{2m}) + \sum_{i=1}^{k_2} (|d_i| \frac{i}{2m}), \\ -d_0 > \sum_{i=1}^{k_1} (|c_i| \frac{i}{2m}) + \sum_{i=1}^{k_2} (|d_i| \frac{2m-i}{2m}). \end{cases} \quad (33)$$

Then, there is a state feedback control law

$$u = \frac{\partial h(x)}{\partial x} \begin{bmatrix} f_1(x_1, x_2, y) \\ f_2(x_1, x_2, y) \end{bmatrix} + bh(x_1, x_2) - by. \quad (34)$$

such that the system (29) is partial asymptotically stabilization in origin, where $u \in C^{r-1}$, b is a positive constant, $y = h(x_1, x_2)$, and $h \in C^2(r \geq 2)$, $h(0) = 0$, $\frac{\partial h(x)}{\partial x} |_{x=0} = 0$.

Proof. According to the LFHD approach in [15], without loss of generality, we can construct a *Lyapunov* function

$$V(x) = \frac{1}{2m-k_1+1} x_1^{2m-k_1+1} + \frac{1}{2m-k_2+1} x_2^{2m-k_2+1}. \quad (35)$$

The all-derivatives of the *Lyapunov* function (35) along the

track of the approximate system (32) is

$$\begin{aligned}
 \dot{V}(x) |_{(32)} &= x_1^{2m-k_1} \sum_{i=0}^{k_1} c_i x_1^{k_1-i} x_2^i \\
 &\quad + x_2^{2m-k_2} \sum_{i=0}^{k_2} d_i x_1^i x_2^{k_2-i} \\
 &= c_0 x_1^{2m} + \sum_{i=1}^{k_1} c_i x_1^{2m-i} x_2^i \\
 &\quad + d_0 x_2^{2m} + \sum_{i=1}^{k_2} d_i x_1^i x_2^{2m-i} \\
 &\leq c_0 x_1^{2m} \\
 &\quad + \sum_{i=1}^{k_1} |c_i| \left(\frac{2m-i}{2m} x_1^{2m} + \frac{i}{2m} x_2^{2m} \right) \\
 &\quad + d_0 x_2^{2m} \\
 &\quad + \sum_{i=1}^{k_2} |d_i| \left(\frac{i}{2m} x_1^{2m} + \frac{2m-i}{2m} x_2^{2m} \right) \\
 &= [c_0 + \sum_{i=1}^{k_1} (|c_i| \frac{2m-i}{2m}) \\
 &\quad + \sum_{i=1}^{k_2} (|d_i| \frac{i}{2m})] x_1^{2m} \\
 &\quad + [d_0 + \sum_{i=1}^{k_1} (|c_i| \frac{i}{2m}) \\
 &\quad + \sum_{i=1}^{k_2} (|d_i| \frac{2m-i}{2m})] x_2^{2m} \\
 &\leq 0.
 \end{aligned} \tag{36}$$

Add $\dot{V}(x) |_{(32)} \equiv 0$ (that is, all five equals signs in equation (36) are established.) if and only if $(x_1, x_2) = (0, 0)$.

According to the *Lyapunov second method* and *Theorem 1*, we easy known the system (32) is asymptotically stable by the state feedback control law (34) in origin.

According to the *theorem 4.1* in [15], we can known the system (29) is partial asymptotically stabilization by the state feedback control law (34) in origin.

The *Theorem* is complete proof!

V. SYSTEM SIMULATION

In this section, in order to show that the approach of this paper to this sore of control system is effective and convenient, we give some illustrative examples and simulation results for each *Theorem*.

Example 1: Considering the following fourth order system for *Theorem 1*

$$\begin{cases}
 \dot{x}_1 = -x_1^3 - y_1^2, \\
 \dot{x}_2 = -x_2 - y_2^2, \\
 \dot{y}_1 = u_1 + x_1^2 x_2^2 y_1, \\
 \dot{y}_2 = u_2 + x_1 x_2^3 y_2.
 \end{cases} \tag{37}$$

Solution. we can easy know that the function F and G are sufficiently smooth and satisfied condition (6) in this system (37).

Without loss of generality. Let $y = h(x) = \begin{bmatrix} x_1^2 \\ x_2^2 \end{bmatrix}$, and $h \in C^2(r \geq 2)$, $h(0) = 0$, $\frac{\partial h(x)}{\partial x} |_{x=0} = 0$.

After substitution into the subsystem respect to the system (37) we see that

$$\begin{cases}
 \dot{x}_1 = -x_1^3 - x_1^4, \\
 \dot{x}_2 = -x_2 - x_2^4.
 \end{cases}$$

Add $\forall x \in D - \{0\}$, there must be

$$\begin{cases}
 \dot{x}_1 = -x_1^3 - x_1^4 < 0, \\
 \dot{x}_2 = -x_2 - x_2^4 < 0.
 \end{cases}$$

where D is a neighborhood which contains the origin.

So we easy to check that the system (37) satisfies the conditions of *Theorem 1*.

Thus, there is a state feedback control law

$$u = \begin{bmatrix} 2x_1 & 0 \\ 0 & 2x_2 \end{bmatrix} \begin{bmatrix} -x_1^3 - y_1^2 \\ -x_2 - y_2^2 \end{bmatrix} - \begin{bmatrix} -2 & 0 \\ 0 & -2 \end{bmatrix} \begin{bmatrix} x_1^2 \\ x_2^2 \end{bmatrix} + \begin{bmatrix} -2 & 0 \\ 0 & -2 \end{bmatrix} \begin{bmatrix} y_1 \\ y_2 \end{bmatrix}. \tag{38}$$

such that the system (37) is partial asymptotically stabilization in origin.

That is,

$$u = \begin{bmatrix} -2x_1^4 - 2x_1 y_1^2 + 2x_1^2 - 2y_1^2 \\ -2x_2^2 - 2x_2 y_2^2 + 2x_2^2 - 2y_2^2 \end{bmatrix}.$$

Simulation. Without loss of generality. Let the initial value of simulation

$$\begin{cases}
 x_1(0) = 0.8, \\
 x_2(0) = -0.6, \\
 y_1(0) = 0.9, \\
 y_2(0) = -0.45.
 \end{cases}$$

and the input control signal

$$u = \begin{cases} 0, & \text{for } t < 0, \\ 1, & \text{for } t \geq 0. \end{cases}$$

The sample time is 0.1s, and the simulation time are 100s seconds.

The simulation structure diagram of the system (37) is show in Fig. 1.

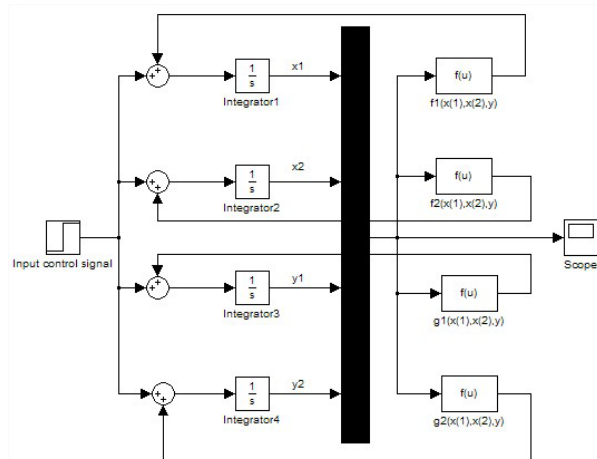

Fig. 1: Simulation structure diagram of the system (37).

The dynamic response of the system (37) without the state feedback control law (38) is show in Fig. 2.

The dynamic response of the system (37) with the state feedback control law (38) is show in Fig. 3.

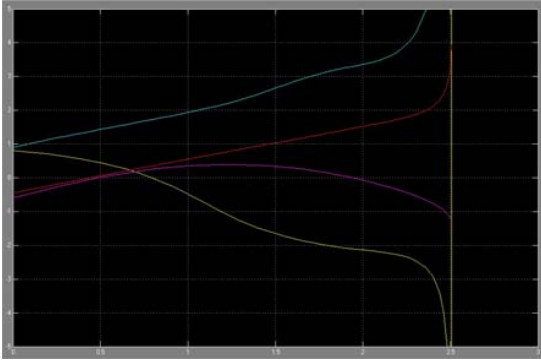

Fig. 2: Dynamic response of the system (37) without the state feedback control law (38).

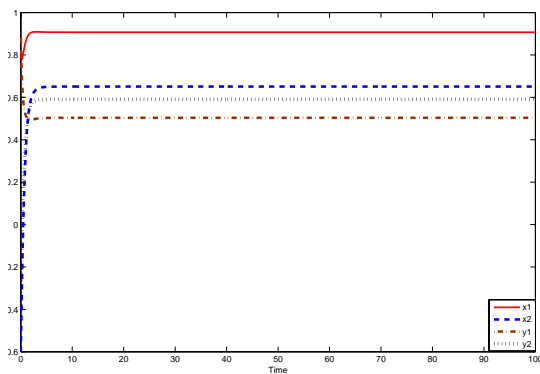

Fig. 3: Dynamic response of the system (37) with the state feedback control law (38).

From the Figure 2, we can know that the opened-loop system respect to the system (37) is unstable, and from the Fig. 3, we can know that the controlled closed-loop system of the system (37) is asymptotically stable. That is, the approach presented in this paper to this sort of systems is effective.

Example 2: Considering the following second order system for *Theorem 2*

$$\begin{cases} \dot{x} = -3x^3 + x^2y^2 + y^3, \\ \dot{y} = u + xy^2 + x^2y. \end{cases} \quad (39)$$

Solution. we can easy know that the function F and G are sufficiently smooth and satisfied condition (12) in the system (39).

Without loss of generality. Let $y = h(x) = x^3$. $h \in C^2(r \geq 2)$, $h(0) = 0$, $\frac{dh(x)}{dx} |_{x=0} = 0$.

After substitution into the subsystem respect to the system (39) we see that

$$\dot{x} = -3x^3 + x^2(x^3)^2 + (x^3)^3.$$

Add $\forall x \in D - \{0\}$, there must be

$$-3x^3 + x^2(x^3)^2 + (x^3)^3 < 0, \forall 0 < x < \delta.$$

and

$$-3x^3 + x^2(x^3)^2 + (x^3)^3 > 0, \forall 0 > x > -\delta.$$

where δ is a very small positive.

So we easy to check that the system (39) satisfies the conditions of *Theorem 2*.

Then, there is a state feedback control law

$$u = 3x^2(-3x^3 - x^2y^2 + y^3) + 2x^3 - 2y. \quad (40)$$

such that the system (49) is partial asymptotically stabilization in origin.

Simulation. Without loss of generality. Let the initial value of simulation

$$\begin{cases} x(0) = 0.8, \\ y(0) = 0.2. \end{cases}$$

and the input control signal

$$u = \begin{cases} 0, & \text{for } t < 0, \\ 0.4, & \text{for } t \geq 0. \end{cases}$$

The sample time is 0.1s, and the simulation time are 20s seconds.

The simulation structure diagram of the system (39) is show in Fig. 4.

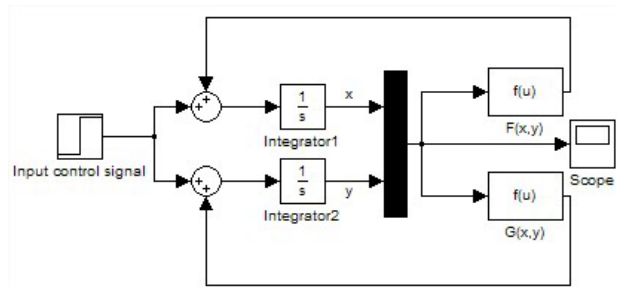

Fig. 4: Simulation structure diagrams of system (39), system (41) and system (43).

The dynamic response of the system (39) without the state feedback control law (40) is show in Fig. 5.

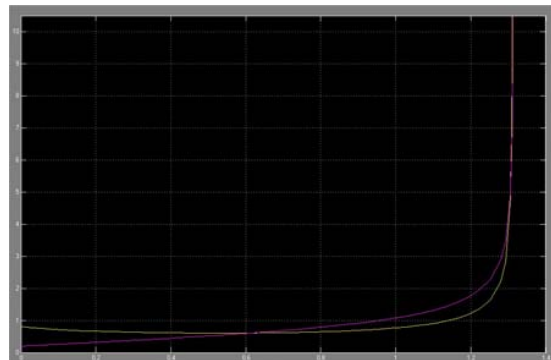

Fig. 5: Dynamic response of the system (39) without the state feedback control law (40).

The dynamic response of the system (39) with the state feedback control law (40) is show in Fig. 6.

From the Figure 5, we can know that the opened-loop system respect to the system (39) is unstable, and from the Fig. 6, we can know that the controlled closed-loop system of

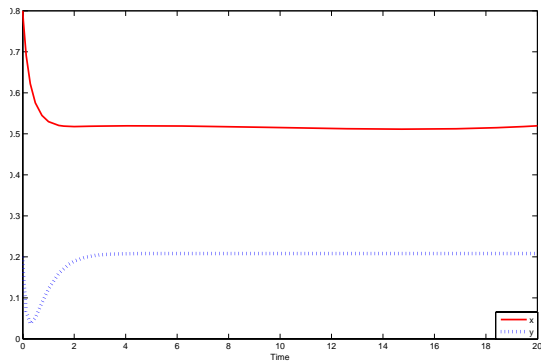

Fig. 6: Dynamic response of the system (39) with the state feedback control law (40).

the system (39) is asymptotically stable. That is, the approach presented in this paper to this sort of systems is effective.

Example 3: Considering the following second order system for *Theorem 3*

$$\begin{cases} \dot{x} = -3x^2y + xy^2, \\ \dot{y} = u + xy. \end{cases} \quad (41)$$

Solution. we can easy know that the function F and G are sufficiently smooth and satisfied condition (17) in the system (41).

Without loss of generality. Let $y = h(x) = x^3, h \in C^2(r \geq 2), h(0) = 0, \frac{dh(x)}{dx} |_{x=0} = 0$.

Add $m = 2 + 1 = 3, p = 3, a_j = -3 < 0$.

So it's easy to check that the system (41) satisfies the conditions of *Theorem 3*.

Then, there is a state feedback control law

$$u = 3x^2(-3x^2y + xy^2) + x^3 - y. \quad (42)$$

such that the system (41) is partial asymptotically stabilization in origin.

Simulation. Without loss of generality. Let the initial value of simulation

$$\begin{cases} x(0) = -0.4, \\ y(0) = 0. \end{cases}$$

and the input control signal

$$u = \begin{cases} 0, & \text{for } t < 0, \\ 0.1, & \text{for } t \geq 0. \end{cases}$$

The sample time is 0.01s, and the simulation time are 100s seconds.

The simulation structure diagram of the system (41) is show in Fig. 4.

The dynamic response of the system (41) without the state feedback control law (42) is show in Fig. 7.

The dynamic response of the system (41) with the state feedback control law (42) is show in Fig. 8.

From the Figure 7, we can know that the opened-loop system respect to the system (41) is unstable, and from the Fig. 8, we can know that the controlled closed-loop system of

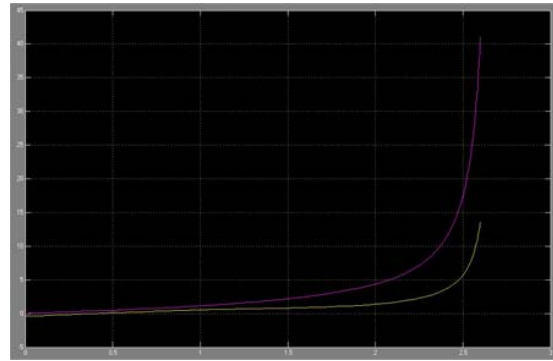

Fig. 7: Dynamic response of the system (41) without the state feedback control law (42).

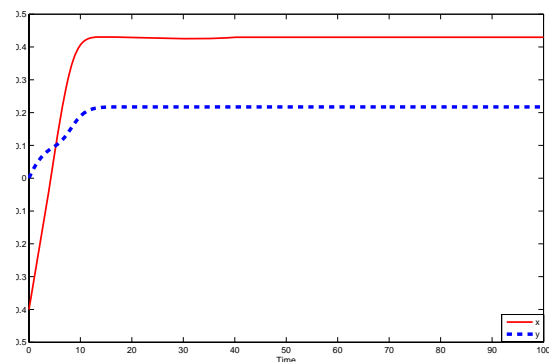

Fig. 8: Dynamic response of the system (41) with the state feedback control law (42).

the system (41) is asymptotically stable. That is, the approach presented in this paper to this sort of systems is effective.

Example 4: Considering the following second order system for *Theorem 4*

$$\begin{cases} \dot{x} = -x^3y + x^2y^2, \\ \dot{y} = u + 2x^3 + xy^2. \end{cases} \quad (43)$$

Solution. we can easy know that the function F and G are sufficiently smooth and satisfied condition (17) in the system (43).

Without loss of generality. Let $y = h(x) = x^2, h \in C^2(r \geq 2), h(0) = 0, \frac{dh(x)}{dx} |_{x=0} = 0$.

Add $m = 3 + 1 = 4, p = 2, a_j = -1 < 0$.

So it's easy to check that the system (43) satisfies the conditions of *Theorem 4*.

Then, there is a state feedback control law

$$u = 2x(-x^3y + x^2y^2) + x^2 - y. \quad (44)$$

such that the system (43) is partial asymptotically stabilization in origin.

Simulation. Without loss of generality. Let the initial value of simulation

$$\begin{cases} x(0) = -1, \\ y(0) = -0.1. \end{cases}$$

and the input control signal

$$u = \begin{cases} 0, & \text{for } t < 0, \\ 0.1, & \text{for } t \geq 0. \end{cases}$$

The sample time is 0.1s, and the simulation time are 100s seconds.

The simulation structure diagram of the system (43) is show in Fig. 4.

The dynamic response of the system (43) without the state feedback control law (44) is show in Fig. 9.

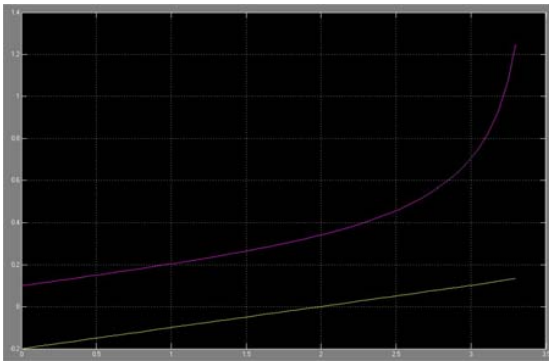

Fig. 9: Dynamic response of the system (43) without the state feedback control law (44).

The dynamic response of the system (43) with the state feedback control law (44) is show in Fig. 10.

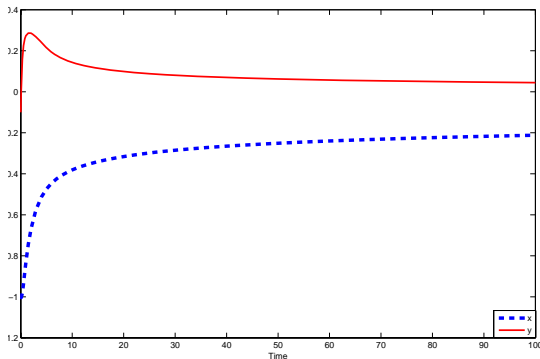

Fig. 10: Dynamic response of the system (43) with the state feedback control law (44).

From the Figure 9, we can know that the opened-loop system respect to the system (43) is unstable, and from the Fig. 10, we can know that the controlled closed-loop system of the system (43) is asymptotically stable. That is, the approach presented in this paper to this sort of systems is effective.

Example 5: Considering the following third order system for *Theorem 5*

$$\begin{cases} \dot{x}_1 = 2x_2 + x_1x_2y + x_1x_2^2y^2, \\ \dot{x}_2 = -2x_1^3 - x_1^2x_2 - x_2^3 + x_1^2y + x_1x_2y + y^5, \\ \dot{y} = u + 4x_1^3x_2 + 2x_1^2x_2 + 2x_2^4 \\ -2x_1^2x_2y - 2x_1x_2^2y + 2x_2y^5. \end{cases} \quad (45)$$

Solution. we can easy know that the function F and G are sufficiently smooth and satisfied condition (24) in this system (47).

Let $y = h(x) = x_1^2 + x_2^2$, and $h \in C^2(r \geq 2)$, $h(0) = 0$, $\frac{\partial h(x)}{\partial x} |_{x=0} = 0$. After substitution $y = x_1^2 + x_2^2$ into the system (45) we see that

$$\begin{cases} \dot{x}_1 = 2x_2 + x_1x_2(x_1^2 + x_2^2) + x_1x_2^2(x_1^2 + x_2^2)^2, \\ \dot{x}_2 = -2x_1^3 - x_1^2x_2 - x_2^3 + x_1^2(x_1^2 + x_2^2) \\ + x_1x_2(x_1^2 + x_2^2) + (x_1^2 + x_2^2)^5, \\ \dot{y} = u + 4x_1^3x_2 + 2x_1^2x_2 + 2x_2^4 \\ -2x_1^2x_2y - 2x_1x_2^2y + 2x_2y^5. \end{cases} \quad (46)$$

Thus, the approximate system of the system (45) is

$$\begin{cases} \dot{x}_1 = 2x_2, \\ \dot{x}_2 = -2x_1^3 - x_1^2x_2 - x_2^3, \\ \dot{y} = u + 4x_1^3x_2 + 2x_1^2x_2 + 2x_2^4 \\ -2x_1^2x_2y - 2x_1x_2^2y + 2x_2y^5. \end{cases} \quad (47)$$

From the approximate system (47), we can known $a = 2$, $a_0 = -2$, so $\lambda_1 a + \lambda_2 a_0 = 0$ at $\lambda_1 = \lambda_2 = 1$, and $a_2 = 0$, $a_1 = -1 < 0$, $a_3 = -1 < 0$, $a_k = a_3 = -1 < 0$.

It's easy to check that the system (45) satisfies the conditions of *Theorem 5*.

Then, there is a state feedback control law

$$u = \begin{bmatrix} 2x_1 & 2x_1 \\ 2x_2 + x_1x_2y + x_1x_2^2y^2 \\ x_1^2y + x_1x_2y + y^5 - 2x_1^3 - x_1^2x_2 - x_2^3 \\ -y + x_1^2 + x_2^2. \end{bmatrix} \quad (48)$$

such that the system (54) is partial asymptotically stabilization in origin.

Simulation. Without loss of generality. Let the initial value of simulation

$$\begin{cases} x_1(0) = 0.5, \\ x_2(0) = 0.5, \\ y(0) = -0.5. \end{cases}$$

and the input control signal

$$u = \begin{cases} 0, & \text{for } t < 0, \\ 0.3, & \text{for } t \geq 0. \end{cases}$$

The sample time is 0.1s, and the simulation time is 100s seconds.

The simulation structure diagram of the system (45) is show in Fig. 11.

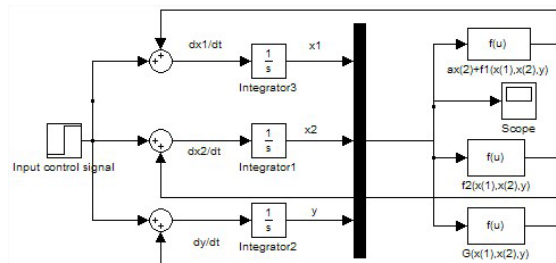

Fig. 11: Simulation structure diagram of the system (45).

The dynamic response of the system (45) without the state feedback control law (46) is show in Fig. 12.

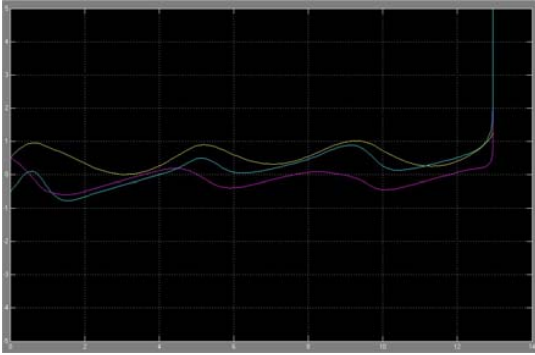

Fig. 12: Dynamic response of the system (45) without the state feedback control law (46).

The dynamic response of the system (45) with the state feedback control law (46) is show in Fig. 13.

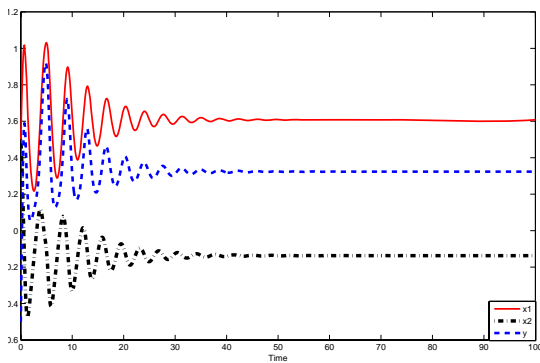

Fig. 13: Dynamic response of the system (39) with the state feedback control law (40).

From the Figure 12, we can know that the opened-loop system respect to the system (45) is unstable, and from the Fig. 13, we can know that the controlled closed-loop system of the system (45) is asymptotically stable. That is, the approach presented in this paper to this sort of systems is effective.

Example 6: Considering the following third order system for *Theorem 6*

$$\begin{cases} \dot{x}_1 = -10x_1^3 + x_1^2x_2 + x_1x_2^3 + x_1^2y + y^4, \\ \dot{x}_2 = -10x_2^5 + 2x_1x_2^4 + 2x_1^3x_2^2 + x_2^3y^3, \\ \dot{y} = u + x_1x_2 + x_1^2x_2^2. \end{cases} \quad (49)$$

Solution. we can easy know that the function F and G are sufficiently smooth and satisfied condition (30) in this system (49).

Without loss of generality. Let $y = h(x) = x_1^2$, and $h \in C^2(r \geq 2)$, $h(0) = 0$, $\frac{\partial h(x)}{\partial x} |_{x=0} = 0$.

After substitution $y = x_1^2$ into the the system (49) we see that

$$\begin{cases} \dot{x}_1 = -10x_1^3 + x_1^2x_2 + x_1x_2^3 + x_1^2(x_1^2) + (x_1^2)^4, \\ \dot{x}_2 = -10x_2^5 + 2x_1x_2^4 + 2x_1^3x_2^2 + x_2^3(x_1^2)^3, \\ \dot{y} = u + x_1x_2 + x_1^2x_2^2. \end{cases} \quad (50)$$

Thus, the approximate system of system (57) is

$$\begin{cases} \dot{x}_1 = -10x_1^3 + x_1^2x_2, \\ \dot{x}_2 = -10x_2^5 + 2x_1x_2^4 + 2x_1^3x_2^2, \\ \dot{y} = u + x_1x_2 + x_1^2x_2^2. \end{cases} \quad (51)$$

From the approximate system (47), we can know $c_0 = -10$, $c_1 = 1$, $c_2 = 0$, $c_3 = 0$ and $d_0 = -10$, $d_1 = 2$, $d_2 = 0$, $d_3 = 3$, $d_4 = 0$, $d_5 = 0$.

It's easy to check that the system (49) satisfies the conditions of *Theorem 6* at $m = 5$.

Then, there is a state feedback control law

$$u = \begin{bmatrix} 2x_1 & 0 \\ -10x_1^3 + x_1^2x_2 + x_1x_2^3 + x_1^2y + y^4 \\ -10x_2^5 + 2x_1x_2^4 + 2x_1^3x_2^2 + x_2^3y^3 \\ -y + x_1^2 \end{bmatrix} \quad (52)$$

such that the system (49) is partial asymptotically stabilization in origin.

Simulation. Without loss of generality. Let the initial value of simulation

$$\begin{cases} x_1(0) = -0.4, \\ x_2(0) = 0.5, \\ y(0) = -0.5. \end{cases}$$

and the input control signal

$$u = \begin{cases} 0, & \text{for } t < 0, \\ 0.05, & \text{for } t \geq 0. \end{cases}$$

The sample time is $0.1s$, and the simulation time are $100s$ seconds.

The simulation structure diagram of the system (49) is show in Fig. 14.

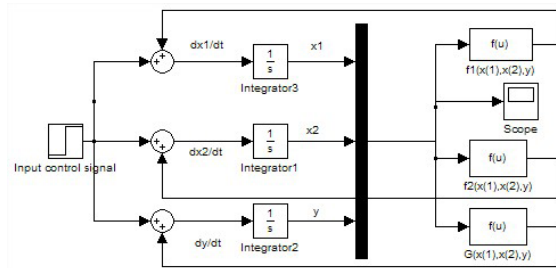

Fig. 14: Simulation structure diagram of the system (49).

The dynamic response of the system (49) without the state feedback control law (50) is show in Fig. 15.

The dynamic response of the system (49) with the state feedback control law (50) is show in Fig. 16.

From the Figure 15, we can know that the opened-loop system respect to the system (49) is unstable, and from the Fig. 16, we can know that the controlled closed-loop system of the system (49) is asymptotically stable. That is, the approach presented in this paper to this sort of systems is effective.

VI. CONCLUSION

This paper considered the problem of the stabilization of a class of nonlinear control systems via center manifold theory. The basic technique has been developed in [15] for affine

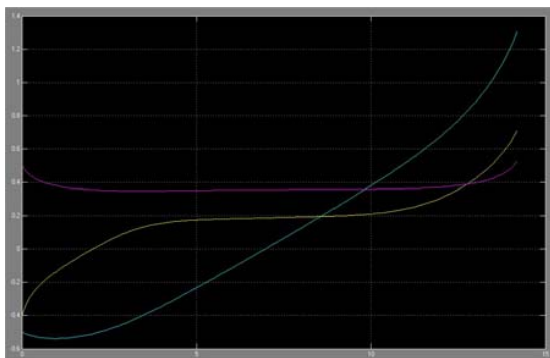

Fig. 15: Dynamic response of the system (49) without the state feedback control law (50)

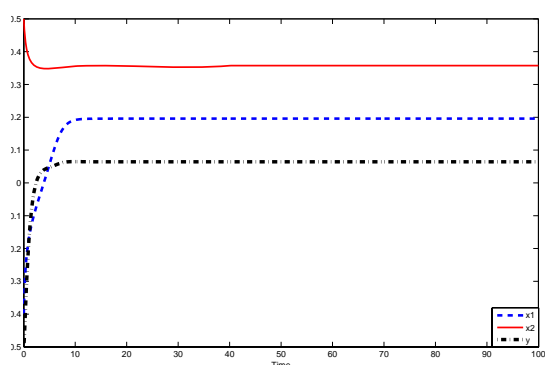

Fig. 16: Dynamic response of the system (49) with the state feedback control law (50)

nonlinear systems with non-minimum phase zero dynamics and in [17] for systems in the affine nonlinear control systems. The especial place of this paper is to reverse designing the state feedback control law from the method of judging system stability with the center manifold theory.

Meanwhile, it was also proved that the design technique of the stabilizer via the center manifold approach, developed in [15], [17], can also be used for a general and large class of nonlinear control systems. First of all, the center manifold theory is applied to discuss the stabilization sufficient condition and design the stabilizing control laws for a class of nonlinear. Secondly, the problem of partial stabilization for a class of plane nonlinear system is discuss using the *lyapunov second method* and the center manifold theory. Thirdly, we investigate specially the problem of the stabilization for a class of homogenous plane nonlinear systems, a class of nonlinear with dual-zero eigenvalues and a class of nonlinear with zero-center using the method of *lyapunov* function with homogenous derivative, specifically, that is, we proposed a new design technique to design the whole approximate center manifold of the approximate system to meet the accuracy requirement of the dynamics on the center manifold.

Furthermore, the approach of this paper can also be extended to the stabilization of cascade systems. The problem of

stabilization for cascade systems required that its subsystems must be stable in previous many references [37]-[40]. However, the approach of this paper does not requires any such constraints from proof process of this paper, just requirements the subsystem of the cascade system is stable under after substitution $y = h(x)$ into its.

We can see that the approach in this paper is significantly expanded compared to pre-existing technique for some nonlinear systems, and the stabilization problem of systems is become more generalized.

At the end of this paper, some examples and simulation results are presented to demonstrate the design procedure and given show that the approach of this paper to this class of nonlinear system is effective and convenient.

VII. OPEN QUESTION

In this paper, there are still many problems remain to be dissolved.

Question 1. There are two kinds of circumstances which still has not been discussed for *Theorems 3-4*.

(i) $a_j > 0$,

(ii) $a_j < 0$, m and j are evens.

So we must present the generally method of stabilization in the future.

Question 2. The dynamic response is slow in Fig. 10 for the *Example 4*, we must reduce system damping such that its rapid response. So we must present the generally method of stabilization in the future.

Question 3. The dynamic response is concussive in Fig. 13 for the *Example 5* before stable, we must increase system damping such that its reposeful response, meanwhile, we have to ensure that its rapid response. So we must present the generally method of stabilization for this sort of system in the future.

Question 4. From main results of this paper, we can know that we should choose $y = h(x)$. In order to as possible that system stabilization, we must choose proper $y = h(x)$. If we can not find proper $y = h(x)$, then we may be mistaken that the system can't stabilization. However, the generally method of selection $y = h(x)$ is not presented in this paper. So we must present the generally method of selection $y = h(x)$ in the future.

So it still needs to be further research based on analysis of this paper.

ACKNOWLEDGMENT

The authors would like to thank the referee for his/her help. In addition, the authors would like to expressing their sincere appreciation to Professor Heng-You Lan and Associate professor Gong-Quan Tan for some valuable suggestions toward achieving work of this paper.

REFERENCES

- [1] A. Bacciotti, "Local stabilization of nonlinear systems," in *Ser. Adv. Math. Appl. Sci.*, vol. 8, River Edge, NJ: World Scientific, 1992.
- [2] J. H. Fu, "Lyapunov functions and stability criteria for nonlinear systems with multiple critical eigenvalues," *Mathematics of Control, Signals, and Systems*, no. 7, pp. 255-278, 1994.

- [3] E. D. Sontag, "Feedback stabilization of nonlinear systems," in *Robust Control of Linear Systems and Nonlinear Control*, vol. 4, M. A. Kaashoek, J. H. van Schuppen, and A. C. M. Ran, Ed. Boston, MA: Birkhauser, 1990, Progress in Systems and Control Theory Series, pp. 61-81.
- [4] H. Hermes, "Asymptotically stabilizing feedback controls," *Journal of Differential Equations*, Vol. XX, no. 92, pp. 76-89, Apr. 1991.
- [5] H. Hermes, "Resonance and feedback stabilization," in *Proc. IFAC Nonlinear Control Systems Design Symp. (NOLCOS 95)*, Tahoe City, NV, 1997, pp. 47-52.
- [6] W. P. Dayawansa, "Recent advances in the stabilization of nonlinear systems for low-dimensional systems," in *Proc. IFAC Nonlinear Control Systems Design Symp. (NOLCOS 92)*, M. Fliess, Ed., Bordeaux, France, 1992, pp. 1-8.
- [7] A. Bacciotti, P. Boieri, and L. Mazzi, "Linear stabilization of nonlinear cascade systems," *Mathematics of Control, Signals, and Systems*, Vol. 6, pp. 146-165, Jun. 1993.
- [8] D. Aeyels, "Stabilization of a class of non-linear systems by a smooth feedback control," *Systems & Control Letters*, Vol. 5, pp. 289-294, Apr. 1985.
- [9] J. Carr, *Applications of Center Manifold Theory*, New York: Springer-Verlag, 1981.
- [10] H. K. Khalil, *Nonlinear Systems*, Second edition, Prentice Hall, New Jersey, 1996, ch. 4.
- [11] A. Isidori, *Nonlinear Control Systems*, Third edition, London: Springer-Verlag, 1995, Appendix B. 1.
- [12] S. Behtash and D. Dastry, "Stabilization of non-linear systems with uncontrollable linearization," *IEEE Transactions on Automatic Control*, Vol. 33, pp. 585-590, Jun. 1988.
- [13] R. Sepulchre and D. Aeyels, "Homogeneous Lyapunov functions and necessary conditions for stabilization," *Mathematics of Control, Signals, and Systems*, vol. 9, pp. 34-58, 1996.
- [14] D. Cheng, "Stabilization via polynomial Lyapunov function," in *W. Kang, M. Xiao, C. Borges Ed. New Trends in Nonlinear Dynamics and Control*, Springer, Berlin, 2003, pp. 161-173.
- [15] D. Cheng and C. Martin, "Stabilization of Nonlinear Systems via Designed Center Manifold," *IEEE Transactions on Automatic Control*, Vol. 46, pp. 1372-1383, Sep. 2001.
- [16] D. Cheng, "Stabilization of a class of nonlinear non-minimum phase systems," *Asian Journal of Control*, Vol. 2, pp. 132-139, Jun. 2000.
- [17] D. Cheng and Y. Guo, "Stabilization of nonlinear systems via the center manifold approach," *Systems & Control Letters*, Vol. 57, pp. 511-518, Jun. 2008.
- [18] D. Liaw and C. Lee, "Stabilization of Nonlinear Critical Systems by Center Manifold Approach," in *Conf. Rec. 2005 IEEE International Conference On Systems & Signals*, pp. 610-613.
- [19] D. CHENG, Q. HU and H. QIN, "Feedback diagonal canonical form and its application to stabilization of nonlinear systems," *Science in China Series F: Information Sciences*, Vol. 48, pp. 201-210, Apr. 2005.
- [20] C. Juan and A. Manuel, "Passivity based stabilization of non-minimum phase nonlinear systems," *Kybernetika*, Vol. 45, pp. 417-426, Jun. 2009.
- [21] F. Amato, C. Cosentino, and A. Merola, "Sufficient conditions for finite-time stability and stabilization of nonlinear quadratic systems," *IEEE Transactions on Automatic Control*, Vol. 55, pp. 430-434, Feb. 2010.
- [22] J. Tsiniias, "Remarks on asymptotic controllability and sampled-data feedback stabilization for autonomous systems," *IEEE Transactions on Automatic Control*, Vol. 55, pp. 721-726, March 2010.
- [23] K. Kalsi, J. M. Lian, and S. H. Zak, "Decentralized Dynamic Output Feedback Control of Nonlinear Interconnected Systems," *IEEE Transactions on Automatic Control*, Vol. 55, pp. 1964-1970, Aug. 2010.
- [24] B. B. Sharma, and I. N. Kar, "Contraction theory-based recursive design of stabilising controller for a class of non-linear systems," *IET Control Theory & Applications*, Vol. 4, pp. 1005-1018, June 2010.
- [25] M. S. Koo, H. L. Choi, and J. T. Lim, "Global regulation of a class of uncertain nonlinear systems by switching adaptive controller," *IEEE Transactions on Automatic Control*, Vol. 55, pp. 2822-2827, Dec. 2010.
- [26] W. Li, Y. Jing, and S. Zhang, "Decentralised stabilisation of a class of large-scale high-order stochastic non-linear systems," *IET Control Theory & Applications*, Vol. 4, pp. 2441-2453, Nov. 2010.
- [27] Z. Zhang, S. Xu, and Y. Chu, "Adaptive stabilisation for a class of non-linear state time-varying delay systems with unknown time-delay bound," *IET Control Theory & Applications*, Vol. 4, pp. 1905-1913, Oct. 2010.
- [28] M. S. Mahmoud, and Y. Xia, "New stabilisation schemes for discrete delay systems with uncertain non-linear perturbations," *IET Control Theory & Applications*, Vol. 4, pp. 2937-2946, Dec. 2010.
- [29] X. Cai, Z. Han, and J. Huang, "Stabilisation for a class of non-linear systems with uncertain parameter based on centre manifold," *IET Control Theory & Applications*, Vol. 4, pp. 1558-1568, Sep. 2010.
- [30] Z. T. Ding, "Global output feedback stabilisation of a class of nonlinear systems with unstable zero dynamics," in *2010 American Control Conference*, pp. 4241-4246.
- [31] H. S. Wu, "Adaptive robust stabilization for a class of uncertain nonlinear systems with external disturbances," in *36th Annual Conference of the IEEE Industrial Electronics Society*, Glendale, AZ, USA, 2010, pp. 53-58.
- [32] C. T. Chen, *Linear System Theory and Design*, Holt, Rinehart and Winston, New York, 1984.
- [33] B. Hamzi, W. Kang, and A. J. Krener, "Control of center manifolds," in *the 42nd IEEE Conference on Decision & Control*, Maui, Hawaii, USA, Dec. 2003, pp. 2065-2070.
- [34] D. C. Liaw, *Feedback stabilization via center manifold reduction with application to tethered satellites*, Ph. D. Dissertation. University of Maryland, 1990.
- [35] C. A. Schwartz and A. Yan, "Systematic construction of Lyapunov function for nonlinear systems in critical cases", in *Proceedings of the 34th IEEE Conference on Decision and Control*, New Orleans, LA, 1995, pp. 3779-3784.
- [36] M. B. William, *An Introduction to Differentiable Manifolds and Riemannian Geometry*, Singapore: Elsevier, 1986.
- [37] E. Panteley, and A. Loria, "Growth rate conditions for uniform asymptotic stability of cascaded time-varying systems," *Automatic*, Vol. 42, pp. 453-460, Sep. 2001.
- [38] R. Sepulchre, M. Arcak, and A. R. Teel "Trading the stability of finite zeros for global stabilization of nonlinear cascade systems," *IEEE Transactions on Automatic Control*, Vol. 47, pp. 521-525, Mar. 2002.
- [39] S. H. Li, and Y. P. Tian "Finite-time stability of cascaded time-varying systems," *International Journal of Control*, Vol. 80, pp. 646-657, Apr. 2007.
- [40] S. H. Ding, S. H. Li, and Q. Li "Globally uniform stability of a class of continuous cascaded systems," *Acta Automatic Sinica*, Vol. 34, pp. 1268-1274, Oct. 2008.