

Wireless Sensor Networks for Water Quality Monitoring: Prototype Design

Cesar Eduardo Hernández Curiel, Victor Hugo Benítez Baltazar, Jesús Horacio Pacheco Ramírez

Abstract—This paper is devoted to present the advances in the design of a prototype that is able to supervise the complex behavior of water quality parameters such as pH and temperature, via a real-time monitoring system. The current water quality tests that are performed in government water quality institutions in Mexico are carried out in problematic locations and they require taking manual samples. The water samples are then taken to the institution laboratory for examination. In order to automate this process, a water quality monitoring system based on wireless sensor networks is proposed. The system consists of a sensor node which contains one pH sensor, one temperature sensor, a microcontroller, and a ZigBee radio, and a base station composed by a ZigBee radio and a PC. The progress in this investigation shows the development of a water quality monitoring system. Due to recent events that affected water quality in Mexico, the main motivation of this study is to address water quality monitoring systems, so in the near future, a more robust, affordable, and reliable system can be deployed.

Keywords—pH measurement, water quality monitoring, wireless sensor networks, ZigBee.

I. INTRODUCTION

THE necessity to detect changes that occur in the environment either by natural sources or human intervention has drastically increased in the last 50 years [1]. When it comes to water quality, it is necessary to describe the condition that it has, its chemical, physical and biological characteristics needs to be included. Depending on the purpose of water, the quality standards vary. For instance, poor water quality could be a risk for both, human and ecosystem health [2].

A. Water Quality

Water quality requires to be continuously monitored. The International Organization for Standardization (ISO) defines water monitoring as the programmed process of sampling, measurement and subsequent register of several water characteristics, normally with the purpose of evaluating specific goals [3]. When monitoring is done with the purpose of creating a response or reaction plan, goals and objectives of the monitoring plan need to be established. Goals are typically more wide and strategic while objectives are more specific and quantifiable [4]. Water is essential for life, and the satisfactory, adequate, safe, and accessible supply should be

available for everyone. The improvement of the access to the water supply can result in benefits for human health. Any effort required to ensure that water is as safe as useable needs to be taken into action [5]. Water quality monitoring can be used for several purposes. One of them is to identify that the water is being used for its designated purpose. Professionals evaluate water quality comparing chemical pollutants concentrations found in streams with the standard criteria of the location, this with the goal of judging if water streams are achieving its designated uses [6]. Another purpose of water quality monitoring is to identify pollutants and its sources. Furthermore, chemical components that are properly monitored (in real time and with consistent methods) can be analyzed to detect tendencies over time. Lastly, water monitoring can be used to detect deterioration. Finding excessive levels of one or more chemicals, serve as an early warning of potential contamination problems [6].

Agriculture is where water is mostly used in Mexico, primarily for crops irrigation. The superficial area for agriculture production was 30.22 million hectares in 2007, according to the VII agriculture, livestock and forest Census [7]. With the purpose of evaluating water quality in Mexico, a Water Quality Index (WQI) was used for several years. This WQI encompasses 18 chemical and physical parameters such as biochemical oxygen demand, dissolved oxygen, grease, oil, color, pH, among others. The WQI indicates the water contamination degree to the date that was measured and is represented as a percentage of pure water; therefore, highly contaminated water will have a WQI close to 0%. The index was developed according to two stages: the first one consists in creating a rating scale according to the many uses that water will have. The second involves the development of a rating scale for each parameter, in a way that a correlation analysis between the different parameters and their influence in the contamination impact can be performed. The organization that performs the WQI analysis in Mexico is the National Water Commission (NWC). Through the National Water Network, the NWC has 1,815 sites distributed throughout the country. The physicochemical and microbiological tests are held in the National Laboratory Network, which consists of 13 laboratories in 15 basin organizations and local addresses. According to the monitoring plan, these laboratories require taking manual samples at certain intervals of time [8].

Despite these previous measures, several disasters due to water contamination have occurred in Mexico. These events had an impact in both human and ecosystems health. One event was the contamination by fecal matter in the Cajititlán lagoon, where the Forensic Sciences Institute of Jalisco

Cesar Eduardo Hernández Curiel is with Universidad de Sonora, Hermosillo, SON 83000 México (e-mail: cesarcuriel@live.com).

Victor Hugo Benítez Baltazar and Jesús Horacio Pacheco Ramírez are with Universidad de Sonora, Department of Industrial Engineering, Hermosillo, SON 83000 México, (e-mail: vbenitez@industrial.uson.mx, jpacheco@industrial.uson.mx).

determined that the death of 4 million tons of fish was because the water had six times the fecal matter index that is permitted [9]. Another event happened in Sonora, Mexico where the contamination of water wells by the spilling of copper sulfate affected 17.6 Km of the Tinajas River, 64 Km of the Bacanuchi River, and 190 Km of the Sonora river [10].

B. pH Measurement

The pH value is used to determine water quality. It is defined as the negative logarithm of the hydrogen ion and can be utilized to measure the balance of acids and bases [11]. Temperature affects the measurement. The effects of temperature can be divided into two main categories: temperature effects that diminish the accuracy and speed of response of the electrode and the temperature coefficient of variation effects on the material being measured by the sensor, whether it be a calibration buffer or a sample [12].

There are several technologies for measuring pH, the most common is the pH electrode. The pH measurement is comprised of two half-cell potentials. One half-cell is the pH sensitive glass measuring electrode and the other is the reference electrode. Just as the two half cells potentials of a battery are required to complete a circuit so does a pH sensor [13]. Another method is the use of indicators and colorimeters. Indicators are materials specifically designed to change color when they are exposed to different pH levels. The colorimeter is a device that utilizes a container filled with a determined volume of sample to which a reagent is added. As the reagent is added, a color change takes place. The color of this solution is then compared to a color wheel or spectral standard to interpolate the pH value [13].

C. ZigBee

The ZigBee protocol is a wireless technology that was designed as a global and open standard, with the purpose of addressing the needs of low-cost and low-power consumption in machine to machine (M2M) networks. ZigBee works in the IEEE 802.15.4 specification and uses the unlicensed bands including 2.4GHz, 900 MHz, and 868 MHz. Some features of this protocol include support for multiple network topology, low work cycles, low latency, up to 65, 000 nodes per network, among others [14].

One of the key components of the protocol is the ability to support mesh networks. In this type of networks, the nodes are interconnected each other in order to form multiple paths. They also have the capability of self-discovering. Besides, when a node leaves the network, mesh topology allows the nodes to reconfigure their routes based in a new network structure. This provides stability in changing conditions or failure in individual nodes [15].

D. Smart Sensors

A smart sensor is defined as the combination of a sensor, signal conditioning, embedded algorithms, and a digital interface [16]. Another definition is that a smart sensor is a system in which a sensor and an electronic interface are interconnected. It can consist of a single chip, like the case of imaging sensors and temperature ones [17]. Smart sensors

acquire information of a non-electrical source and transform it into a useful output. Errors that occur in the processing and conversion steps affect the performance and reliability of the system. Therefore, it is highly important to determine the magnitude of these errors. This process is called calibration [18].

E. Previous Research

In [19] the design of a wireless environmental monitoring system based on sensor networks was developed. The system consists of 3 parts: data monitoring nodes, base station, and a remote monitoring system. The nodes collect pH and temperature parameters. The system is also capable of using linearization and temperature compensation, data packaging, collected data memorizing and routing to base station. These data are transported to a remote monitoring center through a GPRS network. The remote monitoring center analyzes the data and generates alarms for emergencies like water pollution or sudden changes in water parameters. The system shows useful characteristics, like large network capacity, low power consumption, and minor environmental effect.

In [20], a similar project was developed. In contrast with the previous one, the hardware elements of the system had an affordable cost. The system monitors water quality through the parameters of pH, temperature, dissolved oxygen, and conductivity. The data is transferred by GPRS to a web portal and mobile applications.

In this research, we will use a similar approach to that used in [20]. The sensors that are going to be used are from Atlas Scientific and the microcontroller technology is going to be based on the Arduino environment. The main difference is that the system that is being developed will transfer the data from nodes to a nearby station for processing. Furthermore, with the advances in the developing of a prototype, this research will propose an in-situ water quality monitoring floating structure.

II. METHODOLOGY

The system architecture is shown in Fig. 1. The system aims to develop a wireless monitoring system of water quality in a certain area. The system will consist in individual nodes, which are connected to a base station.

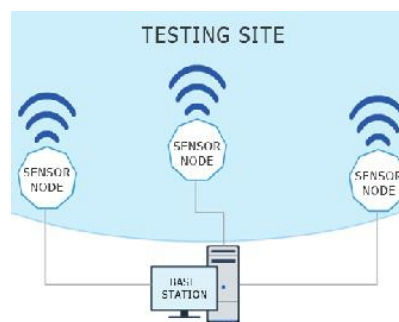

Fig. 1 System architecture

The project consists in 3 stages of development for two hardware prototypes as is shown in Fig. 2. The first prototype

consists in the development of the smart sensor node system. The second prototype corresponds to the development of both hardware and software for the base station.

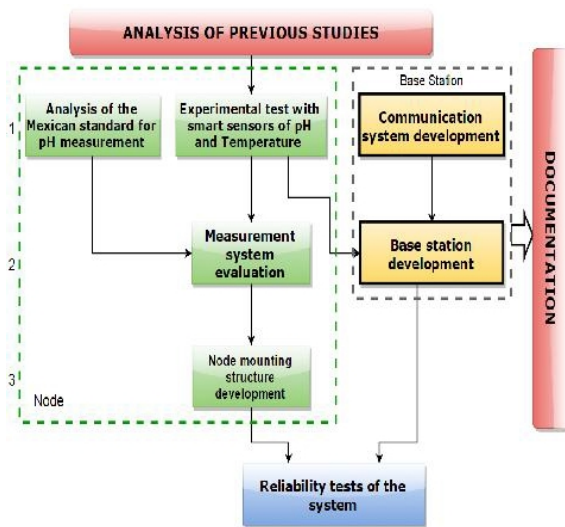

Fig. 2 Methodology approach

A. First Stage

- **Detailed analysis of the Mexican standard for pH measurement.** Because the proposed measurement system is not normalized, the criteria of the Mexican standard needs to be analyzed with respect to its applications, restrictions, and implications.
- **Experimental test with smart sensors.** Development of a low cost, low energy consumption system that has the capability of measuring pH and temperature. The data that comes from this system needs to be reliable in the measurement range of the device.
- **Development of the communication system.** Integrates the measurement system with a wireless module. The system will use the ZigBee protocol and each node will have the possibility of interacting with the microcontroller unit to send data through the wireless sensor network.

B. Second Stage

- **Measurement system evaluation.** Perform an evaluation of the system through the ANOVA method considering 3 temperatures values.
- **Calibration of the system.** With the help of a metrology laboratory, a commercial pH measurement system needs to be used to compare data and therefore, calibrate the system.
- **Development of the base station.** The receiving system will be a radio module with a serial interface for the computer. The software system will be developed in Python programming language for its versatility and its powerful tools for communication. The software shall have the possibility of usage in either Windows or Linux operating systems.

C. Third Stage

- **The design of the smart node mounting structure.** Design a structure capable of assuring the safety of the system and its components. The structure also requires to be deployed in-situ. Propose several design alternatives where the space distribution of the elements of the system is analyzed.

D. Fourth Stage

- **Implement a reliability test of the reception of the data.** For this test, the software XCTU from Digi will be used to analyze range along with the difference between data sent and data received. The test will consist in the examination of the packet loss with the radio at its maximum range. The radio will be tested in both outdoor and indoor environments.

III. PROTOTYPE DESIGN

The creation of the first prototype was developed with the goal of testing the variance of the system and reliability of the data. Design aspects were not taken into account. In Fig. 3, the whole system architecture is shown.

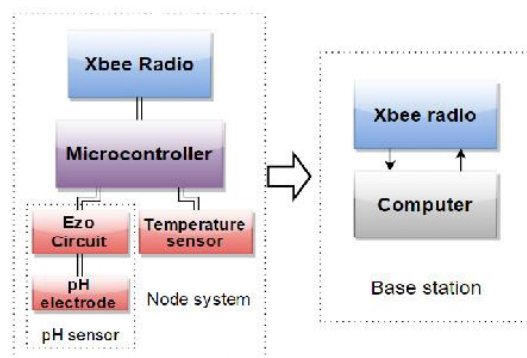

Fig. 3 Hardware Architecture

The system consists of a node system and a base station; these two elements send and receive data between each other. The node system transmits pH and temperature data over the wireless network through ZigBee protocol. The base station receives this data and transfers it to a computer through a USB port. The individual elements of the whole system are described as follows:

1. **Microcontroller.** An Arduino Uno IDE that is based on the ATmega328p chip was used. Some of the features are 14 digital I/O (6 of them can be used as PWM), 6 analogic inputs, a 16MHz crystal oscillator, energy connector and a reset button [21].
2. **pH sensor.** AtlasScientific smart pH sensor and EZO circuit sends data with the highest level of precision and stability. The sensor has the capacity of delivering readings from 0.001 to 14.000 in the pH scale with a +/- 0.02 of accuracy. Temperature dependent or independent readings can be achieved. The sensor also has a flexible calibration protocol and a continuous or single reading

- mode [22].
3. Temperature sensor. The Dallas Semiconductors DS18B20 has 9 to 12-bit temperature readings. The sensor communicates through the One-Wire interface; this allows the possibility of multiple sensors in only one port. The reading ranges from -55°C to 125°C with an accuracy of +/- 0.5°C [23].
 4. Wireless communication. Xbee ZB S2 modules, which are based on the ZigBee protocol, were selected for the prototype. These modules have the ability of cost-effective wireless communication for a wide range of electronic devices. Xbee modules are ideal for applications in the energy and control sectors. The communication range is up to 40 meters in urban environments and 120 meters in open spaces. The serial interface supports up to 1Mb/s and the RF data transmission is 250 Kbps. Voltage requirements are in the range of 2.1 V to 3.6 V with a transmit power of 3 dBm [24].
 5. Computer. For data visualization, software (interface, IDE) is being developed in Python programming language. The computer will also have the receiving module which consists of an Xbee Radio and an interface to connect to the PC. The software aims to address the analysis of data through prediction statistics and event detection.

Fig. 4 illustrates the measurement routine of the node system. Each stage has its own interaction between the hardware elements of the node.

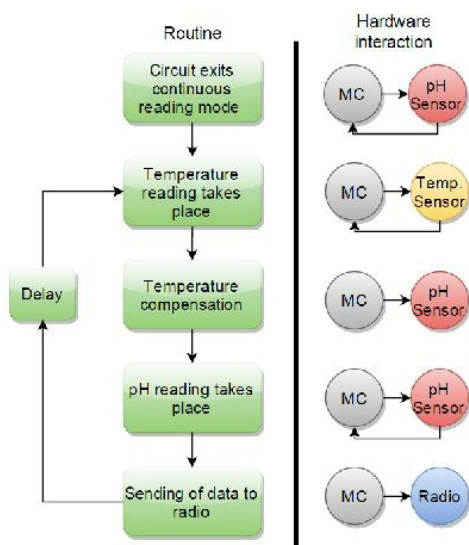

Fig. 4 Program Routine

1. The AtlasScientific smart pH Sensor has its default configuration on continuous reading mode [22]. The program needs to take the system out of continuous mode, so it can compensate temperature and take a reading every time the MC asks for it.
2. Temperature reading. The MC sends a command to the address that has the One-Wire interface with the

temperature sensor. The sensor responds with a reading in Celsius and the MC stores it in a variable for future use.

3. Temperature compensation. The MC sends the value of the temperature in ASCII form through the I²C protocol. The pH circuit receives this value and responds with an “OK” ASCII response.
4. pH Reading. The MC sends a command to the circuit to take a pH reading, the circuit responds and then the MC stores this value in another variable.
5. Communication of data. Both values, pH and temperature, are sent through the serial port of the MC to the Xbee radio.
6. Delay. Due to the stages taking a small time to process, a delay was added. This delay can be established according to the monitoring strategy that is planned.

A temporal mounting structure was also created to support the hardware elements. The structure is able to mount and unmount the elements with ease, so four supports that matched Arduino mounting holes were designed. The design was 3D printed with PLA material in a MakerBot 3D printer. Fig. 5 depicts a 3-D representation of each element in the node system.

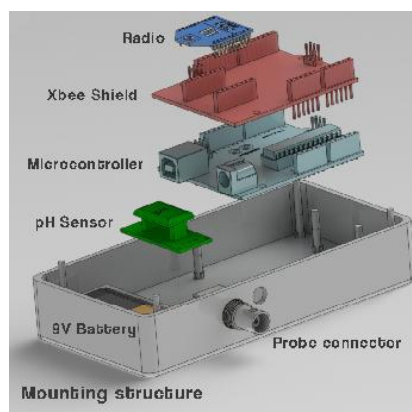

Fig. 5 3D representation

The structure was also developed to test the variance of the measurements with all the hardware elements installed. Fig. 6 shows the system with all the elements installed on it. A 9V battery was added to provide the system with a temporary energy source.

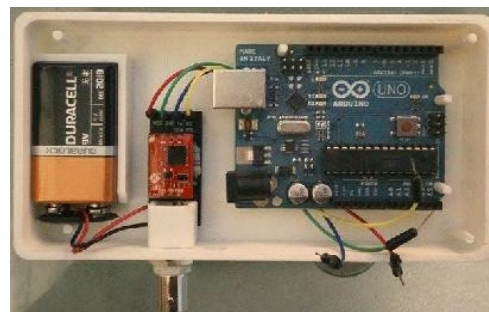

Fig. 6 Physical Structure and elements

IV. FUTURE WORK

Once the reliability tests take place, a new system will substitute the temporary structure. The system is shown in Fig. 7. The system consists of a cylindrical container made of acrylic plastic in which the power and control modules are installed. The power module will consist of a battery pack specially designed for the system. The control module will be a custom PCB with the ATmega328p and the Xbee radio, both with their corresponding peripherals. Two caps will protect the system from outside humidity.

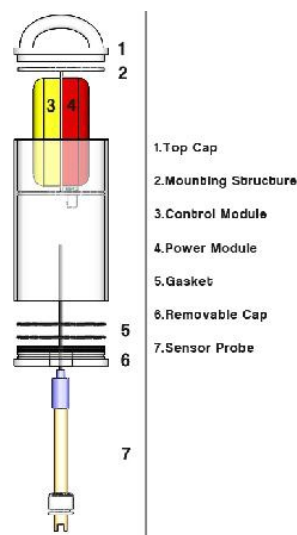

Fig. 7 Cylindrical Acrylic Structure

The top cap will be fixed in the cylindrical tube whereas the removable cap will give the possibility of the removal of the internal mounting structure for its programming and testing. This cap will have two rubber gaskets to seal the system properly. Finally, an adapter will be installed to isolate the probe from the other parts of the system. The primary goal of this system is the easy installation on the in-situ floating structure that will be proposed in the future.

V. CONCLUSIONS

Currently, the monitoring processes of natural resources and the environment are of high importance. The main advantage of real-time water quality monitoring is the fast response to unusual events that may occur. If not detected with anticipation, these events could lead to harmful consequences to human and environmental health. Our main motivation is to develop a system that in the near future can be deployed in the current problematic locations in Mexico.

Advances in technology forces organizations to innovate their processes, especially those related to assuring water quality. Current monitoring systems offered by government or private organizations in Mexico have the necessity of the implementations of new technologies. The primary goal of this research work is to reduce the time and cost of the pH and temperature test of water quality that is being done in

Mexico's polluted sites.

With a prototype designed with affordable and easy to use elements, researchers can acquire the knowledge for future robust implementations. The advances in this investigation are helping in developing this technology.

REFERENCES

- [1] Sánchez, O. (editor). *Perspectivas sobre conservación de ecosistemas acuáticos en México (Spanish)*. National Institute of Ecology. México, 2007.
- [2] Florida Keys National Marine Sanctuary, *Water Quality*. Available at: <http://floridakeys.noaa.gov/ocean/waterquality.html>, 2011 (Accessed September 2015).
- [3] Bartram, J, Ballance R. *Water Quality Monitoring: A Practical Guide to the Design and Implementation of Freshwater Quality Studies and Monitoring Programs*. London UK: World Health Organization. 348 1996.
- [4] Roni, P. (editor), and E. Quimby (technical editor). *Monitoring stream and watershed restoration*. American Fisheries Society, Bethesda, Maryland, 2005.
- [5] World Health Organization. *Guidelines for drinking water quality 4th ed.* Geneva, Switzerland, 2011.
- [6] World Meteorological Organization (WMO). *Planning of Water-Quality Monitoring Systems*. Available at: http://www.wmo.int/pages/prog/hwrp/publications/Technical_report_series/TR-No3water_quality_monitoring_systems.pdf Geneva Switzerland, 2013 (Accessed October 2015).
- [7] International Commission of Irrigation and Drainage (ICID). *México Profile* Available at: http://www.icid.org/cp_mexico.html (Accessed September 2015).
- [8] National Water Commission. 2010. *Statistics on Water in Mexico. México*, 2010.
- [9] Proceso Magazine. *Detectan alta contaminación de organismos fecales en la laguna de Cajititlan (Spanish)*. Available at: <http://www.proceso.com.mx/?p=381778> (Accessed September 2015).
- [10] Cisneros R. *Derrame en el río Sonora: lo que sabemos y lo que no sobre el caso (Spanish)*, Available at: <http://mexico.cnn.com/nacional/2014/08/28/derrame-en-el-rio-sonora-lo-que-sabemos-y-lo-que-no-sobre-el-caso> (Accessed October 2015).
- [11] World Health Organization. *Water and health*, Available at http://www.who.int/water_sanitation_health/mdg1/en, 2013 (Accessed September 2015).
- [12] Barron J., Ashton C. and Geary L. *The effects of temperature on pH measurement*. 57th Annual Meeting of the International Society of Electrochemistry. Edinburgh. 2006.
- [13] Hach Company. *What is pH and how is it measured? A technical handbook for industry*. Hach Company U.S.A., 2010.
- [14] Digi International Inc. *XBee and XBee-PRO ZigBee RF Modules*. Available at: <http://www.digi.com/products/xbee-rf-solutions/modules/xbee-zigbee#specifications> (Accessed September 2015).
- [15] Yang, S. *Wireless Sensor Networks (Signals and Communication Technology)*. 1st Edition. Springer, 2014.
- [16] Gervais-Ducouret, S. *Next smart sensors generation*. Sensors Applications Symposium (SAS), 2011 IEEE, vol., no., pp.193-196, 22-24 Feb. 2011.
- [17] Makinwa, K. *Smart Sensor Design*. Smart Sensor Systems, ed: John Wiley & Sons, Ltd, 2014, pp. 1-16.
- [18] Pertjjs, M. *Calibration and Self-Calibration of Smart Sensors*, Smart Sensor Systems, ed: John Wiley & Sons, Ltd, 2014, pp. 17-41.
- [19] Jiang P., Xia H., He Z. & Wang Z., 2009. *Design of Water Environment Monitoring System Based on Wireless Sensor Networks*. MDPI, China.
- [20] Faustine, A., Mvuma, A., Mong, H., Gabriel, M., Tenge, A., Kucel, S. *Wireless sensor networks for water quality monitoring and control within Lake Victoria Basin: Prototype development*. Tanzania, 2014.
- [21] McRoberts, M. *Beginning Arduino*. New York: Apress, 2010.
- [22] AtlasScientific. *EZO TM class embedded pH circuit*. Available at: https://www.atlas-scientific.com/files/datasheets/circuit/pH_EZO_datasheet.pdf (Accessed September 2015).
- [23] SparkFun. *Programmable Resolution 1-Wire® Digital Thermometer*. Available at: <http://cdn.sparkfun.com/datasheets/Sensors/Temp/DS18B20.pdf> (Accessed September 2015).

- [24] Digi International Inc (a). *ZigBee RF Modules Xbee2, Xbeepro2 Xbee Pro S2B*. Available at: http://ftp1.digi.com/support/documentation/90000976_W.pdf (Accessed September 2015).