

# Wind Tunnel Investigation of the Turbulent Flow around the Panorama Giustinelli Building for VAWT Application

M. Raciti Castelli, S. Mogno, S. Giacometti, and E. Benini

**Abstract**—A boundary layer wind tunnel facility has been adopted in order to conduct experimental measurements of the flow field around a model of the Panorama Giustinelli Building, Trieste (Italy). Information on the main flow structures has been obtained by means of flow visualization techniques and has been compared to the numerical predictions of the vortical structures spread on top of the roof, in order to investigate the optimal positioning for a vertical-axis wind energy conversion system, registering a good agreement between experimental measurements and numerical predictions.

**Keywords**—Boundary layer wind tunnel, flow around buildings, atmospheric flow field, vertical-axis wind turbine (VAWT).

## I. INTRODUCTION

RECENT instabilities of world economy, due to the increasing price of carbon-derivative fuels along with the connected socio-political turbulences, have aroused the interest in the production of renewable energy among the most industrialized western nations. In this scenario, the continuous quest for clean energy is now focusing on the local production of electric power, spread in a wide area, so as to cooperate with the big electric power plants positioned in just few specific strategic locations of the countries. One of the most promising resources is wind power associated with local production of clean electric power inside the built environment, such as industrial and residential areas, which has also renewed the interest in vertical-axis wind turbines (VAWTs). As observed by Bahaj et al. [1], such machines have the potential to reduce built environment related CO<sub>2</sub> emissions, coupled with reductions in consumers' electricity costs. Moreover, the produced energy can be fed directly into the grid of the building, determining a reduction of its external energy demand. Some of the specific technology and design issues in the use of wind energy for buildings have been described by several authors: Mertens [2] focused on the design of civil architectures that maximize wind harvest and

examined a set of turbines that provide power for buildings. Stankovic et al. [3] focused on the potential for exploiting wind power in urban areas, identifying three main categories of project, that is: small wind and retrofitting, large-scale stand-alone turbines and building-integrated turbines. Mertens [4] described concentrator effects for wind turbines close to buildings, in order to compensate the lower average wind speeds and higher turbulence levels of the built environment.

Although - in a near future - buildings and wind turbines will probably start to be designed as an integrated system, by now, one very real possibility to achieve commercial success is to simply place wind turbines on the roof of buildings, profiting of the hill effect locally generated. VAWTs seem to be more appropriate than commonly used Horizontal-Axis Wind Turbines (HAWTs), since these kinds of machines do not suffer from the frequent wind direction changes. Moreover, their power output is not conditioned by the operation in turbulent flows, which are typical of the built environment.

## II. THE CASE STUDY

The present work is part of a research project finalized to the installation of a wind energy conversion system (WECS) on top of the Panorama Giustinelli Building, Trieste (Italy). Fig. 1 shows a rendering of the building and the selected position of the turbine mounting point.



Fig. 1 Rendering of the Panorama Giustinelli Building, showing also the selected position for the placement of the WECS

Marco Raciti Castelli is a Research Associate at the Department of Industrial Engineering of the University of Padua, Via Venezia 1, 35131 Padova, Italy (e-mail: marco.raciticastelli@unipd.it).

Stefano Mogno is a M.Sc. Student in Aerospace Engineering at the University of Padua, Via Gradenigo 6/B, 35131 Padova, Italy (e-mail: stefano.mogno@studenti.unipd.it).

Stefano Giacometti is Chief Maintainer at O.Z. S.p.A., Via Monte Bianco 10, 35018 San Martino di Lupari (PD), Italy (e-mail: stefano.giacometti@ozracing.com).

Ernesto Benini is an Associate Professor at the Department of Industrial Engineering of the University of Padua, Via Venezia 1, 35131 Padova, Italy (e-mail: ernesto.benini@unipd.it).

Fig. 2 shows a view of the building site (evidenced by the red square), located in the historical center of Trieste, on the S. Vito hill. As can be clearly seen from Fig. 3, the Panorama Giustinelli site is directly exposed to the wind coming from the Gulf of Trieste, due to the limited obstructions from surrounding buildings.



Fig. 2 View of the building site (evidenced by the red square)



Fig. 3 City view from top of the building, showing the limited obstructions from the conterminous constructions

Some preliminary analyses of the wind potential on top of the Panorama Giustinelli building have already been performed. Raciti Castelli and Benini [5] presented a comparison between the Annual Energy Output (AEO) of two commercial VAWTs for the Panorama Giustinelli site, based on the anemometric data measured by the Piazza Hortis meteorological station, located some 300 meter aside: both a drag-driven and a lift-driven concepts were examined, registering a quite similar AEO due to both the higher aerodynamic performances of the lift-driven device for higher wind speeds (over 8 m/s) and the capability of the drag-driven device to operate also with lower winds. Raciti Castelli and Benini [6] also performed a numerical campaign of analysis of the turbulent flow around the building immersed in an atmospheric boundary layer: the characteristic wind velocity profiles of the building site were reproduced through the use of proper User-Defined Functions (UDFs) for the most probable incoming wind directions and for several reference

mean wind velocities. Finally, through the analysis of the separated flow region on top of the roof, performed by means of a Computational Fluid Dynamics (CFD) commercial code, the best positioning of the VAWT was proposed.

In order to maximize the total efficiency of the wind power generation system, the present work proposes a comparison between the numerical predicted optimal positioning of the WECS determined from [6] and the results of a measurement campaign conducted using a boundary layer wind tunnel facility. In particular, the extension of recirculation bubble on top of the roof, determining a low pressure region characterized by high turbulence and low wind speed, is investigated for the most probable incoming wind direction, corresponding to a wind blowing from NE, as can be seen from Fig. 4, showing the wind rose plot for the city of Trieste from the Piazza Hortis meteorological station.

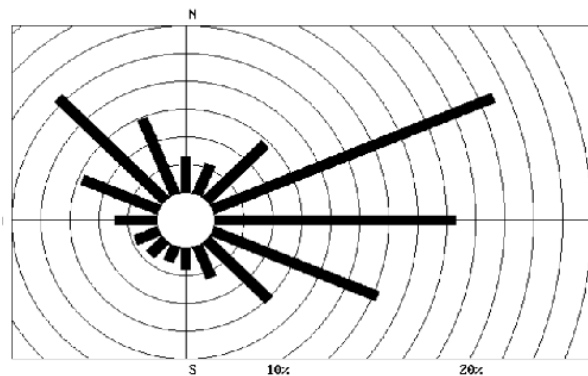

Fig. 4 Wind rose plot for the city of Trieste (from: [7]); as can be clearly seen, the probability of the wind to blow from NE exceeds 20%



Fig. 5 Internal view of the open-circuit wind tunnel facility

### III. THE BOUNDARY LAYER WIND TUNNEL FACILITY

The atmospheric wind tunnel facility of the University of Padua (Italy) was specifically designed for the evaluation of wind potential around city buildings for the installation of micro-wind energy conversion systems (micro-WECS). Current studies focus on basic research of the interaction between turbulent boundary layers and scaled building models. As can be seen from Fig. 5, the facility is composed by a low speed, open circuit wind tunnel of the suction type. It incorporates an air inlet, fitted with honeycomb and meshes, a contraction section and several interchangeable square test sections of 350 x 350 mm, whose length can vary between 900 mm and 2000 mm. The main characteristics of the test facility are summarized in Table I.

TABLE I  
MAIN CHARACTERISTICS OF THE ATMOSPHERIC WIND TUNNEL FACILITY

Denomination	Value
Design flow speed in the test section [m/s]	15
Maximum flow speed in the test section [m/s]	33
Contraction section maximum width [mm]	1000
Contraction section aspect ratio [-]	1
Contraction section length [mm]	2000
Contraction ratio [-]	8.16
Test section width [mm]	350
Test section aspect ratio [-]	1
Test section maximum length [mm]	2000
Diffuser length [mm]	2000
Diffuser angle [°]	5
Fan section diameter [mm]	640

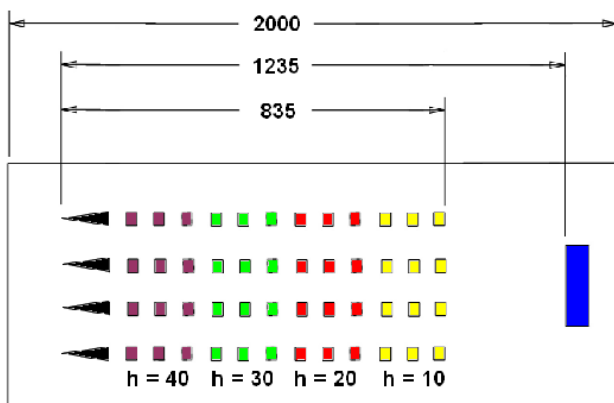

Fig. 6 Schematic top view of the elements of roughness and vorticity generators (in black) for the development of the turbulent boundary layer (from: [8])

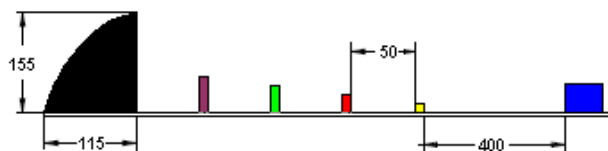

Fig. 7 Schematic side view of the elements of roughness and vorticity generators (in black) for the development of the turbulent boundary layer (from: [8])

The circuit forms an open loop through which air is pumped by means of a 640 mm diameter axial fan, driven by a 2.25 kW AC motor, providing a maximum flow velocity in the test section of 33 m/s. The fan is composed of 7 cambered blades made from sheet metal and the whole unit is rated for a 16.000 m<sup>3</sup>/h flow. A contraction section is located between the settling chamber and the test section: its purpose is both to increase mean velocities at the test section inlet and to reduce inconsistencies in the uniformity of the flow field.

Both lateral and upper glass windows, placed in the test section, allow the visualization of the main flow features during the experiments, while a 5° diffuser is adopted to connect the square end of the test section to the circular fan section, in order to maximize pressure recovery while avoiding boundary layer separation and connected flow unsteadiness.

According to the work of Ozmen et al. [9], a turbulent boundary layer of 150 mm thickness is generated by means of several elements of roughness and vorticity generators, as shown in Figs. 6 and 7. A 40 mm height (1:525) model of the Panorama Giustinelli Building is placed in the central line of the wind tunnel, as shown in Fig. 8, obtaining a turbulence intensity of 12% at the level of model height in reference boundary layer, as described by [9]. The main dimensions of the real building are summarized in Table II.

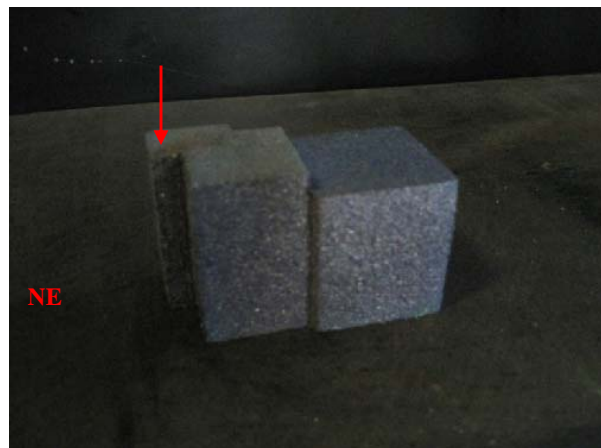

Fig. 8 Scaled (1:525) model of the Via dei Giustinelli Building, the red arrow illustrates the WECS mounting point; the most probable incoming wind direction (NE) is on the left hand-side of the figure

TABLE II  
MAIN DIMENSIONS OF THE PANORAMA GIUSTINELLI BUILDING

Denomination	Value
Building height [m]	21
Building length [m]	34
Building width [m]	18.6

### IV. EXPERIMENTAL RESULTS AND COMPARISON WITH NUMERICAL PREDICTIONS

Fig. 9 shows the main flow features – obtained by means of a smoke generator placed 80 mm upwind with respect to the model – on the vertical plane passing from the WECS

mounting point and oriented from NE to SW, as evidenced in Fig. 10. A recirculation zone on top of the roof and downstream of the building can be clearly seen: this zone should be avoided for a correct wind turbine positioning. As can be observed from the comparison with Fig. 11, representing the computed absolute velocity vectors on top of the roof for a 11 m/s reference wind speed (from: [6]), acceptable agreement can be registered between the experimental flow visualization and the CFD simulation, being the inclination of the separation bubble at the leading edge of the roof similar for both the numerical code and the experimental investigations. The experimental investigation registers also a marked overestimation of the whole separation bubble on top of the building with respect to the predictions of the numerical code, where the separated flow tends to reattach after the initial separation bubble, as evidenced by the green arrow in Fig. 11.

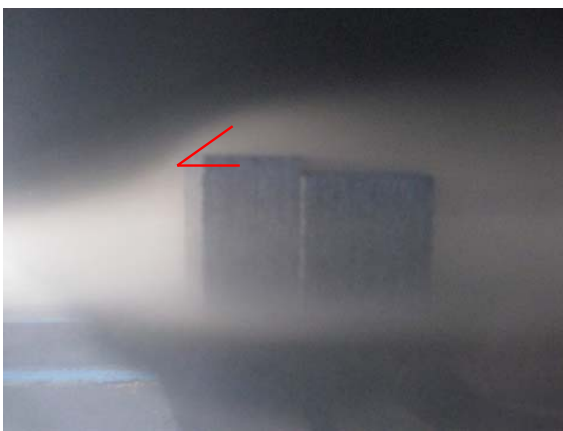

Fig. 9 Main flow features on the vertical plane passing from the WECS mounting point and oriented from NE to SW; the inclination of the separation bubble at the leading edge of the roof is evidenced by the red lines

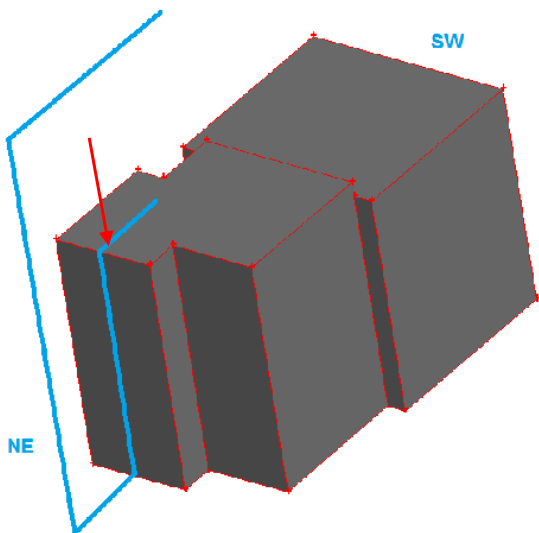

Fig. 10 Visualization of the plane passing from the WECS mounting point (evidenced by the red arrow) and oriented from NE to SW

As can be drawn from Fig. 12, showing an overlap between the main flow features of Fig. 9 and the characteristic dimensions of the Panorama Giustinelli Building, in order to avoid disturbance from the separation bubble on top of the structure, the WECS should be installed so that the lower portion of the rotor is placed at least 4.5 meters above the roof.

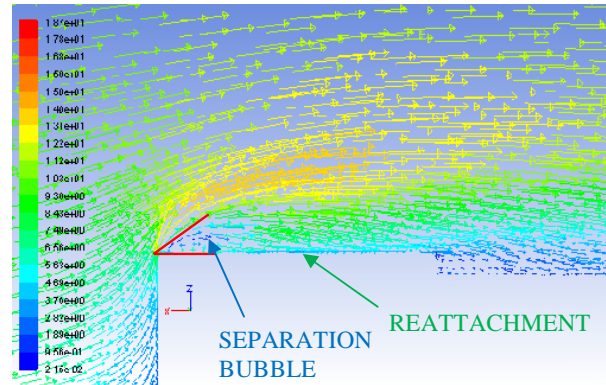

Fig. 11 Absolute velocity vectors [m/s] on the vertical plane passing from the WECS mounting point and oriented from NE to SW, for 11 m/s reference wind velocity (from: [6]); the inclination of the separation bubble (evidenced by the blue arrow) at the leading edge of the roof is evidenced by the red lines, while the reattachment of the flow is illustrated by the green arrow

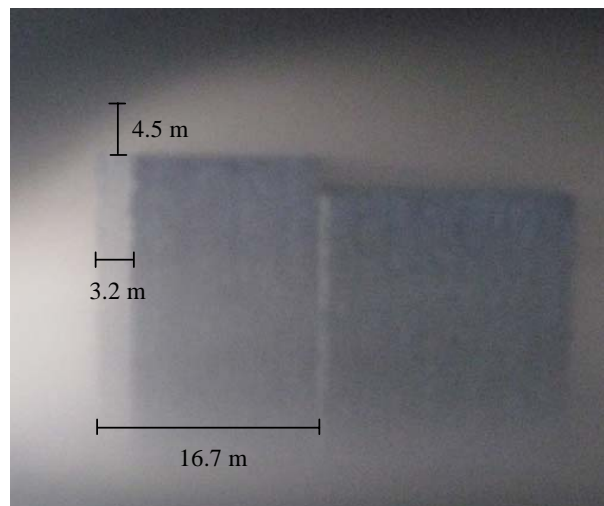

Fig. 12 Overlap between a detail of the main flow features on the vertical plane passing from the WECS mounting point and oriented from NE to SW and the characteristic dimensions of the Panorama Giustinelli Building

#### V. CONCLUSION AND FUTURE WORK

The turbulent flow around a model of the Panorama Giustinelli Building has been investigated using a boundary layer wind tunnel, in order to determine the optimal installation point for a vertical-axis wind turbine to be placed on top of its roof. Information on the main flow structures has been obtained by means of a smoke generator based visualization techniques on the vertical plane passing from the

selected rotor mounting point and oriented from NE to SW, corresponding to the most probable incoming wind direction.

A recirculation zone on top of the roof and downstream of the building has been registered: this zone should be avoided for a correct wind turbine positioning, being characterized by reduced wind speed and high turbulence level.

A comparison between wind tunnel flow visualization and numerical prediction of the turbulent flow on top of the building has also been performed, registering an acceptable accordance as far as the inclination of the separation bubble at the leading edge of the building is concerned, while a marked overestimation of the whole separation bubble has been observed with respect to the predictions of the numerical code.

Further work should consider the direct measurement of the wind potential on top of the building through a complete anemometric campaign, performed by means of an anemometric mast placed on the selected turbine installation position and composed by at least three anemometers and weather vanes placed at different heights with respect to the roof, in order to characterize the turbulent recirculation zone fully.

#### REFERENCES

- [1] A. S. Bahaj, L. Meyers and P. A. B. James, "Urban energy generation: Influence of micro-wind turbine output on electricity consumptions in buildings", *Energy and Buildings*, Vol. 39, Issue 2, February 2007, pp. 154-165.
- [2] S. Mertens, *Wind Energy in the built environment*, Multiscience Publishing, 2006.
- [3] S. Stankovic, N. Campbell and A. Harries, *Urban wind energy*, Earthscan, 2009.
- [4] S. Mertens, "Wind energy in urban areas: Concentrator effects for wind turbines close to buildings", *Refocus*, Vol. 3, Issue 2, March-April 2002, pp. 22-24.
- [5] M. Raciti Castelli and E. Benini, "Comparison between Lift and Drag-Driven VAWT Concepts on Low-Wind Site AEO", *ICAMME 2012: International Conference on Applied Mechanics and Mechanical Engineering*, Venice (Italy), November 28-30, 2011 (in: World Academy of Science, Engineering and Technology, Issue 59 – 2011, pp. 1677-1682).
- [6] M. Raciti Castelli and E. Benini, "Numerical Prediction of the Turbulent Flow over a Flat-Roof Building for VAWT Application", *E-NOVA 2011*, Campus Pinkafeld, Eisenstadt (Austria), November 24-25, 2011.
- [7] [http://www.dst.univ.trieste.it/OM/OM\\_TS.html](http://www.dst.univ.trieste.it/OM/OM_TS.html)
- [8] M. Raciti Castelli, S. Mogno, S. Giacometti and E. Benini, "Development of a Boundary Layer Wind Tunnel Facility for the Physical Modeling of the Atmospheric Flow Field around Buildings", submitted for publication to the *International Journal of Pure and Applied Sciences and Technology*.
- [9] Y. Ozmen, J. P. A. J. van Beeck and E. Baydar, "The Turbulent Flow over Three Dimensional Roof Models Immersed in an Atmospheric Boundary Layer", *COST Action C14*, Von Karman Insitute, Rode-Saint-Genèse (Belgium), May 5-7, 2004.