

# Vector Control of Multimotor Drive

Archana S. Nanoty, and A. R. Chudasama

**Abstract**—Three-phase induction machines are today a standard for industrial electrical drives. Cost, reliability, robustness and maintenance free operation are among the reasons these machines are replacing dc drive systems. The development of power electronics and signal processing systems has eliminated one of the greatest disadvantages of such ac systems, which is the issue of control. With modern techniques of field oriented vector control, the task of variable speed control of induction machines is no longer a disadvantage. The need to increase system performance, particularly when facing limits on the power ratings of power supplies and semiconductors, motivates the use of phase number other than three. In this paper a novel scheme of connecting two, three phase induction motors in parallel fed by two inverters; viz. VSI and CSI and their vector control is presented.

**Keywords**—Field oriented control, multiphase induction motor, power electronics converter.

## I. INTRODUCTION

**A**PPPLICATION of induction motors in continuous duty variable speed drives calls for static inverters of adequate power, generating three phase voltages of variable amplitude and frequency. In that case, indirect frequency conversion methods are appropriate. The indirect frequency changer consists of rectification and inversion. There is a large variety of solution for the inverter and control problem. They are broadly classified depending on the source feeding them: Voltage or Current. i.e Voltage source inverter fed and current source inverter fed induction motor [4]-[5].

**Vector Control:** In vector or field oriented control both the magnitude and phase alignment of vector variables are controlled. The invention of vector control in the beginning of 1970s and the demonstration that an induction motor can be controlled like a separately excited dc motor brought renaissance in the high performance of control of ac drives. Because of dc like performance vector control is also known as “decoupling” orthogonal or trans vector control.

Field orientation is a technique that provides a method of decoupling the two components of stator current: one producing the air-gap flux and the other producing the torque. The principle of field orientation originated in the former West Germany through the work of Blaschke and Hasse (Blaschke 1972; Hasse 1969). A variety of implementation methods have now been developed but these techniques can be broadly classified into two groups: direct control and indirect control.

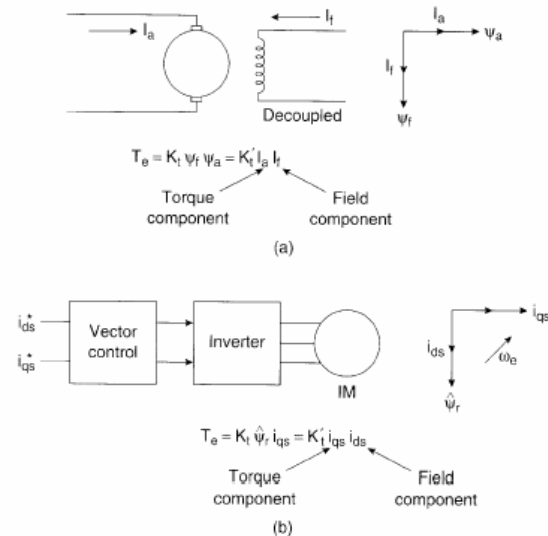

Fig. 1 Principal of field oriented control

Fig. 1 explains the principal of vector control. Here analogy of three phase induction motor with separately excited dc motor is shown. For field oriented control, three phase induction motor is run like a separately excited dc motor. For this a d-q axis model of induction motor is must [2]-[3].

## II. COMPARISON OF VSI AND CSI

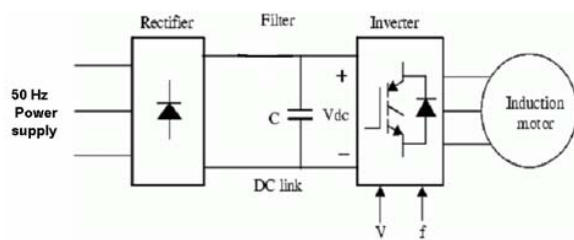

Fig. 2 VSI fed Induction motor

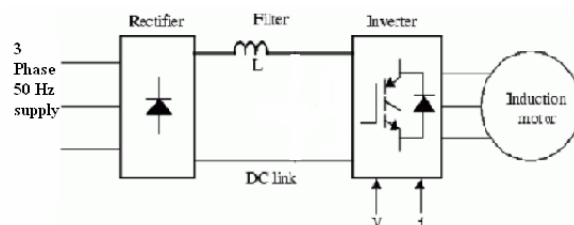

Fig. 3 CSI fed Induction motor

**VSI**

- a) Operates easily at no load.
- b) Normally used where multimachine capability is required.
- c) Asymmetric blocking devices can be used
- d) Less interactive with load
- e) Requires regenerative converter on line side.
- f) Superior efficiency, overall cost and transient response than CSI.
- g) Less rugged and reliable
- h) Good dynamic response as compared to CSI
- i) Open loop volt/hertz is common
- j) Control of PWM VSI is complex

**CSI**

- a) Unable to operate at no load
- b) Multimachine operation is very difficult.
- c) Only symmetric blocking devices can be used.
- d) More interactive with load.
- e) Because of inherent four-quadrant operation extra power circuit is not required.
- f) Inferior efficiency, overall cost and transient response than VSI.
- g) More rugged and reliable.
- h) Sluggish dynamic response compared to VSI
- i) It cannot be used in open loop.
- j) Control is easy.

**III. PROPOSED SCHEME**

The classic vector-control scheme consists of the torque and flux control loops, and motor 1 is supplied from a voltage source inverter and motor 2 is supplied from current source inverter. Although most of the power absorbed by the motor is supplied by the CSI, from the control point of view it is the VSI that constitutes the actuator, and, consequently, the motor can be considered as voltage-controlled. The voltage source characteristic of the tandem converter is decisive with respect to the structure of a vector-control scheme. For the vector control of induction motors, the rotor-field orientation has the advantage of easy decoupling of the torque and flux controls. The two motors are controlled using Tandem converter i.e. One motor fed by VSI and the other fed by CSI [1].

The present research is directed to the formulation and experimental verification of parameter compensation schemes; in the vector controlled induction motor drives. Voltage source inverters which dominate modern adjustable speed ac drives are not free from certain disadvantages. In particular the high switching rate needed for good quality of the current fed to the motor causes losses, electromagnetic interference etc. The extent of these undesirable phenomena depends on the magnitude of currents switched in VSI. CSI fed drives are also used but it has a drawback of not operating in open loop.

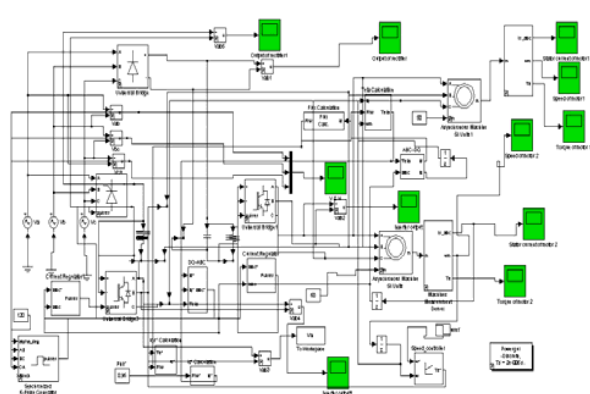

Fig. 4 Vector Control of Two, Three phase Induction motor

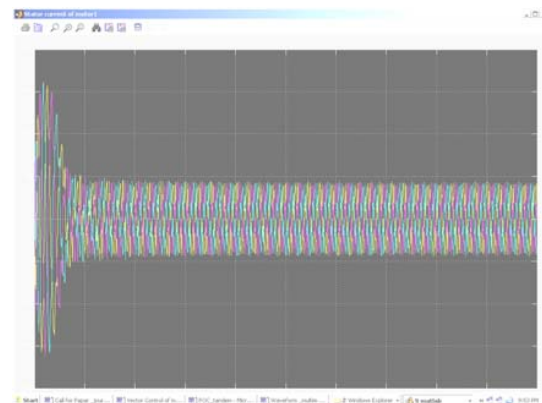

Fig. 5 (a) Waveform of Stator current of Motor 1

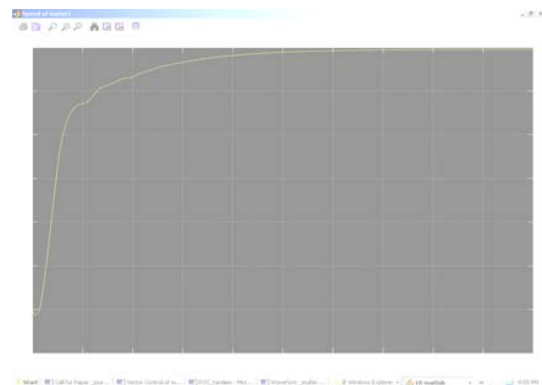

Fig. 5 (b) Waveform of speed of Motor 1

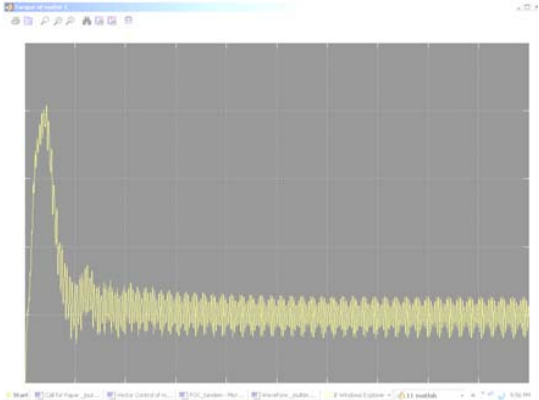

Fig. 5 (c) Waveform of torque of motor 1

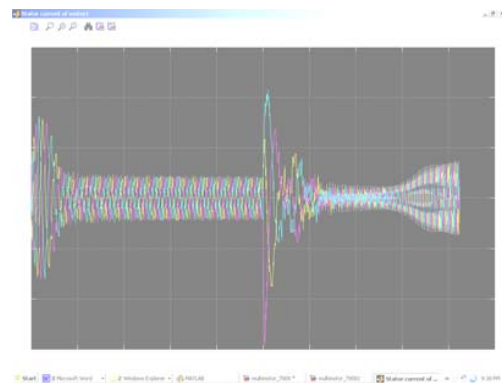

Fig. 7 (a) Waveform for Stator current of motor 1 for change in ref speed

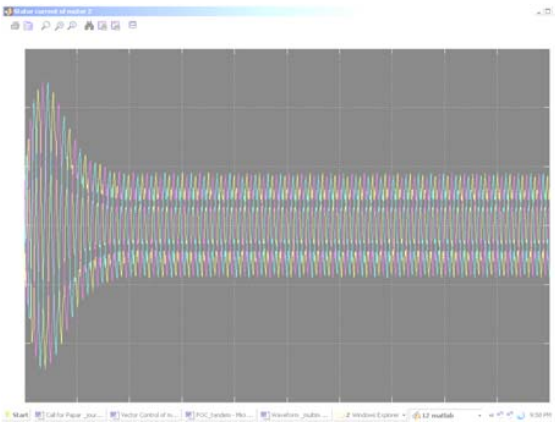

Fig. 6 (a) Waveform of Stator current of motor 2

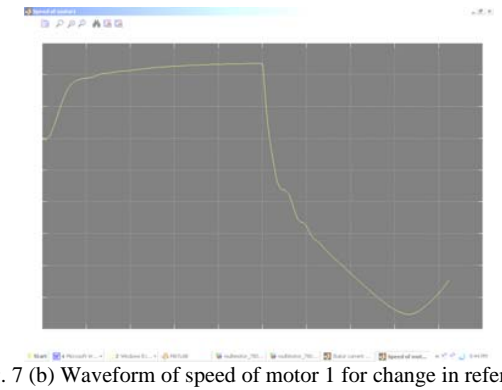

Fig. 7 (b) Waveform of speed of motor 1 for change in reference speed

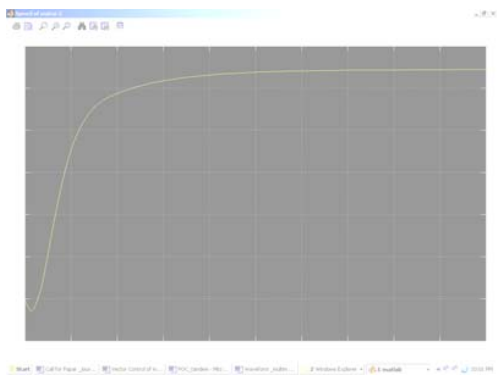

Fig. 6 (b) Waveform of Speed of motor 2

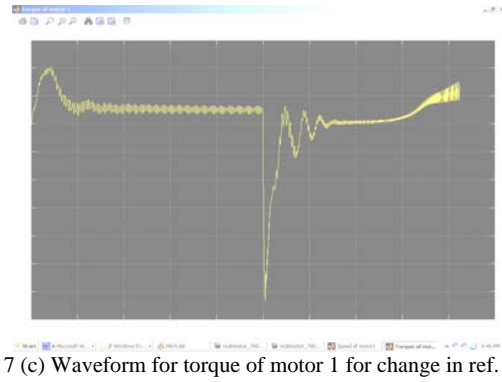

Fig. 7 (c) Waveform for torque of motor 1 for change in ref. speed

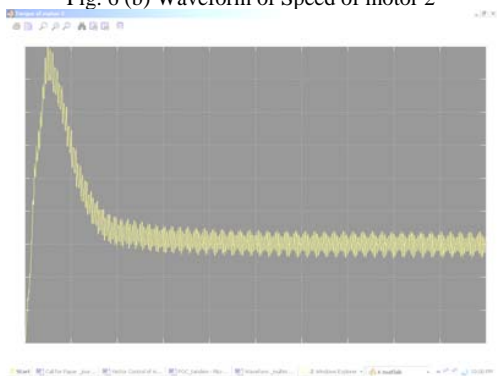

Fig. 6 (c) Waveform of torque of motor 2

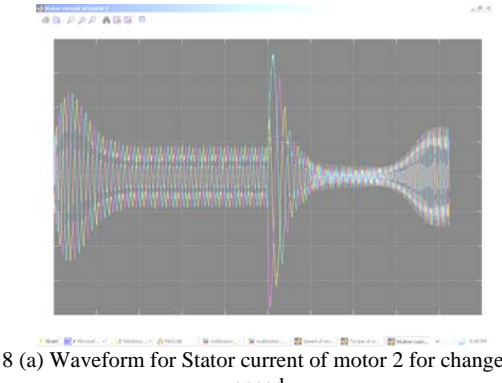

Fig. 8 (a) Waveform for Stator current of motor 2 for change in ref speed

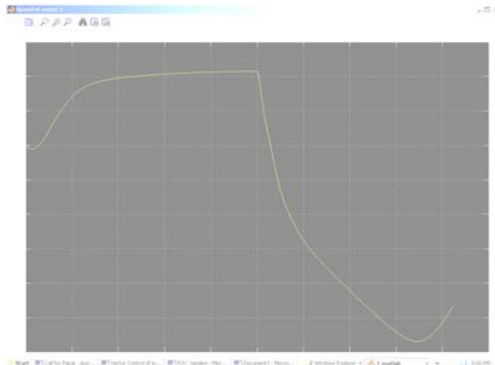

Fig. 8 (b) Waveform of speed of motor 2 for change in reference speed

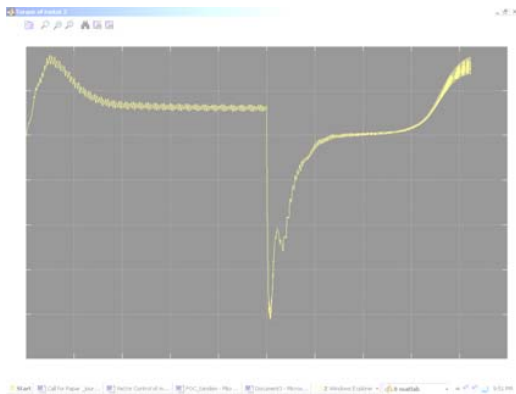

Fig. 8 (c) Waveform for torque of motor 2 for change in ref. speed

#### IV. ADVANTAGES OF PROPOSED SCHEME

Because the CSI supplies the major portion of the stator current, a PWM process is not necessary for control of the whole energy consumed by the motor. As a result, in comparison with an equivalent traditional VSI, the tandem inverter offers a considerable, over 60%, reduction of switching losses. Other advantages include fast reaction to the current control commands, reduced vulnerability to short circuits, reversible power flow thanks to the CSI being supplied from adhoc thyristor rectifier, and a certain degree of redundancy: if one of the constituent converters fails, the other can still keep the drive operational, albeit with reduced quantity or quality of power fed to the motor.

#### V. CONCLUSION

Three phase sinusoidal voltage is converted to dc voltage with the help of universal diode bridge rectifier. Rectified voltage is fed to Voltage source inverter & Current source inverter. Inverter pulses are regulated through Bang- Bang current controller. Two three phase Induction motors are modeled in a synchronously rotating reference frame. Stator currents, Speed & Torque of the induction motor 1 are seen in Fig. 5 (a, b, c). Stator currents, Speed & Torque of the induction motor 2 are seen in Fig. 6 (a, b, c). Speed controller used is PI controller. Flux is calculated in flux calculator &

there from theta is calculated. A Bang-Bang current controller is used. Stator current, Speed & Torque characteristics of motor 1 for change in reference speed can be seen in Fig. 7 (a, b, c). Stator current, Speed & Torque characteristics of motor 2 for change in reference speed can be seen in Fig. 8 (a, b, c).

#### VI. COMPUTER SIMULATION

Computer simulations using Matlab/Simulink have been performed for assessment of operating features of the proposed scheme. The simulation involved a start-up of an unloaded, 5.5-kW, 380-V, 50-Hz motor and 4.5 Kw, 380-V, 50 Hz motor, followed by a step torque command at the rated-torque level and reversal of the drive with the same rated torque. All pertinent mathematical models have been developed individually, using Simulink's S-function blocks for the power electronic converters and the motor (the "Power System" block set could be used as well).

#### REFERENCES

- [1] Maria Imecs, Andrzej M. Trzynadlowski, Fellow, IEEE, Ioan I. Ince, and Csaba Szabo "Vector control schemes for Tandem converter fed induction motor drives" IEEE transactions on power electronics, vol. 20, no. 2, march 2005.
- [2] Bimal Bose, "Modern Power Electronics and AC Drives", Prentice Hall
- [3] R. H. Nelson and P. C. Krause, "Induction machine analysis for arbitrary displacement between multiple windings," IEEE Transactions on Power Apparatus and Systems, vol. 93, pp. 841-848, May 1974.
- [4] T. A. Lipo, "Flux sensing and control of static ac drives by use of fluxcoils," IEEE Transactions on Magnetics, vol. MAG-13, Sept 1997.
- [5] O. Ojo and I. E. Davidson, "PWM-VSI inverter-assisted stand-alone dual stator winding induction generator," IEEE Transactions on Industry Applications, vol. 36, pp. 1604-1611, Nov 2000.



**A. R. Chudasama** was born on May 9, 1956. He received the M.E degree in Electrical Power Engineering from M. S. University, Baroda, India in 1986. He received the Doctoral degree from M. S. University, Baroda, India in 2003. Currently he is working with Faculty of Technology & Engineering, M. S. University as Professor in Electrical Engineering Department. He published & presented more than 35 research papers in various leading journals, seminars and national & international conferences.



International levels.

**Archana Nanoty** was born on 25<sup>th</sup> February 1973. She received the M.E. degree in Electrical Power System from Amravati University (Maharashtra) India in 2007. She is doing her PhD in the area of Drives and control under the guidance of Dr. A.R.Chudasama. Currently she is working as Asst. Prof. in Parul Institute of Engg Technology, Baroda. She is in the field of teaching since 1999. She has presented more than 15 papers at National and