

# Utilization of Kitchen Waste inside Green House Chamber: A Community Level Biogas Programme

Ravi P. Agrahari

**Abstract**—The present study was undertaken with the objective of evaluating kitchen waste as an alternative organic material for biogas production in community level biogas plant. The field study was carried out for one month (January 19, 2012– February 17, 2012) at Centre for Energy Studies, IIT Delhi, New Delhi, India.

This study involves the uses of greenhouse canopy to increase the temperature for the production of biogas in winter period. In continuation, a semi-continuous study was conducted for one month with the retention time of 30 days under batch system. The gas generated from the biogas plant was utilized for cooking (burner) and lighting (lamp) purposes. Gas productions in the winter season registered lower than other months. It can be concluded that the solar greenhouse assisted biogas plant can be efficiently adopted in colder region or in winter season because temperature plays a major role in biogas production.

**Keywords**—Biogas, Green house chamber, organic material, solar intensity.

## I. INTRODUCTION

INDIA is a rural nation where more than eighty percent (80%) peoples are living in rural areas. So the growth of India mostly depends on development of rural villagers, but unfortunately due to various reasons most of villages do not have developed infrastructure to fulfil basic need of easy and cheap source of energy for their own livelihood. So, alternative is non-conventional energy sources. Among various non-conventional energy options biogas is most convenient and cheap technology.

Biogas is a clean unpolluted and cheap source of energy in rural areas. The bio-gas produced from food waste, decomposable organic material and kitchen waste through anaerobic decomposition. Also, the waste materials can be disposed off efficiently without any odour or flies and the digested slurry from the bio-gas unit can be used as organic manure in the garden. It consists of 45-60% methane which is inflammable. To provide fuel for cooking purposes and organic manure to rural household through family type Bio Gas Plants. To mitigate drudgery of rural women, reduce pressure on forests and accentuate social benefits. Bio gas production is mainly by the methanogenesis bacteria. The biogas process consists of three stages; hydrolysis, acidification and methane formation. In the first stage of enzymatic hydrolysis, the extracellular enzymes of microbes, such as cellulase, protease, amylase and lipase externally enzymolize organic material.

Bacteria decompose the complex carbohydrates, lipids and proteins in cellulosic biomass into more simple compounds. During the second stage, acid-producing bacteria convert the simplified compounds into acetic acid, hydrogen, and carbon dioxide. In the process of acidification, the facultatively anaerobic bacteria utilise oxygen and carbon, thereby creating the necessary anaerobic conditions necessary for methanogenesis. In the final stage, the obligatory anaerobes that are involved in methane formation decompose compounds with a low molecular weight, to form methane and CO<sub>2</sub>.

Biogas generation consumes about one-fourth of the dung, but the available heat of the gas is about 20% more than that obtained by burning the entire amount of dung directly. This is mainly due to the high efficiency (60%) of utilization compared to the poor efficiency (11%) of burning dung cakes directly. Several thousand biogas plants have been constructed in developing countries. In India alone, there are an estimated over 250 million cattle and if one third of the dung produced annually from these is available for production of biogas, more than 12 million biogas plants can be installed. It is considered a kind of efficient and renewable energy after cleaning sulphur through physical, chemical and biological methods such as absorption and bioreactor [1], which can be used to cook, heat, light and generate power and can thus reduce the dependency on fossil fuels and curtail green house gas (GHG) emissions. The slurry and residues from the biogas process can be used as an organic fertilizer to replace the use of chemical fertilizer on the farm [2]-[5]. Anaerobic digestion process produce a higher biogas yield when run on a mixture of animal manure and vegetable/crop waste rather than animal manure alone, and biogas production is considered the most suitable bioenergy technology in China [6].

Biogas can be produced from nearly all kind of biological feedstock, like primary agricultural sectors and various organic waste etc. The largest resource is represented by animal manure and slurries from cattle and pig production units as well as from poultry, fish etc. In India million tones of animal manure are produced every year. When untreated or poorly managed, animal manure becomes a major source of air and water pollution. Nutrient leaching, mainly nitrogen and phosphorus, ammonia evaporation and pathogen contamination are some of the major threats. The animal production sector is responsible for 18% of the overall green house gas emissions, measured in CO<sub>2</sub>. Furthermore, 65% of anthropogenic nitrous oxide and 64% of anthropogenic ammonia emission originates from the world wide animal production sector [7]. If handled properly, manure can be valuable resource for renewable energy production and a

Ravi P. Agrahari is with the Centre for Energy Studies, IIT Delhi, New Delhi, India-110016 (Phone: +91 99 11 809 808, e-mail: ravipagahari2010@yahoo.com, ravipagahari\_iitd24@yahoo.com).

source of nutrients for agriculture. There is a positive relationship between N surplus and GHG emission. Each kg of N surplus corresponds with a GHG emission of approximately 30-70 kg CO<sub>2</sub> – equivalents [8]. Due to the lower temperature, biogas production decreases drastically and may stop. Thus, for enhancing biogas production, a higher digester temperature than ambient temperature is required [9].

The green house concept should be integrated for larger capacity biogas plant. The rate of biogas production and the period to achieve the optimum temperature are function of the temperature of the slurry [10], [11]. In general, there is no rule of thumb, but for optimum process stability, the temperature should be carefully regulated within a narrow range of the operating temperature. As a safety measure, it is a common practice either to bury the digesters in the ground on account of the advantageous insulating properties of the soil or to use of solar energy (greenhouse effect) reduces the period to achieve the optimum temperature for biogas production. Solar greenhouse assisted biogas plant in hilly region and have come to conclusion that biogas- green house hybrid system may be successful in hilly regions where average temperature remains below 37°C throughout the year [12]. The fabrication of biogas plant is tried with different materials based on which the cost of installation is highly dependent. Here we used aluminium made biogas plant in biogas production. In this work we have tried to use green house canopy during winter to increase the temperature for biogas production and compare with outside green house chamber under ambient temperature.

## II. EXPERIMENTAL SETUP AND INSTRUMENTATION

An aluminium made biogas chamber of 30kg slurry capacity has been used in outside and inside green house chamber. The diameter and height of all digester are same, have been taken as 0.34m and 0.38m respectively. Similarly the same diameter, depth and weight of both the dome have been taken as 0.30m, 0.35m and 0.18kg, respectively (Fig. 1). Calibrated thermocouples have been used to measure slurry temperature inside the aluminium made biogas plant by using digital temperature indicator of resolution 0.1°C. This field study has been done at roof of block-5, Centre for Energy Studies, IIT Delhi, New Delhi, in the open and green house chamber during winter season (January 19, 2012– February 17, 2012).

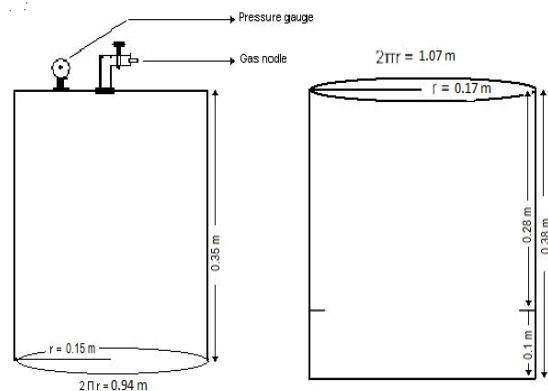

(a)



(b)

Fig. 1 (a) Cross sectional view of dome and digester (b) Photograph of aluminium made biogas plant



(a)



(b)



(c)

Fig. 2 (a) Digester (inside view) (b) Digester inside green house chamber (c) Whole setup of green house integrated biogas chamber

### III. METHODOLOGY AND EXPERIMENTAL OBSERVATIONS

This observation has been taken every day, where we used two different nature of atmosphere, one is the ambient (outside green house and another is inside the green house chamber. These all research has been done in winter season where the ambient temperatures are very less which are not enough for the biogas production which we maintain through green house chamber. In this 30kg total digester capacity we have used 6kg kitchen waste, 18lt. water and 6lt. inoculums. Here inoculum is the anaerobically digested slurry. It contains anaerobic bacteria which are responsible for biogas production. The ratio of kitchen waste and water was 1:3 in this experiment. Its pH value was 7.3 at the time of feeding.

Various parameters like slurry temperature, solar intensity, ambient temperature and average humidity are measured on daily basis. These observations have been taken hourly basis

in the presence of solar radiation. Nine readings have been taken every day from 9:00 am to 5:00 pm until the biogas production inside the biogas chamber stop. In this manner we have also observed the relation of solar intensity with ambient temperature and slurry temperature to find the different result and observation in both outside and inside green house canopy, which shown in Figs. 3-5. We used thermocouple for the measurement of slurry temperature inside the digester during this experiment every day. Gas productions have been recorded on daily basis by the observation of upliftment height of dome. This upliftment height is multiplied by  $2\pi$  and measured the volume of biogas production every day. This biogas sample has been taken out by the help of toddler bags, which is safe to carry biogas without any leakage and entry of atmospheric air, which has been tested through gas chromatography.

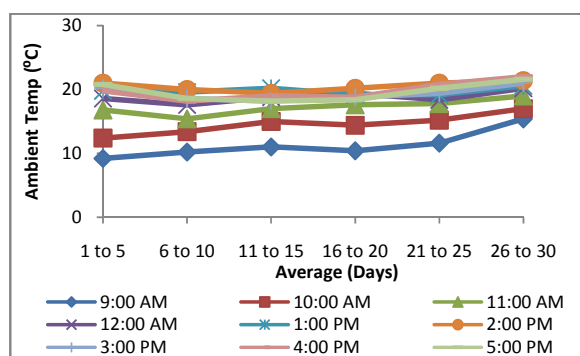

(a) Outside green house chamber

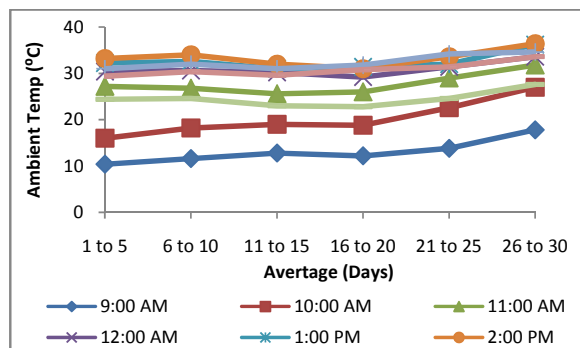

(b) Inside green house chamber

Fig. 3 Ambient temperature vs. average (days) in (a) outside and (b) inside green house chamber

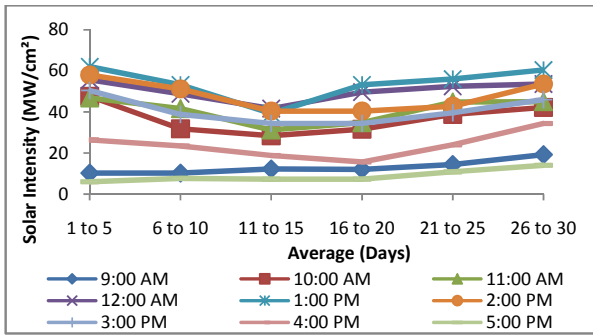

(a) Outside green house chamber

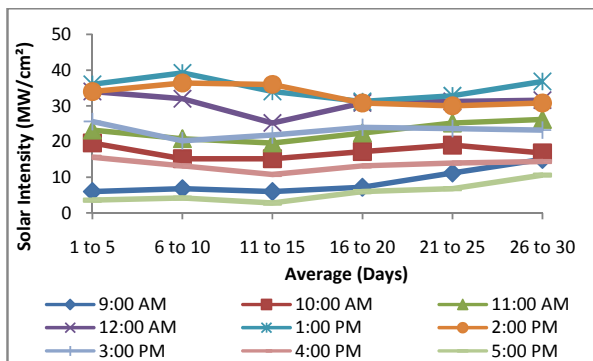

(b) Inside green house chamber

Fig. 4 Solar intensity vs. average (days) in (a) outside and (b) inside green house chamber

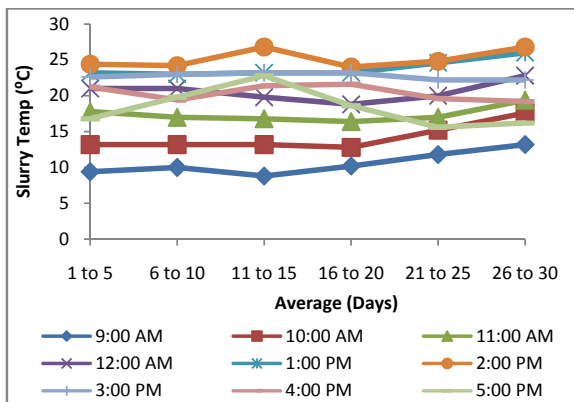

(a) Outside green house chamber

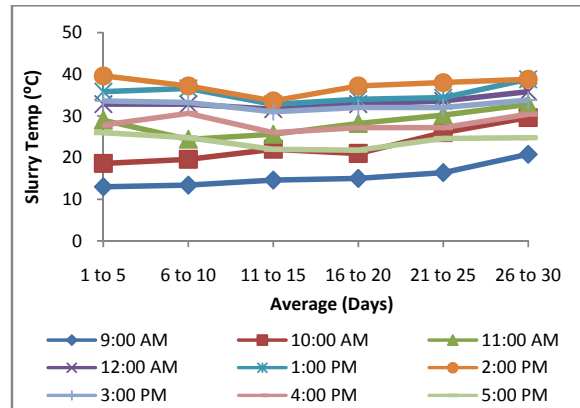

(b) Inside green house chamber

Fig. 5 Slurry temperature vs. average (Days) in (a) outside and (b) inside green house chamber

#### IV. RESULT AND DISCUSSION

In this observation, all the research analysis has been done under batch system. In the batch system, the slurry has been added once to the digester for whole duration of the process. In these studies, it has been observed that the production of biogas is dependent upon the temperature and the solar intensity of the atmosphere.

*A. Outside Green House Chamber:* In ambient atmosphere the rate of biogas production and methane fraction was less due to low atmospheric temperature. In first fifteen days the rate of biogas production and methane fraction increase and then it decrease continuously. Total volume of biogas production during this period was 0.1483 m<sup>3</sup>.

*B. Inside Green House Chamber:* Under green house canopy the rate of biogas production and methane fraction is more due to increase of temperature in comparison to ambient temperature. Total volume of biogas production 0.195 m<sup>3</sup> and here we got the methane fraction up to 52% where as in ambient atmosphere biogas plant maximum methane fraction was 40%. Slurry temperature was always more than ambient temperature during the whole experimentation period. These all parameters are shown in Fig. 6.

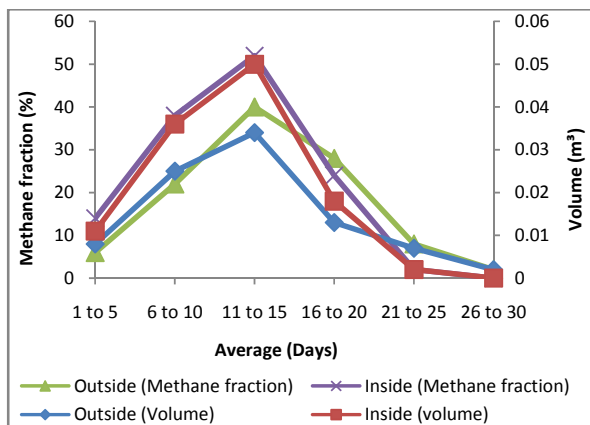

Fig. 6 Methane fraction and volume of biogas production vs. average (Days) in outside and inside green house chamber

#### V. CONCLUSIONS AND RECOMMENDATIONS

In all these measurement where we compare the kitchen waste for biogas production in both outside and inside green house chamber during winter. Here we got a best result inside the green house chamber. During winter period green house canopy will be the good option to increase the surrounding temperature of biogas plant. Aluminium is also better alternative on the basis of biogas production and also safe for the environment because it can easily disintegrate by microorganism but plastic create a lot of environmental problem due to its non biodegradable nature. Here we coat with black paint to increase its longevity and it also increased the absorption rate of sunlight on its surface. It has high heat absorbing capacity comparative to plastic made biogas plant, so it maintains sufficient temperature inside the digester which increases the rate of production of biogas. It is a prototype work where we used 30 kg capacity of digester. If we develop a 1000 kg capacity biogas plant on the roof and covered with green house canopy during winter, will be the good alternative to induce the surrounding temperature of biogas plant. 1000 kg capacity biogas plant is enough to provide fuel for a nuclear family of 4 to 6 member for cooking of food. In this way kitchen waste is a best alternative in community level biogas programme like apartments, hostel, hotel etc. and save LPG.

#### REFERENCES

- [1] Lastella, G., Testa, C., Cornacchia, G., Notornicola, M., Voltasio, F., Sharma, V.K., 2002. Anaerobic digestion of semi-solid organic waste: biogas production and its purification. *Energy Conversion and Management* 43 (1), 63-75.
- [2] Hu, G.Q., 2008. Status, problems and recommendation of biogas development in rural China. *Agricultural Engineering Technology (New Energy Industry)* 5, 15-18 (in Chinese).
- [3] Zhou, C.X., Lin, R.R., 2004. To develop rural biogas and build ecological healthy homeland. *Ecology and Environment* 13 (3), 459-460.
- [4] Liu, Y., Kuang, Y.Q., Huang, N.S., Wu, Z.F., Xu, L.Z., 2008. Popularizing household scale biogas digesters for rural sustainable energy development and green house gas mitigation. *Renewable Energy* 33 (9), 2027-2035.
- [5] Chen, R.J., 1997. Livestock-biogas-fruit systems in South China. *Ecological Engineering* 8, 19-29.

- [6] Wu, C.Z., Yin, X.L., Yuan, Z.Q., Zhnag, X.S., 2009. The development of bioenergy technology in China. *Energy* 35 (11), 4445-4450.
- [7] Steinfeld, H., Gerber, P., Wasenaar, T., Castel, V., Rosales, M., de Haan C., 2006. Livestock's long shadow. Environmental issues and options. Food and Agriculture Organisation (FAO) of United Nations.
- [8] Oenema, O., Diti, Oudendag, Gerard, Velthof, 2006. Nutrient losses from manure management. In: Proceedings at RAMIRAN Conference, Aarhus, Denmark, 2006.
- [9] Lau A.K., Staley L.M., 1987. A design procedure for an air-type solar heating system for green houses. *Energy in Agriculture*. 6(2): 95-119.
- [10] Tiwari G.N., Sharma S.B. and Gupta S.P., 1988. Transient performance of a horizontal floating gas holder type biogas plant. *Energy Conservation and Management*. 28(3): 235-239.
- [11] Tiwari G.N., Chandra A., 1986. Solar assisted biogas system: a new approach. *Energy Conversion and Management*. 26(2): 147-150.
- [12] Kumar K. Vinoth, Bai R. Kasturi, 2008. Solar greenhouse assisted biogas plant in hilly region – A field study. *Solar Energy*. 82: 911-917.

**Ravi P. Agrahari** MSc., is research scholar in Centre for Energy Studies, IIT Delhi, New Delhi, India. Mr. Agrahari was born on December 2, 1981 at Gorakhpur UP in India. Mr. Agrahari completed his masters in botany in 2002 from the Deen Dayal Upadhyay Gorakhpur University, Gorakhpur, UP, India. Then he cleared CSIR-JRF exam in June 2008 and joined as a Research Scholar with Prof. G. N. Tiwari and Prof. M. S. Sodha, Centre for Energy Studies, IIT Delhi, Hauz khas, New Delhi, India. Mr. Agrahari also works as an independent consultant in Bag Energy Research Society, Varanasi, UP, India in the fields of environment, renewable and sustainable energy. His fields of interests include environment and development, socio economic impact assessment, sustainable energy and biogas issues.