

Using Fuzzy Controller in Induction Motor Speed Control with Constant Flux

Hassan Baghgar Bostan Abad, Ali Yazdian Varjani, Taheri Asghar

Abstract—Variable speed drives are growing and varying. Drives expand depend on progress in different part of science like power system, microelectronic, control methods, and so on. Artificial intelligent contains hard computation and soft computation. Artificial intelligent has found high application in most nonlinear systems same as motors drive. Because it has intelligence like human but there are no sentiment against human like anger and.... Artificial intelligent is used for various points like approximation, control, and monitoring. Because artificial intelligent techniques can use as controller for any system without requirement to system mathematical model, it has been used in electrical drive control. With this manner, efficiency and reliability of drives increase and volume, weight and cost of them decrease.

Keywords—Artificial intelligent, electrical motor, intelligent drive and control,

I. INTRODUCTION

BECAUSE induction motors require low maintenance and are robust [8], have many applications in industry [9]. Along with industry progress, it indicates requirement to progress drive with high performance [8]. DC motors are control abler than AC motors but they require much cost. In addition, in equal power, DC motors have higher volume and weight. Main variations in semiconductors, converters topology, analyze technique and simulation of electrical machines drive and newer control technique have had role in this progress [1].

Usually classical control is used in motors drive [8,10,11]. Design and implementation of Conventional controls have difficulties that nameable:

- a) It is basis on mathematical accurate model of system that usual it is not known [12,13].
- b) Drives are nonlinear systems and Classical control performance with this system decrease [9,13].
- c) Variation of machine parameters (especially in vector control [12]) by load disturbance [9], motor saturation [9,13] or thermal variations [13] do not cause expectation performance [9,13].
- d) Classical linear control shows high performance only for one unique act point [13].
- e) With choose improperly coefficient, classical control cannot receive acceptable result and suitable choose for constant coefficient in especial application condition with set point varying, necessarily is not optimum [14].

□

Hassan Baghgar Bostan Abad is with Mianeh Islamic Azad University (e-mail: baghgar@yahoo.com)

Ali Yazdian Varjani is with Tarbiat Modares University

Taheri Asghar is with Maleke Ashtar Technical University

Artificial intelligent techniques have extensive application in sciences [19]. Artificial intelligent embedding human intelligence into a machine so that it can think like a human being [19]. Because artificial intelligent technique can be used as every system controller without requiring to system mathematical model, application of artificial intelligent technique are increasing in electrical drives [1,19]. Advanced control based on artificial intelligent technique is called intelligent control [12,19] that is known with "automatic control", "adaptive control" or "self organizing control" [12]. In addition, simplicity in implementation, noise influence cancellation elimination, system disturbance elimination and parameter variation decreasing are intelligent control enabling [13].

Application of artificial intelligent techniques in electrical drives is increasing [7,12,1,20,21]. Intelligent controls act better than conventional adaptive controls [13,19].

II. INTELLIGENT DRIVES

Motor drives contain three main parts: motor, controller and power electronic unit. If with a manner, intelligence factor is summed to one of this sections, that drive is called intelligent drive.

A. Smart power switch

Smart power switch are devices that are produced with add pieces without require to main variation in previous design. They contain over voltage, current limiter, dV/dt or dI/dt , protection sensors [22,23,24]. These switches are used for switches protection against over voltage or current and maybe wrong resultant improperly circuit connection.

Also maybe division of circuit is designed and produced along with switch. Therefore, can increase reliability and application range of switch, circuit complexity and drive control system decreases so it causes simplistic design.

B. Intelligent control

Controller in a driver is brain and decision center that contains two part, hardware and software. Hardware of controller unit has progressed in recent two decades. Software of control unit contains various control techniques that they are programmed into hardware.

Usually classical control is used in electrical motor drives. Conventional control is basis on know model of controlled system [25]. When there are system parameters variation [25] or environmental disturbance [26], behavior of system is not satisfactory [25,26]. In addition, usual computation of system mathematical model is difficult or impossible [26]. For design and tuning of conventional controller, there are many techniques like Broida [10,27]

and Nyquist or Bode diagram [12]. Using of classical controller in electrical motor drive with high performance is complexity and difficult [14,15].

Advanced control based on artificial intelligence techniques is called intelligent control [19]. Every system with artificial intelligent is called self-organizing or autonomous system [2,5]. On 80 decade with fast growing in design and production of electronic circuits, microprocessors also were being high computation ability and speed. Availability [12,19] and powerful ability and industrial modern processors [8], DSP¹, FPGA² and ASIC³ ICs with high power and speed and low cost [13] along with power electronic switches (like IGBT and IGCT [1]) cause that Intelligent control has been used widely in electrical drives [12].

Artificial intelligent techniques divide two groups: hard computation and soft computation [2,4,5,8]. Expert system is belong hard computational that has been first artificial intelligent techniques [2,5]. Recently expert system has found wild application but has not had more application in electrical drives [2,8]. In recent two decades, soft computation has used more in electrical drives as microprocessor architecture improvement. Mains of them are:

- Artificial neural network (ANN)
- Fuzzy logic set (FLS)
- Fuzzy-neural network (FNN)
- Genetic algorithm based system (GAB)
- Genetic algorithm assisted system (GAA)

C. Smart motors

When monitoring and condition diagnosis are used with artificial intelligent during system Operation, permit machine that it shown intelligence [8]. In smart motors with sensors that are used in design and production, motor can test itself every time until is created a wrong like voltage or current increasing or temperature arising. Then it out puts itself from circuit automatically.

III. LABORATORY PROTOTYPE IMPLEMENTATION

This paper is intentioned three phases induction motor drive based fuzzy logic controller (FLC). Constant flux technique (V/F) [10,29,31] is used for induction motor speed control. For test of proposed fuzzy logic controller performance, driver is implemented.

A. Block diagram of implemented circuit

Block diagram of implemented drive has shown in figure (1).

Using fuzzy logic principles in induction motor speed control has described in [6]. Figure (2) shows block diagram of PI fuzzy logic controller [30,3]. Speed error ($\Delta\omega_1 = \omega_i - \omega_{f1}$) is calculated with comparison between reference speed command and speed signal feedback. Speed error and speed error changing are fuzzy controller inputs,

speed error changing ($\Delta(\Delta\omega) = \Delta\omega_2 - \Delta\omega_1$) is be calculated.

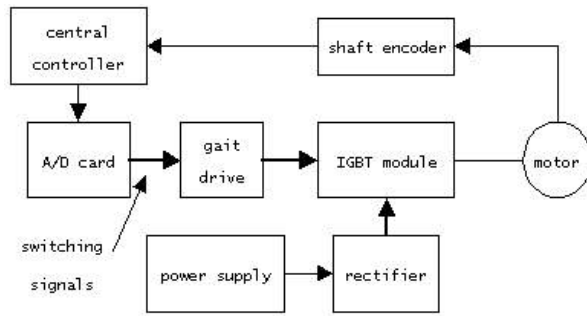

Fig. 1 Block diagram of implemented drive

Input variables require be normalized which range of membership functions specify them, in figure (2) normalization factors have shown with K1 and K2. Suitable normalization has direct influence in algorithm optimality and faster response [30,6].

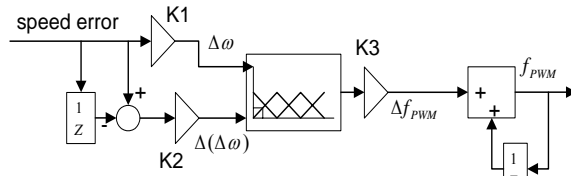

Fig. 2 Block diagram of PI fuzzy logic controller

Figure (3) shows normalized membership functions for input and output variables. Fuzzy logic controller operation is basis on control expression of table I.

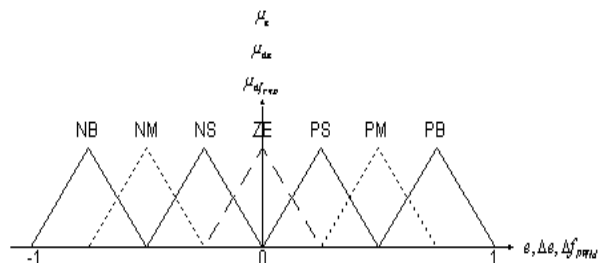

Fig. 3 Input and output Membership functions

TABLE I
FUZZY CONTROLLER OPERATION

	Δe	NS	NM	NS	ZE	PS	PM	PB
e	Output	NS	NM	NS	ZE	PS	PM	PB
NB	NB	NB	NM	NM	NS	NS	NS	ZE
NM	NB	NM	NM	NS	NS	ZE	PS	PS
NS	NM	NM	NS	NS	ZE	PS	PS	PM
ZE	NM	NS	NS	ZE	PS	PS	PM	PM
PS	NS	NS	ZE	PS	PS	PM	PM	PB
PM	NS	ZE	PS	PS	PM	PM	PB	PB
PB	ZE	PS	PS	PM	PM	PB	PB	PB

B. Laboratory results

For evaluation of implemented drive, different responses of drive are presented. Sampling time and interrupt time are 2ms and 20us respectively.

¹ - Digital Signal Processor
² - Field Programmable Gate Array
³ - Application Specific Integrated Circuit

Step response of for 600 rpm reference speed with no load, No load reference speed respectively. In these tests, also, load and full load condition has represented respectively in figure (4-a) and (4-b). Responses have drawn for 2 sec that motor speed is according to RPM. These responses is compared a driver responses with classical controller. In figures, driver responses with fuzzy controller are specified "FUZZY" and classical controller is represented "PI". In full load, driver response has almost similar trajectory with classical and fuzzy controller. Rise time nearly is 0.1 sec also in responses has be seen no overshoot. In no load, driver with fuzzy controller has response faster than classical controller response. Driver with fuzzy controller has almost received to reference speed at 0.1 sec, as this time in classical controller s nearly 0.15 sec. driver responses have not any overshoot.

Steady state error is %5 for each response. Few speed subsidence in steady state shows that motor flux has been fixed, comparison with no load condition. Because with load changing motor speed has not changed much and speed regulation is nearly suitable.

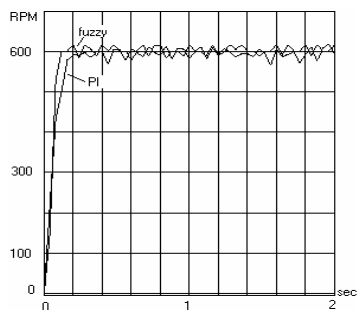

(a): no load

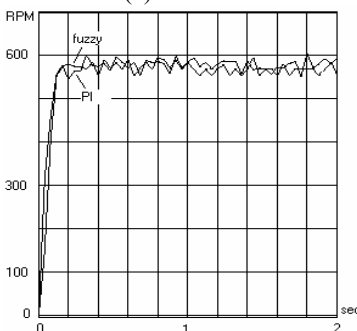

(b): full load

Fig. 4 Step response

In another test, sudden changing has exerted in motor command speed. Speed command changing has been in tow cases: no load and full load with increasing and decreasing speed command.

Driver responses are depicted in figure (5) for no load case. Figures (5-a) and (5-b) show driver responses. In sudden increasing speed, first motor command speed is 400 rpm. Reference speed is changed to 700 rpm at t=1 sec but in decreasing speed, primary motor speed is 700 rpm which is decreased to 400 rpm at t=1 sec. rise time in each case is nearly 0.1 sec. also there are no overshoot in responses and steady state error is dispensable. In these tests, speed regulation is almost suitable.

In figure (6) has depicted driver response to sudden speed changing in full load case. Driver responses have shown in figures (6-a) and (6-b) for increasing and

decreasing reference speed respectively. In these tests, also, reference speed changing is exerted at t=1 sec. steady state error is almost %5. In each condition, driver rise time is less than 0.1 sec. driver response has not any overshoot.

Figure (7) shows driver response with changing in load. In steady state, motor speed is 700 rpm. At t=1 sec motor load is changed amount %10 of nominal load. In this condition motor speed decrease, approximately 40 rpm during 0.4 sec. as can see in figure after this time, motor speed returns to primary speed again.

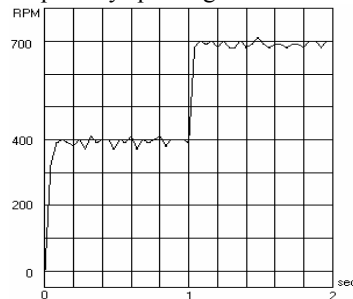

(a): increasing

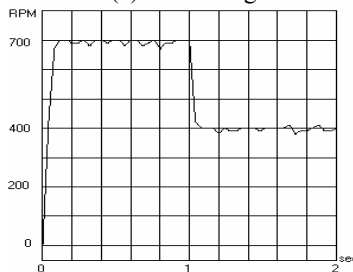

(b): decreasing

Fig. 5 Sudden speed command changing-no load

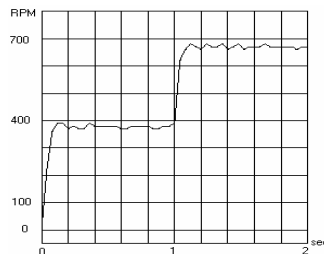

(a): increasing

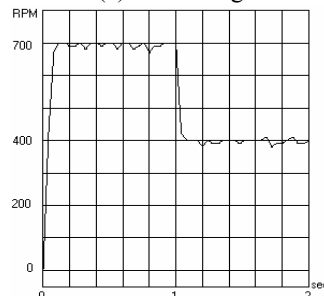

(b): decreasing

Fig. 6 Sudden speed command Changing-full load

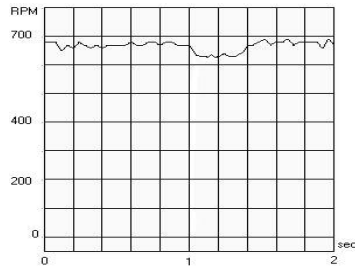

Fig. 7 Load-changing response

IV. CONCLUSION

Artificial intelligent technique can be used as electrical motor controller without requiring a system mathematical model. By this way, efficiency, performance and reliability of drives increase and volume, weight and cost of them decrease. For test of performance of an electrical motor drive, with fuzzy logic controller was implemented. It does not require an accurate motor and drive model. Induction motor drive was implemented with suitable speed regulation. Steady state error in speed control is acceptable and there is not any overshoot. Laboratory tests of speed driver show that design and implementation are suitable.

REFERENCES

- [1] B.K.Bose, " Power Electronics and Motor Drives-Recent Technology Advances ", Proceedings of the 2002 IEEE International Symposium on Industrial Electronics, Vol.1, pp.22-25, 2002.
- [2] B.K.Bose, " Expert System, fuzzy Logic, and Neural Network Applications in Power Electronics and Motion Control " Proceedings of the IEEE, Vol.82, pp.1303-1323, Aug 1994.
- [3] K.Rattan, T.Brehm and Gurpreet Sandhu, " Analysis and Design of Proportional Fuzzy Logic Controller ", 6th IFCICC, April 96.
- [4] S.L.Jung, M.Y.Chang, J.Y.Jyang, L.C.Yeh, and Y.Y.Tzon, " Design and Implementation of An FPGA-Based Control IC for AC-Voltage Regulation ", IEEE
- [5] Bimal K.Bose, Power Electronics And Variable Frequency Drives, New York, IEEE Press, 1997.
- [6] C.C.Lee, " Fuzzy logic in Control Systems: Fuzzy Logic Controller I & II ", IEEE Transactions On Systems, Man and Cybernetics, Vol.20, pp.404-418, March- April 1990.
- [7] P.Vas, A.F.Stronach, M.Neuroth, " Application of Conventional and AI-based Techniques in Sensorless High-Performance Torque-Controlled Induction Motor Drives ", IEE Colloquium on Vector Control Revisited, pp.8/1-8/7, 23 Feb 1998.
- [8] F.D.S.Cardoso, J.F.Martins, V.F.Pires, " A Comparative Study of a PI, Neural Network and Fuzzy Genetic Approach Controllers for an AC Drive " 5th International Workshop on Advanced Motion Control, pp.375-380, 29 Jun 1998.
- [9] Ye Zhongming, Wu Bin, " A Review on Induction Motor Online Fault Diagnosis " The Third International Power Electronics and Motion Control Conference Proceedings. PIEMC 2000, Vol.3, pp.1353-1358 vol.3, 2000.
- [10] R.Echavarria, S.Horta, M.Oliver, " A Three Phase Motor Drive Using IGBTs and Constant V/f Speed Control with Slip Regulation ", IV IEEE International Power Electronics Congress, Technical Proceedings, pp.87-91, 1995.
- [11] A.Munoz-Garcia, T.A.Lipo, D.W.Novotny, " A New Induction Motor V/f Control Method Capable of High-Performance Regulation at Low Speeds ", IEEE Transactions On Industry Application, Vol.34, pp.813-821, July-Aug. 1998.
- [12] B.K.Bose, " Intelligent Control and Estimation in Power Electronics and Drives " IEEE International Electric Machines and Drives Conference Record, pp. TA2/2.1-TA2/2.6, May 1997.
- [13] T.G.Habetler, R.G.Harley, " Power Electronic Converter and System Control " Proceedings of the IEEE, Vol.89, and Issue: 6, pp.913-925, Jun 2001.
- [14] M.R.Tamjis, W.P.Hew, M.R.Anas, W.A.Adnan, " Intelligent Electric Drive System " TENCON 2000. Proceedings, Vol.3, pp.334-335, 2000.
- [15] H.Sugimoto and S.Tamai, " Secondary Resistance Identification of an Induction Motor Applied Model Reference Adaptive System and its Characteristics ", IEEE Trans. On Ind.Appl. , Vol.23, no.2, pp.296-303, March/April 1989.
- [16] C.Y.Won and B.K.Bose, " An Induction Motor Servo System with Improved Sliding Mode Control ", IEEE Conf.Rec.of IECON'92, pp.60-66, 1992.
- [17] T.L.Chen and Y.C.Wu, " Design of Integral Variable Structure Controller and Application to Electrohydraulic Velocity Servo System ", IEE Proceedings, vol.138, no.5, pp.439-444, september 1991.
- [18] J.C.Hung, " Partial Industrial Control Technique ", IEEE Copnf.Rec.of IECON'94, pp.7-14, 1994.
- [19] B.K.Bose, " Fuzzy logic and neural networks in power electronics and drives " IEEE Industry Applications Magazine, pp.57-63, Vol.6, May/Jun 2000.
- [20] S.M.Chhaya, B.K.Bose, " Expert System Aided Automated Design, Simulation and Controller Tuning of AC Drive System " Proceedings of the 1995 IEEE IECON 21st International Conference on Industrial Electronics, Control, and Instrumentation, 1995, pp.712-718, Vol.1, 6-10 Nov 1995.
- [21] Y.Dote, R.G.Hoft, " Control and Diagnosis for AC Drives and UPS Systems Using Soft Computing ", Proceedings of the Power Conversion Conference - Nagaoka, Vol.1, pp.519-524, Aug 1997.
- [22] L.Afandilian, V.Mangtani, A.Dubhashi, " Advances in Power Semiconductors and Packaging Lead to a Compact Integrated Power Stage for AC Drives " WESCON/97. Conference Proceedings, pp.334-339, 4-6 Nov 1997.
- [23] Ned mohan, Tore M.Undeland and Wiliam P.Robbins, Power Electronics, New York, John Wiley & Sons, Press, 1998.
- [24] Nihal Kularatna, Power Electronics Design Handbook, Boston, Newnes, 1998.
- [25] G.D'Angelo, M.Lo Presti, G.Rizzotto, " Fuzzy Controller Design to Drive an Induction Motor ", Proceedings of the Third IEEE Conference on Fuzzy Systems, Vol.3, pp.1502-1507, 1994.
- [26] S.Boverie, B.Demaya, A.Titli, " Fuzzy Logic Control Compared with Other Automatic Control Approaches ", Proceedings of the 30th IEEE Conference On Decision and Control, vol.2, pp.1212-1216, 1991.
- [27] A.B.Corrigo, Tuning of industrial Control System, North Carolina: Instrument Society of America, pp.164-200, 1990.
- [28] A.Davies, " The intelligent machine " Manufacturing Engineer, Vol.73 Issue: 4, pp.182-185, Aug 1994.
- [29] A.Gupta, " Simulation of Variable Speed Squirrel Cage Induction Motor Constant Volts/Hertz Operation ", IEEE International on Electric Machines and Drives Conference Record, pp. TB3/8.1 - TB3/8.3, 1997.
- [30] S.A.Mir, D.S.Zinger, M.E.Elbuluk, " Fuzzy Controller for Inverter Fed Induction Machines ", IEEE Transactions on Industry Applications, Vol.30, pp.78-84, Jan.-Feb. 1994.
- [31] B.S.zhang and J.M.Edmunds, " On fuzzy logic controllers ", IEE international Conference on control, pp.961-965, Edinburg, U.K, 1991.