

# Testing the Accuracy of ML-ANN for Harmonic Estimation in Balanced Industrial Distribution Power System

Wael M. El-Mamlouk, Metwally A. El-Sharkawy, and Hossam. E. Mostafa

**Abstract**—In this paper, we analyze and test a scheme for the estimation of electrical fundamental frequency signals from the harmonic load current and voltage signals.

The scheme was based on using two different Multi Layer Artificial Neural Networks (ML-ANN) one for the current and the other for the voltage.

This study also analyzes and tests the effect of choosing the optimum artificial neural networks' sizes which determine the quality and accuracy of the estimation of electrical fundamental frequency signals.

The simulink tool box of the Matlab program for the simulation of the test system and the test of the neural networks has been used.

**Keywords**—Harmonics, Neural Networks, Modeling, Simulation, Active filters, electric Networks.

## I. INTRODUCTION

FOR the last few years, many different topologies have been developed for harmonic currents and voltages extraction from the AC line. The quality, speed and accuracy of these extracted signals are very important in active harmonic filter control. Some topologies for the extraction are based on the classical fast Fourier transform theory, Instantaneous Power Theory (IPT), ADALINE Artificial Neural Network (ANN) and Particle Swarm Optimization (PSO).

The classical fast Fourier transform theory is the most intuitional and basic method that can virtually solve any composition and decomposition problems but it takes a long time to solve the equations, which is not suitable for the online power filtering and instantaneously varied signals.

Others propose [1] to use four ADALINES as an alternative for online extracting of the direct, inverse, and homopolar voltage components from a composite voltage.

The first two ADALINE (the Current ADALINE) extracts the harmonic components of the distorted line current signal

and the second two ADALINE (the Voltage ADALINE) estimates the fundamental component of the line voltage signal.

Reference [3] presents an algorithm for harmonic estimation. It utilizes the particle swarm optimizer with passive congregation (PSOPC) to estimate the phases of the harmonics, alongside a least-square (LS) method that is used to estimate the amplitudes. The estimation accuracy is greatly improved in comparison with that of the conventional discrete Fourier transform.

Some controls of the active filter's current are performed by means of the dead-beat control technique which calculates the phase voltage; so as to make the phase current reaches its reference by the end of the following modulation period. A serious drawback of this control technique is an inherent delay due to the calculation time [4].

The goal of the study is to analyze and test a scheme based on using two different Multi Layer Artificial Neural Network (ML-ANN) with shift method for input samples[5] using a sample by sample investigation of the input signal.

The scheme was based on using two different (ML-ANN), one for the current and the other for the voltage.

These tests are conducted using three different architectures employing ML-ANN to compare the THD of the estimated fundamental signals.

We used the current harmonic modeling contents of an adjustable speed drive (ASD) as an example of a harmonic produced load connected at different locations of the test system consisting of 13 buses Balanced Industrial Distribution System extracted from the whole system presented at [6] and with different loading conditions and at different locations for the harmonic loads.

We test the accuracy of the estimated fundamental frequency components by decomposing the output signal using the classical fast Fourier transform theory for the twelve cases under the test stage of the ANN.

## II. GENERAL DESIGN OF THE ML-ANN

The sizes of networks depend on the number of layers and the number of hidden-units per layer.

By varying the number of hidden layers and the number of simulated neurons within each layer the performance of a ANN can be improved or degraded.

Wael M. El-Mamlouk is Senior Electrical Engineer, Cairo, Egypt (e-mail: wmamamlouk@yahoo.com).

Metwally A. El-Sharkawy is working with Electrical Power and Machines Department, Ain Shams University, Cairo, Egypt (e-mail: masharkawy@yahoo.com).

Hossam.E. Mostafa is working with Electrical Department, Jazan University, Jazan, Kingdom of Saudi Arabia (e-mail: hossam65eg@yahoo.com).

The number of hidden-units is directly related to the capabilities of the network. For the best network performance, an optimal number of hidden-units must be properly determined [7].

III. ARCHITECTURE OF THE PROPOSED ML-ANN

A. Training of ML-ANN

We use 32 input nodes including 16 samples per cycle and 16 samples from the previous cycle. The ANN performs a sample by sample investigation of the input samples, the oldest sample is omitted and all the remaining samples are displaced at once to the neighbor position leaving an empty position to the new sample as shown in Fig. 1. Tansigmoidal function is used in the two hidden layers, while the output layer uses purelin function.

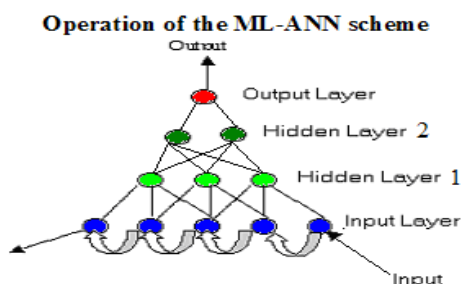

Fig. 1 Operation of the ML-ANN scheme

The ANN parameters in this study were as follows:

Epochs between updating display = 200.

Maximum number of iterations to train = 40000.

Sum-squared error goal will be tested for three different cases = 0.02, 0.01 & 0.005.

The numbers of neurons for the two hidden layers will be tested with three different (ML-ANN) networks as shown in Table I.

TABLE I  
CONFIGURATION OF THE NEURAL NETWORKS USED FOR TEST

	Hidden 1	Hidden 2
Network 1	24	16
Network 2	21	14
Network 3	18	12

The same architecture for two adaptive linear neurons (ML-ANN) is utilized to process the signals obtained from the power-line. The first (ML-ANN) (the Current network) extracts the harmonic components of the distorted line current signal and the second (ML-ANN) (the Voltage network) estimates the fundamental component of the line voltage signal. The outputs of the two (ML-ANN) will be useful for constructing the modulating signals of active harmonic filters.

B. Testing of ML-ANN

When building the training data set, we should hold a selected number of historical observations. These observations

will never be shown to the network during training. They will be used after training is finished to test the network and benchmark its performance. There are several numerical measures that can be used to judge the output of the network. The mean squared error of the network output is the more popular way.

C. Select Alternative Network Architecture and Retraining

Once the network has been trained to its lowest error, alternative network architectures should be tried. There are no guidelines for selecting the optimum architecture for a given set of data. Finding the structure of ANN means number of hidden layer and number of simulated neurons in each hidden layer.

Reference [9] presents harmonic simulation for three test systems as the most common harmonic study scenarios encountered in industry. The purpose was to simulate test system harmonic to demonstrate guidelines for the preparation and analysis of harmonic problems through case studies and simulation examples. The study was useful for the development of new harmonic simulation methods and for the evaluation of existing harmonic analysis software.

IV. TEST SYSTEM

The test system used consists of 13 buses Balanced Industrial Distribution System (BIDS) as shown in Fig. 2 and is representative of a medium-sized industrial plant.

The system is extracted from a common system that is being used in many of the calculations and examples in the IEEE Color Book series [6]. Due to the balanced nature of this example, only positive sequence data is provided, Capacitance of the short overhead line and all cables are neglected.

All lines and cables impedance data for the test system are given in [9]. Also all transformers data, parameters, and power flow for the generation, load, and bus voltage data for the 13 buses (BIDS) are also given in [9]

We choose the point of common coupling (PCC) in this study to be at the secondary side of the transformer connected to bus 29 which will be monitored.

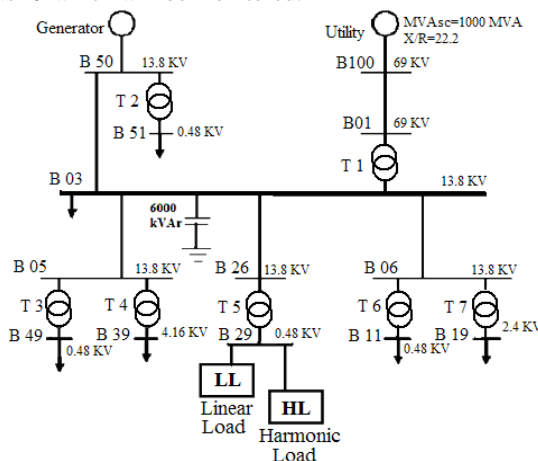

Fig. 2 The modified 13 buses (BIDS) Test system presented at [5]

Also Fig. 2 shows the modified 13 buses Balanced Industrial Distribution Test system with the connection of the linear load at bus 29 (PCC) as it is the medial branch of the system and also the ASD controlling a number of parallel motors in some of study cases.

An adjustable speed drive (30 hp PWM-type ASD) used as a harmonic source serving a number of parallel 20 hp electrical three-phase induction motor has been modeled by harmonic current sources. Each harmonic content is modeled by a current source with frequency multiple integers of the fundamental frequency and magnitude, phase angle related to the fundamental current as shown in the Table II [10].

TABLE II  
CURRENT INJECTION MODEL FOR ASD

n-order	100%		75%		50%	
	Mag.	Angle	Mag.	Angle	Mag.	Angle
1	100.0	0	100.0	0	100.0	0
3	0.35	-159	0.59	-44	0.54	-96
5	60.82	-175	69.75	-174	75.09	-174
7	33.42	-172	47.03	-171	54.61	-171
9	0.50	158	0.32	-96	0.24	-102
11	3.84	166	6.86	17	14.65	16
13	7.74	-177	4.52	-178	1.95	71
15	0.41	135	0.37	-124	0.32	28
17	1.27	32	7.56	9	9.61	10
19	1.54	179	3.81	9	7.66	16
21	0.32	110	0.43	-163	0.43	95
23	1.08	38	2.59	11	0.94	-8
25	0.16	49	3.70	10	3.78	7

V. STUDY OF ML-ANN SCHEME WITH TEST SYSTEM

In this scheme we used two different stages with the 18 cases applied to the test system. At the first stage we will use the current and voltage measurements separately from 6 cases to train the (ML-ANN) to estimate the current and voltage weight matrix which will be used to estimate the fundamental current or voltage.

In the second stage we will apply the estimated the current and voltage weight matrixes to another 12 cases of the test system to ensure the effectiveness and the reliability of the estimated weights and accordingly the proposed scheme based on (ML-ANN). The estimated fundamental frequency component will be tested by calculating the THDi and THDv and comparing them with the IEEE 519-1992 standard [8] for each current and voltage of the 12 cases before applying the (ML-ANN) scheme and after getting the output signals which represent the estimated fundamental frequency component. Also we used the classical fast Fourier transform theory to decomposition of the output signals for each case.

A. Training Stage for the Test System Cases

We connect the harmonic sources to 3 buses from the system. These buses were (B29, B11 & B51) which have the same voltage level 480V 3 phase.

By using different combinations from the harmonic sources distributed on the three Buses (B29, B11 & B51) separately or combined and with different loading conditions 50%, 75% & 100% for the ASD controlling the induction motors to get

the 6 different cases for training.

Fig. 3 shows the training stage, learning rate and the number of Epochs until we reach the SSE goal.

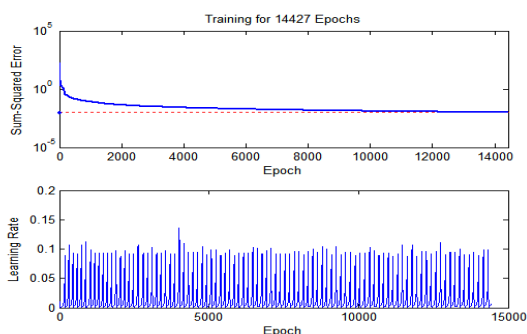

Fig. 3 Training stage for the ML-ANN

We measured the currents and voltages on bus 29 for each case and used them as an input signals to the ML-ANN. These cases are described in Table III.

TABLE III  
INPUT CASES FOR THE ML-ANN TRAINING STAGE

Case	Bus 29		Bus 51		Bus 11		Linear Load Bus 29	
	Motor equivalent hp	ASD load level %	Motor equivalent hp	ASD load level %	Motor equivalent hp	ASD load level %	KW	KVAr
1	800	57	-	-	1200	50	700	200
2	800	75	400	100	800	100	600	400
3	800	50	800	75	800	100	600	600
4	800, 600	50, 100	-	-	-	-	200	200
5	800, 400	75, 50	-	-	-	-	600	200
6	800, 400, 400	50, 100, 75	-	-	-	-	300	0

Table IV shows the calculated total harmonic distortion for the current and voltage input signal used for the training stage of the proposed ML-ANN that all the cases are exceeding the allowable limit by IEEE 519-1992 [8].

TABLE IV  
THDi% AND THDv % FOR INPUT SIGNAL FOR TRAINING STAGE

Training Cases	Input	
	THDi%	THDv%
1	35.890	12.790
2	36.570	14.760
3	28.950	13.330
4	60.530	18.100
5	46.300	15.760
6	66.260	21.120

### B. Testing Stage for the Test System Cases

In this stage we used different combinations other than those used at the training stage of the test system for the harmonic sources distributed on the three Buses (B29, B11 & B51) separately or combined and with different loading conditions 50%, 75% & 100% for the ASD controlling the induction motors to get 12 different cases as described in Table V to test the weights estimated from the scheme at the training stage.

TABLE V  
INPUT CASES FOR THE ML-ANN TESTING STAGE

Case	Bus 29		Bus 51		Bus 11		Linear Load B 29	
	Motor equivalent hp	ASD load level %	Motor equivalent hp	ASD load level %	Motor equivalent hp	ASD load level %	KW	KVAr
7	600	100	600	100	800	100	600	600
8	800, 400	100, 75	-	-	-	-	300	100
9	400, 400, 400	100, 75, 50	-	-	-	-	400	200
10	1200	75	800	50	-	-	400	100
11	400, 800	100, 50	800	50	-	-	500	200
12	1200	50	-	-	800	50	700	300
13	400, 1200	75, 50	-	-	800	50	500	100
14	400	50	800	75	800	50	1200	300
15	-	-	800	75	1200	50	1000	600
16	1200	100	-	-	-	-	200	100
17	400	75	400	75	400	75	800	800
18	800	100	1200	50	1200	50	300	300

Also we did the same testing stage with three different sizes of the neural network as described in section III above.

Table VI shows the calculated total harmonic distortion for the current and voltage input signal used for the testing stage of the proposed ML-ANN.

TABLE VI  
THDi% AND THDv % FOR INPUT SIGNAL FOR TESTING STAGE

Testing Case	Input	
	THDi%	THDv%
7	27.340	13.930
8	55.660	18.390
9	51.450	16.210
10	56.440	18.270
11	46.460	15.320
12	39.290	13.770
13	56.080	19.410
14	11.880	7.972
15	2.486	8.122
16	57.660	19.570
17	16.790	7.684
18	44.290	17.770
Average	38.819	14.702

Fig. 6 shows that all the cases are exceeding the allowable limit by IEEE 519-1992 [8].

#### 1. Testing for Neural Network 1

Neural network 1 is consisting of the following layers:

Input = 32

Hidden 1 = 24

Hidden 2 = 16

This network has been tested with the 12 cases shown in Table V to achieve a min. THDi and THDv and with different Sum squared Error Goal (SSE) as shown in Table VII at each time we calculate the THDi and THDv for the estimated signal.

TABLE VII  
THDi AND THDv FOR NETWORK 1 WITH DIFFERENT SSE GOAL

Testing Case	Estimated signal SSE 0.02		Estimated signal SSE 0.01		Estimated signal SSE 0.005	
	THDi %	THDv %	THDi %	THDv %	THDi %	THDv %
7	4.413	0.919	5.374	0.167	4.208	0.216
8	0.570	0.251	0.288	1.206	1.391	1.791
9	0.611	0.400	0.604	0.053	0.195	0.014
10	1.275	0.041	1.696	0.312	0.882	0.043
11	1.174	0.209	1.275	0.068	0.900	0.018
12	0.213	0.138	0.238	0.391	0.124	0.091
13	0.440	0.140	0.261	0.540	1.136	0.095
14	10.582	0.915	6.947	1.823	9.434	2.088
15	3.722	1.466	2.808	2.438	5.520	2.535
16	1.021	0.973	1.012	2.500	1.899	3.653
17	7.089	0.737	6.882	0.030	5.992	0.095
18	2.518	0.080	1.249	1.048	2.282	1.693
Average	2.802	0.522	2.386	0.881	2.830	1.028

From Table VII we notice the following for the tested estimated signals.

- At SSE=0.02 THDi exceeds only the allowable limit by the IEEE 519-1992 [8] at case 14 & case 17 with max. of 10.58% but the average was 2.802% while THDv is less than 1% for most of the cases except case 15 and the average of all cases was 0.522%.
- At SSE=0.01 THDi exceeds only the IEEE 519-1992 at case 7, case 14 & case 17 with max. of 6.94% but the average was 2.386% while THDv is only max. 2.5% at case 16 and the average of all cases was 0.881%.
- At SSE=0.005 THDi exceeds only the IEEE 519-1992 at case 14 & case 17 with max. of 9.434% but the average was 2.83% while THDv is max. of 3.65% at case 16 and the average of all cases was 1.028%.

According to the above results, the best sum squared error for this neural network was SSE=0.01 from the THD point of view for the estimated fundamental currents and voltages.

While for case 16 with the highest THDi of 57.66% the estimated fundamental current THD is less than 2%.

Fig. 4 shows the input and the estimated current wave form and the FFT and also the extracted harmonic contents from the input for case 16 based on network 1 with goal SSE=0.01.

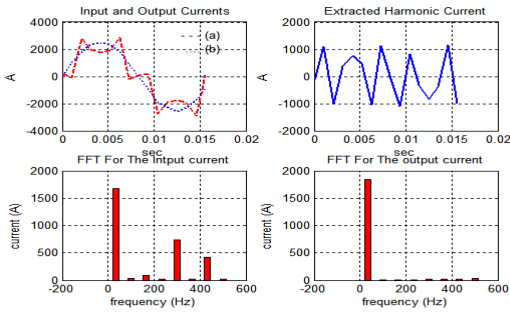

Fig. 4 Current wave form and FFT for case 16 network 1

Fig. 5 shows the input and the estimated voltage wave form and FFT. The extracted harmonic contents from input is also shown for case 16 based on network 1 with goal SSE=0.01 as highest THDv.

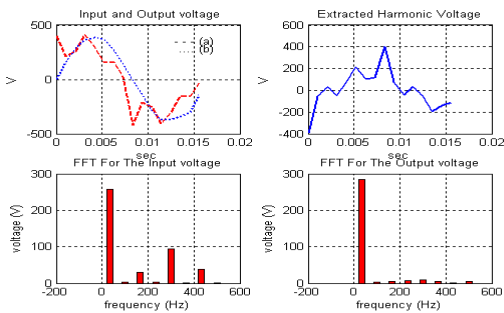

Fig. 5 Voltage wave form and FFT for case 16 network 1

2. Testing for Neural Network 2

Neural network 1 is consisting of the following layers:

Input = 32

Hidden 1 = 21      Hidden 2 = 14

This network has been tested with the 12 cases shown in Table V to achieve a min. THDi and THDv with different Sum squared Error Goal (SSE) as shown in Table VIII at each time we calculate the THDi and THDv for the estimated signal.

TABLE VIII

THDI AND THDV FOR NETWORK 2 WITH DIFFERENT SSE GOAL

Case	Estimated signal		Estimated signal		Estimated signal	
	SSE 0.02		SSE 0.01		SSE 0.005	
	THDi %	THDv %	THDi %	THDv %	THDi %	THDv %
7	2.907	1.407	4.745	0.067	1.868	0.126
8	0.664	2.617	0.283	0.433	0.837	1.457
9	0.020	0.373	0.498	0.593	0.215	0.162
10	0.409	0.199	1.065	0.954	0.249	0.291
11	0.375	0.216	0.712	0.295	0.304	0.071
12	0.420	1.145	0.143	0.147	0.119	0.170
13	1.116	1.237	0.099	0.573	0.435	0.422
14	7.329	2.133	7.092	1.950	1.858	2.303
15	3.198	3.477	0.930	2.319	0.692	3.505
16	0.961	4.716	0.705	1.995	1.001	2.704
17	4.538	0.247	5.952	0.073	2.387	0.440
18	1.557	2.986	1.463	1.278	1.005	1.075
Average	1.958	1.729	1.974	0.890	0.914	1.061

From Table VIII we notice the following for the tested estimated signals.

- At SSE=0.02 THDi exceeds only the allowable limit by the IEEE 519-1992 [8] at case 14 with max. of 7.329% but the average was 1.958% while THDv is only max. 4.716% at case 16 which still do not exceeds the allowable limits and the average of all cases was 1.729%.
- At SSE=0.01 THDi exceeds only the IEEE 519-1992 at case 14 & case 17 with max. of 7.092% but the average was also 1.974% while THDv is only max. 2.319% at case 15 and the average of all cases was 0.890%.
- At SSE=0.005 THDi do not exceeds the IEEE 519-1992 for any of the 12 cases with max. of 2.387% but average was 0.914% while THDv is max. of 3.505% at case 15 and average of all cases was 1.061%.

According to the above results, the best sum squared error for this neural network was SSE=0.005 from the THD point of view for the estimated fundamental currents and voltages.

While for case 17, the estimated fundamental signals of the highest THDi and THDv still do not exceed the IEEE 519-1992.

Fig. 6 shows case 17 input and estimated current wave form and FFT. Also the extracted harmonic contents from input signal based with SSE=0.005 goal.

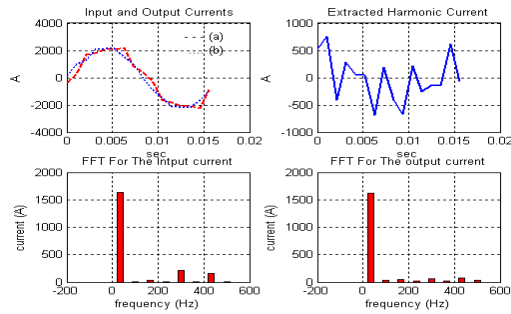

Fig. 6 Current wave form and FFT for case 17 network 2

Fig. 7 shows case 15 input and the estimated voltage wave form and FFT. Also the extracted harmonic contents from input signal with SSE=0.005 goal as highest THDv.

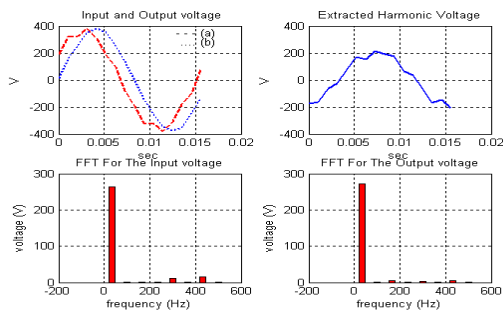

Fig. 7 Voltage wave form and FFT for case 15 network 2

3. Testing for Neural Network 3

Neural network 1 is consisting of the following layers:

Input = 32

Hidden 1 = 18

Hidden 2 = 12

This network has been tested with the 12 cases shown in Table V to achieve a min. THDi and THDv and with different Sum squared Error Goal (SSE) as shown in Table IX at each time we calculate the THDi and THDv for the estimated signal.

TABLE IX

THDI AND THDV FOR NETWORK 3 WITH DIFFERENT SSE GOAL

Case	Estimated signal SSE 0.02		Estimated signal SSE 0.01		Estimated signal SSE 0.005	
	THDi %	THD v%	THDi %	THDv %	THD i%	THDv %
7	4.959	0.093	4.408	0.581	5.442	0.269
8	0.741	1.225	1.155	1.755	0.728	1.016
9	0.166	0.426	0.002	0.205	0.164	0.199
10	1.052	0.114	1.271	0.401	1.028	0.269
11	1.027	0.131	0.804	0.307	0.816	0.161
12	0.142	0.022	0.020	0.691	0.406	0.139
13	0.804	0.196	0.951	2.469	0.788	0.465
14	5.215	1.546	5.856	0.786	10.71	1.861
15	3.525	1.902	0.217	0.309	1.275	2.609
16	1.258	2.982	1.781	3.480	1.173	2.220
17	5.444	0.663	5.465	0.989	7.136	0.073
18	2.319	1.920	1.686	1.966	2.182	0.684
Average	2.221	0.935	1.968	1.162	2.654	0.830

From Table IX we notice the following for the tested estimated signals.

- At SSE=0.02 THDi exceeds only the allowable limit by the IEEE 519-1992 [8] at case 14 and case 17 with max. of 5.444% but the average was 2.221% while THDv is only max. 1.92% at case 18 which still do not exceed the allowable limits and the average of all cases was 0.935%.
- At SSE=0.01 THDi exceeds only the IEEE 519-1992 at case 14 with max. of 5.856% but the average was also 1.968% while THDv is only max. 3.48% at case 16 and the average of all cases was 1.162%.
- At SSE=0.005 THDi exceeds only the allowable limit by the IEEE 519-1992 [8] at case 17 with max. of 7.136% but the average was 2.654% while THDv is max. of 2.609% at case 15 and the average of all cases was 0.830%.

According to the above results, the best sum squared error for this neural network was SSE=0.02 from the min. THD point of view for the estimated fundamental currents and voltages.

While for case 17, the estimated fundamental signal of the highest THDi exceeded a little bit the standard, whereas case 18, the estimated fundamental signal of the highest THDv still does not exceed the IEEE 519-1992.

Fig. 8 shows case 17 input and the estimated current wave form and FFT. Also the extracted harmonic contents from input signal based on network 3 with SSE=0.02 goal.

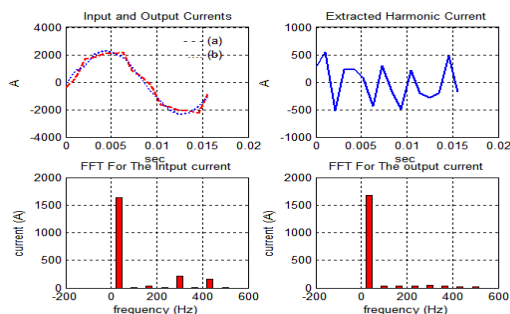

Fig. 8 Current wave form and FFT for case 17 network 3

Fig. 9 shows case 18 input and the estimated voltage wave form and FFT. Also the extracted harmonic contents from input signal based on network 3 with SSE=0.02 goal for highest THDv.

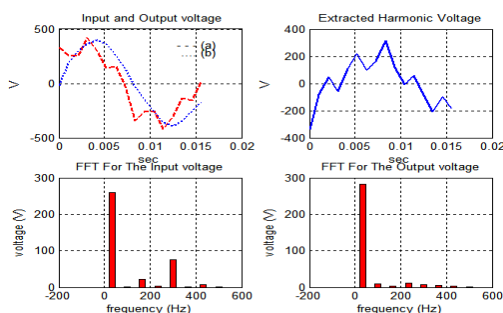

Fig. 9 Voltage wave form and FFT for case 18 network 3

VI. COMPARISON BETWEEN THE THREE NETWORKS

From the analysis at section V we find that the proposed scheme based on the Multi Layer Artificial Neural Network (ML-ANN) gives different results with the three networks applied to the test system and also with different sum squared error goal. Each network configuration and size can give a min. THD for the estimated current waveform but may not give the same best results for the estimated voltage. Figs. 10 to 15 show the comparisons between the three networks with different SSE goal for the estimated current and voltage at all the tested system.

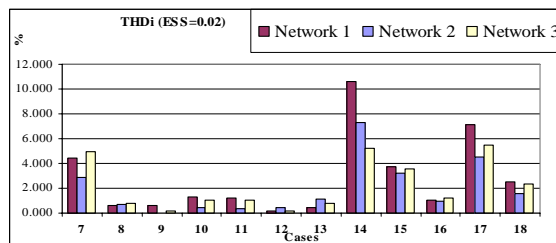

Fig. 10 THDi comparison between the 3 networks at SSE=0.02



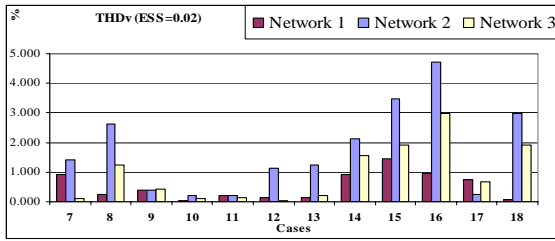

Fig. 11 THDv comparison between the 3 networks at SSE=0.02

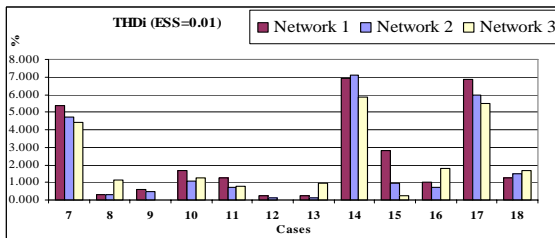

Fig. 12 THDi comparison between the 3 networks at SSE=0.01

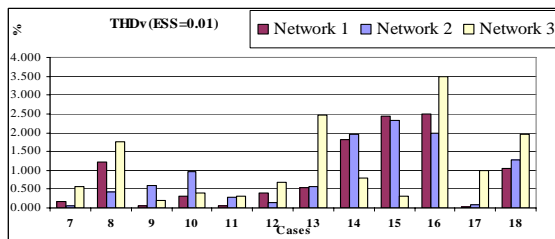

Fig. 13 THDv comparison between the 3 networks at SSE=0.01

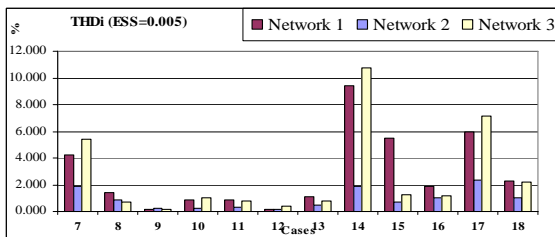

Fig. 14 THDi comparison between the 3 networks at SSE=0.005

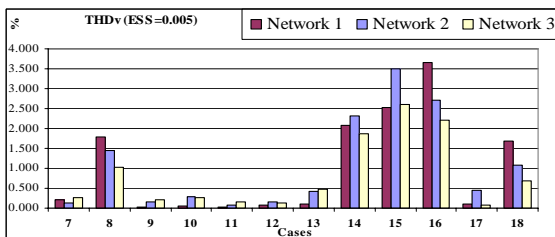

Fig. 15 THDv comparison between the 3 networks at SSE=0.005

From the above comparisons, we find that the max. THD for the estimated current at network 2 with SSE=0.005 was 2.387% which is the min. THDi for all the networks studied with this 13 buses Balanced Industrial Distribution System (BIDS).

We also find that the max. THD for the estimated voltage

was 1.466% at network 1 with SSE=0.02 which is the min. THDv for all the networks with the test system cases.

### VII. CONCLUSION

The analysis and test for the scheme for using one ANN network to estimate the fundamental frequency component for the current and other network for the voltage were very effective and accurate to get the min. total harmonic distortion for the estimated signal.

From this analysis and test for the Multi Layer Artificial Neural Network (ML-ANN) based on industrial distribution system, we can find that there are no guidelines for selecting the optimum (ML-ANN) architecture for a given set of data.

### REFERENCES

- [1] Djaffar Ould Abdeslam, Patrice Wira, Jean Mercklé, Damien Flieller, and Yves-André Chapuis "A Unified Artificial Neural Network Architecture for Active Power Filters" IEEE transactions on industrial electronics, vol. 54, no. 1, February 2007.
- [2] Ramadan El Shatshat, M.M. A. Salama, Fellow, and Mehrdad Kazerani, "Artificial Intelligent Controller for Current Source Converter-Based Modular Active Power Filters" IEEE transactions on power delivery, vol. 19, no. 3, July 2004
- [3] Z. Lu, T. Y. Ji, W. H. Tang and Q. H. Wu "Optimal Harmonic Estimation Using A Particle Swarm Optimizer" IEEE Transactions On Power Delivery, Vol. 23, No. 2, April 2008
- [4] Simone Buso, Luigi Malesani, Paolo Mattavelli and Roberto Veronese "Design and Fully Digital Control of Parallel Active Filters for Thyristor Rectifiers to Comply with IEC-1000-3-2 Standards" IEEE Transactions On Industry Applications, Vol. 34, NO. 3, May/June 1998
- [5] T. Huang, and A.S. Mohan, "A Hybrid Boundary Condition for Robust Particle Swarm Optimization" IEEE Antennas and Wireless Propagation Letters, Vol. 4, pp. 112-117, 2005.
- [6] IEEE Standard 399-1997, "IEEE Recommended Practice for Industrial and Commercial Power System Analysis", IEEE, New York, 1997.
- [7] H.E. Mostafa, M.M. Fawzy, and M.M. Mansour, "ANN Correction of CT Distorted Secondary Current With and Without Remanence" the 6th Regional Conference for National Committees of CIGRE in Arab Countries, Vol. 1, PP. 168-175, Nov. 2005.
- [8] IEEE Standard 519-1992, "IEEE recommended practice and requirements for harmonic control in electrical power systems".
- [9] Transmission & Distribution Committee IEEE Power Engineering Society "Test Systems for Harmonics Modeling and Simulation", IEEE Transactions on Power Delivery, Vol. 14, No. 2, April 1999
- [10] IEEE Task Force on Harmonics Modeling and Simulation. "Modeling and Simulation of the Propagation of Harmonics in Electric Power Networks, Part 1 & 2", IEEE Trans. On Power Delivery, Vol. 11, No. 1 January 1996, pp. 452-474.