

Structure of Linkages and Cam Gear for Integral Steering of Vehicles

Petre Alexandru¹, Dragos Macaveiu², and Catalin Alexandru³

Abstract—This paper addresses issues of integral steering of vehicles with two steering axles, where the rear wheels are pivoted in the direction of the front wheels, but also in the opposite direction. The steering box of the rear axle is presented with simple linkages (single contour) that correlate the pivoting of the rear wheels according to the direction of the front wheels, respectively to the rotation angle of the steering wheel. The functionality of the system is analyzed – the extent to which the requirements of the integral steering are met by the considered/proposed mechanisms. The paper highlights the quality of the single contour linkages, with two driving elements. Cam variants are analyzed and proposed for the rear axle steering box. Cam profiles are determined by various factors.

Keywords—Cam gear, four wheel drive, integral steering, linkage.

I. INTRODUCTION

IN the theory/practice of vehicles it is well known that the steering radius for vehicles with two steering axle are $r_{v_2} < r_{v_1}$ at the pivoting of the front/rear wheels in opposite directions (Fig. 1.a), respectively the radius $r_{v_3} > r_{v_1}$ for pivoting in the same direction (Fig. 1.b),

$$r_{v_1} = \frac{L_a}{\text{tg}\theta_f}, r_{v_2} = \frac{L_a}{\text{tg}\theta_f + \text{tg}\theta_s},$$

$$r_{v_3} = \frac{L_a}{\text{tg}\theta_f - \text{tg}\theta_s}.$$
(1)

where: L_a - axle base, distance between vehicle axles, $\theta_{f,s}$ - the front/rear wheel steering angle, O_v - the turning center.

As the pivoting of the rear wheels in opposite direction to the front wheels – for increasing the maneuverability – lowers the vehicle's stability [2], there have been attempts to achieve “integral steering”, which is intended to be an optimal compromise: during the steering of the vehicle in one direction, the rear wheels can be pivoted in the same direction to the front ones as well as in the opposite direction.

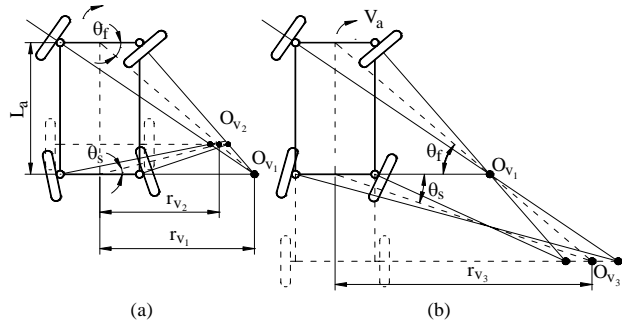

Fig. 1 Vehicle steering with two steering axle

As the stability is a crucial parameter for modern high-speed vehicles, we assume that the vehicle enters the curve at high speed, and during the steering, the turn radius, as well as the speed, are reduced.

Thus, in the beginning section of steering, the rear wheels – for a good stability – should pivot in the same direction to the front ones; if the steering angle increases, rear wheels should return to the neutral position and then to be pivoted in the opposite directions to the front ones – thus, reducing the turning radius. This pivoting system is referred to as “integral steering”.

According to the “integral steering”, the front/rear pivoting functions in relation to the steering wheel rotation angle ϕ_v were presented as in Fig. 2 (numerical values are indicative [1]).

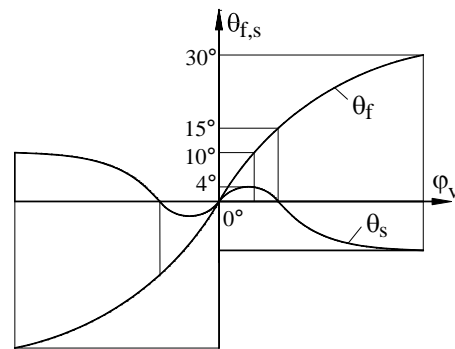

Fig. 2 The steering functions for integral steering.

If the drive of the rear axle steering system is performed mechanically, a longitudinal shaft 4 (driven by the front axle rack) would drive a crank 1 through gears, which, through a linkage, would move the central guiding mechanism 3 (Fig. 3.a) or the central lever 3 (Fig. 3.b) of the steering mechanism from the rear axle.

¹ P. Alexandru, professor at “Transilvania” University of Brasov, Romania (email: palexbv@yahoo.com)

² D. Macaveiu, PHD student at “Transilvania” University of Brasov, Romania (email: dragosmacaveiu@yahoo.com)

³ C. Alexandru, professor at “Transilvania” University of Brasov, Romania (email: cal Alexandru.bv@gmail.com)

Acknowledgments. The paper is supported by CNCS – UEFISCDI, project PNII-IDEI 607/2008.

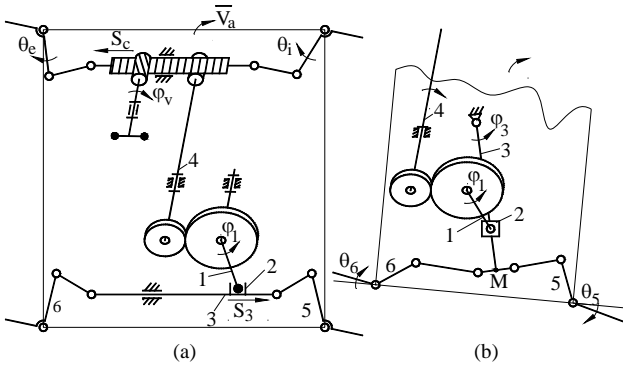

Fig. 3 The rear axle steering system with linkages

Next, the considerations that are made will not be on the angular functions $\theta_{e,i}(\varphi_v)$ concerning the front axle steering mechanism, the transmitting front/back function $\varphi_1(\varphi_v)$ or pivoting function $\theta_{5,6}(\varphi_3/S_3)$ of the rear axle steering mechanism, but only on the function $\varphi_3(\varphi_1)$ or $S_3(\varphi_1)$ the characteristic “integral steering” mechanism.

II. LINKAGES FOR INTEGRAL STEERING

Obtaining the functions $\theta_s(\varphi_v)$ or $\theta_s(\theta_f)$ according to Fig. 2, is a very difficult task that requires, not only the imposition of a swing movement with different amplitudes to a central lever 3 or a rack 3, but also actions’ symmetry for left or right steering of the vehicle.

Various types of linkages for operating the lever/rack are proposed in paper [6], [7], but without tangible result for their position. Variants that are acting through cams are proposed in papers [3], [5], without a concrete result of cams profiling.

The simple mechanisms with one contour from Fig. 4, where crank 1 receives the movement from longitudinal shaft 4, can achieve a backward-and-forward motion of the central element 3, this mean that these mechanisms can be used for the rear steering box.

To achieve symmetry for left / right pivoting, these mechanisms should be designed so that - at the initial position - crank 1 is along the base OB, at going straight (namely $\varphi_v = 0, \theta_{f,s} = 0$).

The function $S_3(\varphi_v)$ will have to follow the function $\theta_s(\varphi_v)$ from Fig. 2, for steering in the same or opposite direction.

Therefore, if the RRTR mechanism from Fig. 4.a, has the initial position of crank \overline{OA} along the line OB (position 1, Fig. 5.a₁) then, going through interval 1 – 2 – 3 – 4 in a counter-clockwise direction, $S_3 = r \sin \varphi_1$ shape, represented in the drawing, is achieved. For placing the crank in superior position (Fig. 5.a₂) as its initial position, going through positions 1 – 2 – 3 – 4 will be made clockwise; with angle $\varphi_1[0, 270^\circ]$ in both cases to obtain a shape similar to $\theta_s(\varphi_v)$ in Fig. 2. As this mechanism is defined geometrically by a single parameter, the crank’s radius r, it is difficult to optimize from functional point of view, being shown here only as an image.

For the RRTR guiding mechanism from Fig. 4.b, to which $S_3 = l \sin \varphi_3, \varphi_3(\varphi_1)$, similarly, the crank OA should initially be positioned along the line OB of the base, inferior (Fig. 5.b₁) or superior (Fig. 5.b₂) position 1 being correlated with the direction of the crank’s rotation. Therefore, from position 1 to 2, the rear wheels will pivot in the direction of the front wheels, followed by returning from position 2 to 3 (when $\varphi_1 = 180^\circ$), and then the rear wheels will pivot in the opposite direction, from position 3 to 4. In position 4, the maximum pivoting is achieved – which corresponds to the angular position $\varphi_1 = 270^\circ - \phi$ for the representation in b₁, respectively $\varphi_1 = 270^\circ + \phi$ for b₂, with the angle $\phi = \arcsin r/b$.

In diagram $\varphi_3(\varphi_1)$ or $S_3(\varphi_1)$, the continuous line corresponds to the positioning in b₁, and the dotted line to the positioning in b₂. The guiding mechanism, geometrically defined by parameters r and b, has two optimization possibilities, especially the interference of the length l of the lever.

Note that the complete drive $\varphi_1 = 270 \pm \phi$ of the crank is obtained at the maximum rotation of the steering wheel in one way or another, which is usually two revolutions (i.e. $\varphi_v = 720^\circ$), therefore the front/rear intermediation through gear is absolutely necessary for achieving the adequate transmitting ratio.

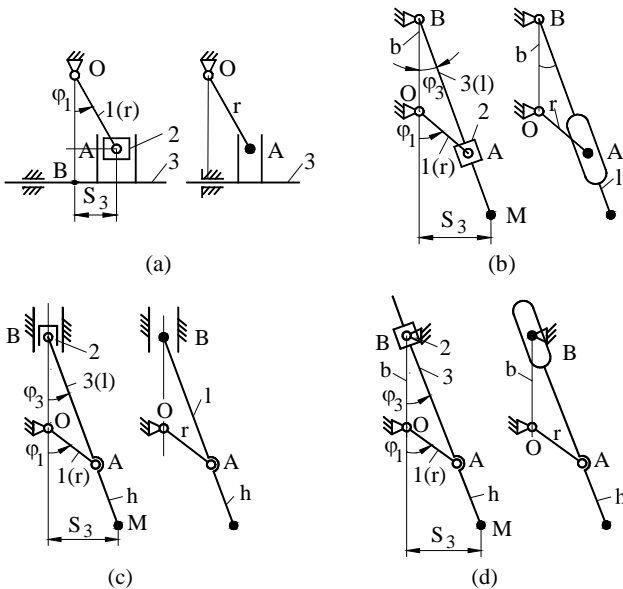

Fig. 4 Single contour mechanism for integral steering

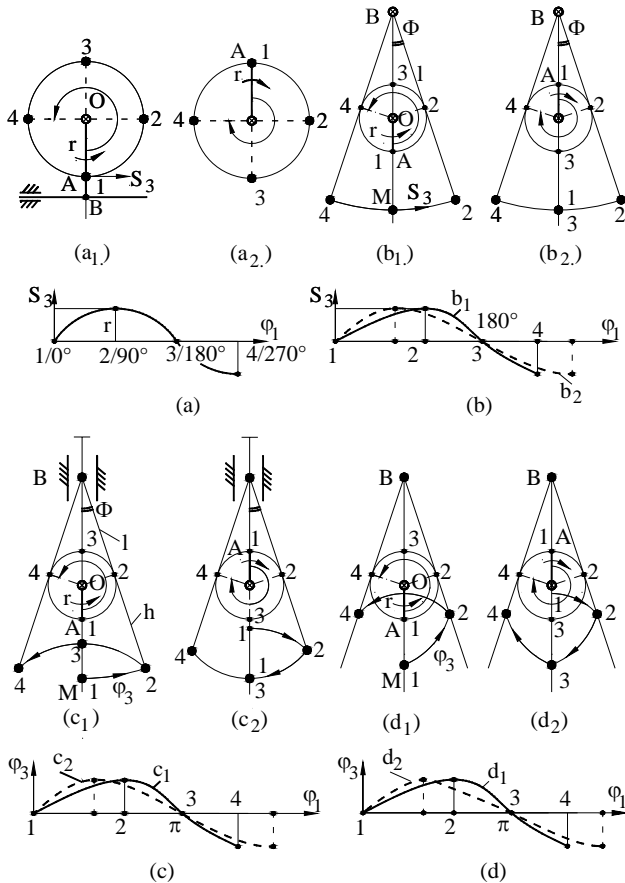

Fig. 5 The functionality of single contour mechanisms for integral steering

Similarly, for the *RRRT slider mechanism* in Fig. 4.c, as for the *RRTR mechanism* in Fig. 4.d, if the initial positioning of the crank *OA* is along the base line *OB* (Fig. 5.c.d), positions 1 – 2 – 3 – 4 of the crank will generate the trajectory of point *M* through points 1 – 2 – 3 – 4, respectively the functions $\varphi_3(\varphi_1)$ indicated on the drawing. The displacement of the characteristic point *M* on the direction *OB* is a drawback, the variant with guiding mechanism (Fig. 5.b) can be regarded as preferable.

The main shortcomings of these simple mechanisms within integral steering are caused by the fact that, although the shape of the function $\theta_s(\varphi_v)$ is achieved, in terms of numeric values, the mechanisms don't meet the requirements. Thus, these mechanisms:

- generate identical values of the races 1 – 2 and 3 – 4 (same/opposite direction related to the front wheels), with negative effects on the maneuverability.
- the first part of the race 1 – 2 – 3 (same direction to the front wheels) is done on an excessively large angle rotation of the crank compared to the angle of pivoting in the opposite direction, also with negative consequences on vehicle maneuverability.

However, the simple mechanisms in Fig. 4 remain as solutions for the integral steering, the shape and values $S_3(\varphi_1)$ could overlap the required function $\theta_s(\varphi_v)$ if a displacement on the race direction of the linkage from the mechanism base is introduced; as such, a mechanism with two driving elements is considered.

Therefore, for *RRTT sine mechanism* in Fig. 4.a – with the positioning as in Fig. 5.a – slider 7 (Fig. 6.a) is inserted, the slider that shifts the center *O* successively from position O_1 to positions O_2, O_3, O_4 . In this way the trajectory of joint *A* will be a non-circular one, the stroke for the mechanism being

$$S_3 = r \sin \varphi_1 - S_7. \tag{2}$$

The judiciously correlation of cinematic parameters φ_1 / S_7 will lead to obtaining the desired function $S_3(\varphi_1)$.

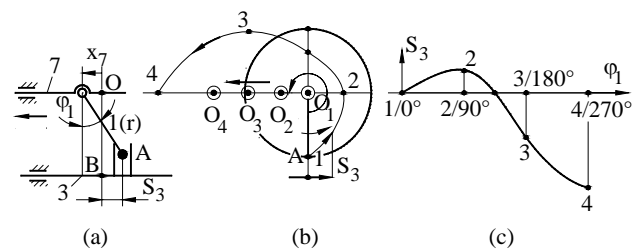

Fig. 6 RRTT mechanism with two driving elements (TRRTT)

For the *RRTR guiding mechanism* in Fig. 4.b – with the positioning as in Fig. 5.b – by inserting the guiding mechanism 7, that shifts the joint *B* (Fig. 7.a) from position B_0 successively in positions $B_{1, 2, 3, 4, 5}$, simultaneous with the rotation of joint *A* from position A_0 in $A_{1, 2, 3, 4, 5}$ (Fig. 7.b), the displacement of point *M* can be obtained. Obviously, the displacement x_M is according to both parameters φ_1 / x_B , the mechanism – although it has two driven elements (1 and 7) – works with their correlation. The displacement of the characteristic point becomes

$$x_M = r \sin \varphi_1 + (l - S_2) \sin \varphi_3, \tag{3}$$

where:

$$S_2 = AB = \sqrt{r^2 + x_B^2 + b^2 - 2rx_B \sin \varphi_1 - 2rb \cos \varphi_1}, \tag{4}$$

$$\varphi_3 = \arctg \frac{r \sin \varphi_1 - x_B}{b - r \cos \varphi_1}.$$

The two geometric parameters *r* and *b*, to which the length *l* of the rod 3 is added, as well as the correlation of the input cinematic parameters φ_1 / x_B , make the function $x_M(\varphi_1)$ to have both the shape and the numerical values meeting the requirements of integral steering (Fig. 7.c).

For the *RRRT slider mechanism* in Fig. 4.c – with the position as in Fig. 5.c – the translation of the slider (Fig. 8.a) simultaneous with the crank rotation, requires the correlation of $B_0 \rightarrow B_{1, 2, 3, 4, 5, 6}$ with $A_0 \rightarrow A_{1, 2, 3, 4, 5, 6}$. In this way, the trajectory of point *M* trough points 0 – 6 will generate a similar displacement x_M as in the previous case (Fig. 8.b).

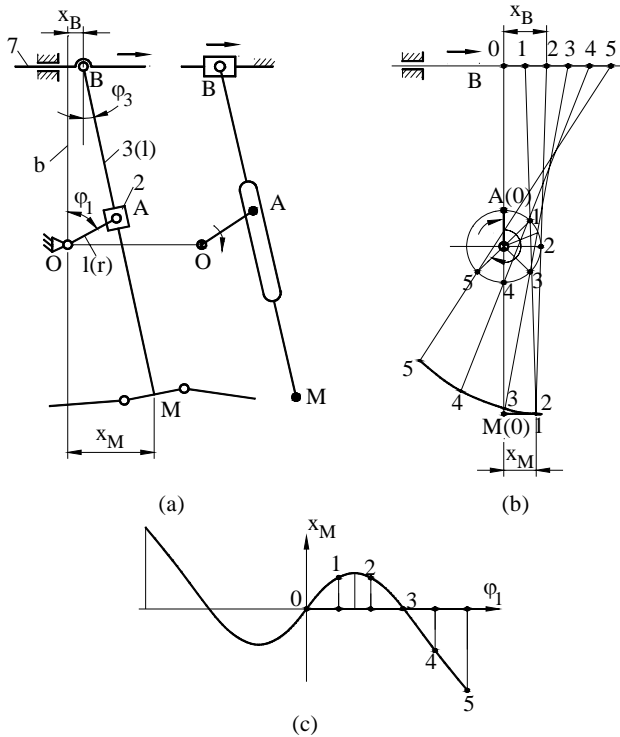

Fig. 7 The RRTR mechanism with two driving elements (RRTRT)

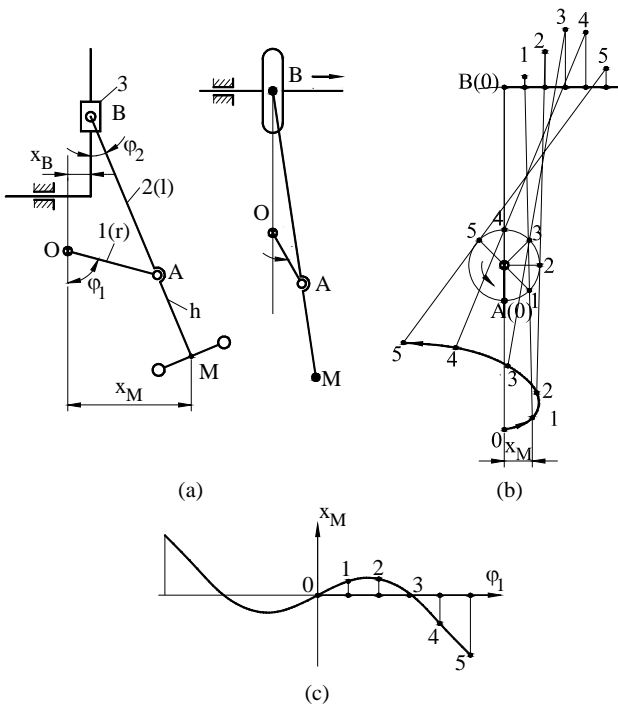

Fig. 8 The RRRT mechanism with two elements (RRRTT)

Thus:

$$x_M = r \sin \varphi_1 + h \sin \varphi_2, \quad (5)$$

where:

$$\sin \varphi_2 = \frac{r \sin \varphi_1 - x_B}{l}. \quad (6)$$

Even the 4R linkage (Fig. 9.a), by moving the joint B of the rocker, can achieve the function x_M required by integral steering, an imposed correlation existing between φ_1 and x_B . Therefore, starting from initial position $OA_1C_1B_1$, by shifting $B_{(1-2, 2-3, 3-4)}$ and $A_{(1-2, 2-3, 3-4)}$, the displacement $x_M(\varphi_1)$ is achieved from the trajectory of point M, as in Fig. 9.b.

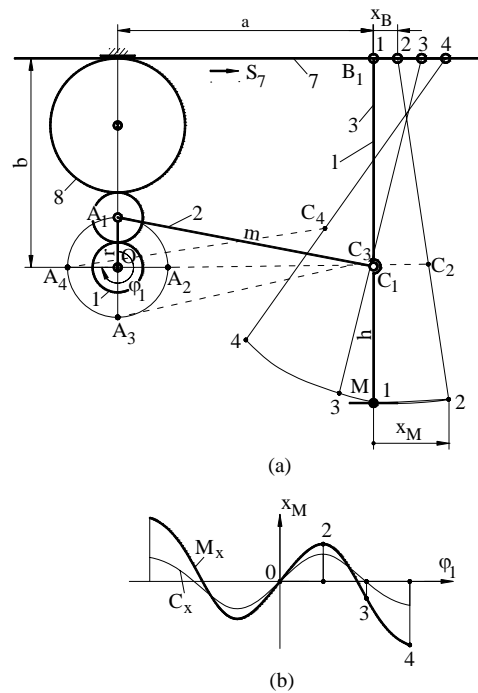

Fig. 9 The 4R linkage with two driving elements (RRRTT)

The correlation of the two inputs φ_1/S_7 is made by gears with appropriate ratio, for example the ratio $A_1\hat{A}_2/B_1B_2$ is interpreted by the ratio between the radii of the crank and pinion r/r_1 .

As the chart of this mechanism is defined by 5/6 geometrical parameters a, b, r, m, l and h , their optimal combination and the ratio r/r_1 , will lead to the desired shape of displacement $x_M(\varphi_1)$.

III. CAM GEAR FOR INTEGRAL STEERING

The possibility for cam gears to precisely achieve complex laws of motion is very high, therefore their use in rear axle steering box is a gain.

Longitudinal shaft 4 (v. Fig. 3) can drive the cams directly from the front axle, and the cams can drive a translational slider or a rotational slider (having the role of a cam follower).

In Fig. 10, V_a – vehicle speed, I – steering to the right, II – steering to the left. For steering to the right - I, slider 5 positioned in the right side of the cam (Fig. 10.a₁), in point 1 on the circle with the radius r_0 - which marks the position for rectilinear movement of the vehicle. If the cam is rotated clockwise, then, for the rear wheels to pivot first to the direction of the front wheels (to the right), slider 5 needs to move away from the center of the cam, therefore the cam needs a profile 1 – 2 outside of the circle with the radius r_0 . This is followed by the returning profile 2 – 3 from which the rear wheels can be steered to the left, therefore slider 5 should move to the left, which means a profile 3 – 4 for moving closer to the center of the cam. Thus, the cam profile 1 – 2 – 3 – 4 for steering to the right is obtained.

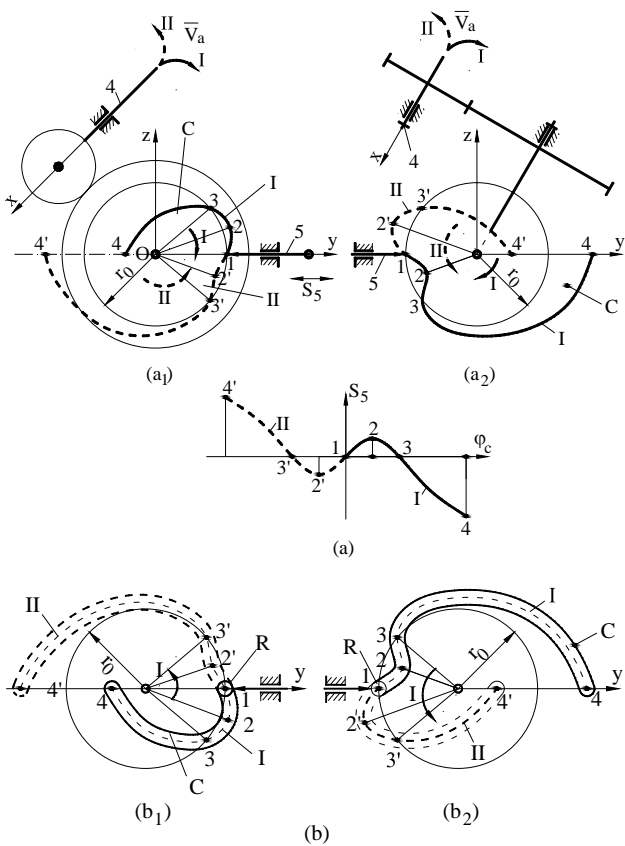

Fig. 10 The arrangement of cam profiles that are rotated by 180°

For steering to the left – II, the cam being rotated counterclockwise, slider 5 needs to move to the left, on profile 1' – 2' followed by the returning profile 2' – 3' (profiles inside the circle with the radius r_0); then, the rear wheels are steered in the opposite direction to the front wheels (to the right), which means that slider 5 is moving to the right – following the profile 3' – 4' that is outside the circle with the radius r_0 . Thus, the profile of the cam 1' – 2' – 3' – 4' for steering to the left is obtained. By connecting the contours 1 – 2 – 3 – 4/1' –

2' – 3' – 4', the complete profile of the cam will be obtained, but indicating that the angle of rotation of the cam in each direction was considered as being 180° and the contact on the profile being on the “right” side.

Under the same conditions of steering I/II and rotation of the cam I/II (clockwise/counterclockwise), but with the cam follower positioned on the “left” side of the cam (Fig. 10. a₂), by the same reasoning a cam profile is obtained, symmetrical to variant 10.a₁ with respect to z-axis, the continuous line showing the profile I/1 – 2 – 3 – 4 for steering to the right and the dotted line showing the profile II/1' – 2' – 3' – 4' for steering to the left.

In case the rotation of the cam for profile I (steering to the right) is counterclockwise and II clockwise (Fig. 10.b), therefore inverse to the previous case, based on the same reasoning, the profile I – II from figures 10.b₁/10.b₂ is obtained, symmetric to contours in 10.a₁/10.a₂ in respect to y-axis (slider axis). In diagram 10.b, the roller R was considered as passing through a profile groove of the cam; in diagram 4.a, being a pointed cam follower.

At a rotation ϕ_c of cam with 90° in one way or another (so with a full profile of the cam in 180°), the complete profile is shown in Fig. 11.a, in terms of 10.a₁ („left” contact, rotation I – clockwise, II – counterclockwise).

Due to the profile symmetry with respect to the z-axis, in case of “left – right” contact, the profile in Fig. 11.a may be completed as shown in Fig. 11.b, where the two contacts can exist simultaneously, so that the structure can become compact [4], [5].

The contact with two rollers is locking cam follower, as shown in Fig. 11.c. The advantage of the structure with two rollers is reduced by the condition of the cam rotation limitation at $\phi_c = 90^\circ$, in one way and the other.

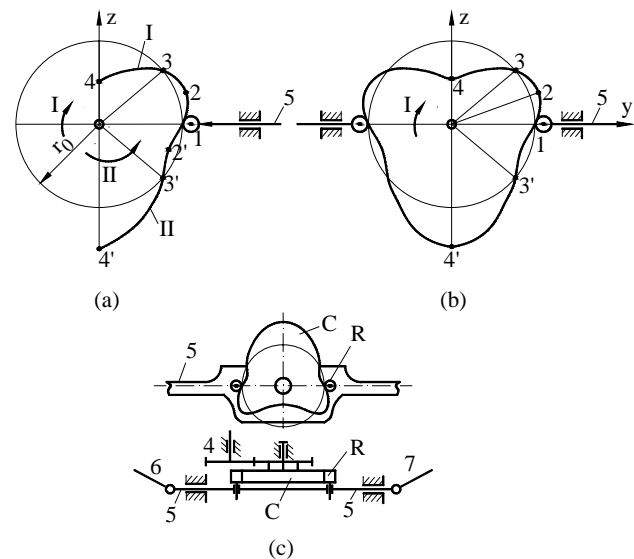

Fig. 11 Arrangement of cam profiles that are rotated by 180°

Considering the rotation I being clockwise for steering to the right, continuous line profiles are identified as active and dotted line profiles as passive, depending on the slider thrust (Fig. 12). Similarly, for the steering to the left - rotation II, with a continuous line are the active contours and the dotted line shows the passive ones. They correspond to the increasing polar radius of the cam for active contours and decreasing polar radius for passive contours.

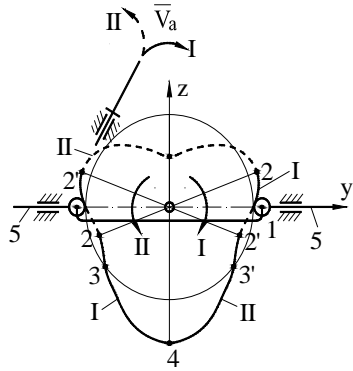

Fig. 12 Active / passive contours of the cam

Such a cam for integral steering may drive not only a translational slider 5, but also a central lever 5 of the rear axle steering mechanism. Central lever can be placed vertically (Fig. 13.a) or horizontal (Fig. 13.b), driving the steering knuckle rods 6 – 7.

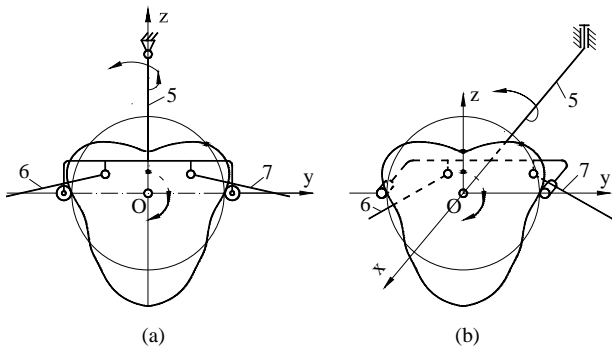

Fig. 13 Cam linkages – floating cam follower for integral steering

An imposed law for cam profiling can be given directly as a displacement law of the slider cam follower: to the circle with radius r_0 a function is added or subtracted – for example the sine on cycle $0 - \pi$ (contour 1 – 3), followed by an addition or subtraction – also a sine function on cycle $0 - \pi/2$ (contour 3 – 4).

As a numerical application, the sine displacement law is considered

$$S_{1-3} = a_1 \sin \frac{\pi}{\varphi_a} \varphi_c, S_{3-4} = a_2 \sin \frac{\pi}{2\varphi_b} \varphi_c, \quad (7)$$

$$\varphi_b = \frac{\pi}{2} - \varphi_a$$

where φ_a is the cam rotation angle of the first cycle, φ_b - the second cycle, and φ_c - the current angle of rotation (see Fig. 8).

The following values are considered for the application:

$$r_0 = 40 \text{ mm}, a_1 = 8 \text{ mm}, a_2 = 32 \text{ mm}, \varphi_a = 20^\circ, \varphi_b = 70^\circ.$$

The polar radii of the cam are given by:

$$r_I = r_0 + S_{1-3}, \text{ respective } r_I = r_0 - S_{3-4} \text{ for profile I (1 - 2 - 3 - 4);}$$

$$r_{II} = r_0 - S_{1-3}, \text{ respective } r_{II} = r_0 + S_{3-4} \text{ for profile II (1 - 2' - 3' - 4').}$$

The cam representation – for the cam follower with two rollers and $\phi_c = 90^\circ$ in one direction and the other is given in Fig. 15.a; the rotation I of the cam is counterclockwise for steering to the right.

For the cam follower with a single roller, accepting $\phi_c = 180^\circ$ in one direction and the other, the cam in Fig. 15.b is obtained, angle cycles being doubled if compared to previous case,

$$\varphi_a = 40^\circ, \varphi_b = 140^\circ,$$

the rest of the data remaining the same, as well as the resulting values (at angles $\varphi_c = 0^\circ, 10^\circ, 20^\circ, 30^\circ, 40^\circ$ and $20^\circ/60, 40^\circ/80, 60^\circ/100, 80^\circ/120, 100^\circ/140, 120^\circ/160, 140^\circ/180$).

TABLE I
NUMERICAL CALCULATIONS

φ_c	0°	5°	10°	15°	20°	$10^\circ/30$	$20^\circ/40$	$30^\circ/50$	$40^\circ/60$	$50^\circ/70$	$60^\circ/80$	$70^\circ/90$
S_{1-3}	0	5.65	8	5.65	0	-	-	-	-	-	-	-
S_{3-4}	-	-	-	-	-	7.10	13.85	19.93	25.08	28.83	31.20	32
r_{II}	40	34.35	32	34.35	40	47.10	53.85	59.93	65.08	68.83	71.2	72
r_I	40	45.65	48	45.65	40	32.90	26.15	20.07	14.92	11.17	8.80	8

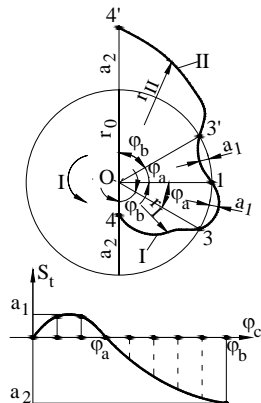

Fig. 14 Phases of cam movement.

IV. CONCLUSIONS

The simple single contour linkages, for achieving the symmetries of the left/right steering of the vehicle, need the crank in the initial position (for going straight) to be placed along the base.

The simple linkages (with the crank positioned along the base) can achieve the function shape of integral steering, but not its functional numeric requirements.

The linkages to which an additional slider is added for shifting a joint (i.e. mechanism DOF=2), become solutions that fully answer the requirements of integral steering.

The mechanisms with two driving elements, require the correlation of the driving elements, so that the final structure has DOF=1.

Cams for the rear axle steering box have different profiles for steering to the left and right, both profiles having the polar radii superior and inferior to the radius r_0 for going straight.

The cam profile is determined by the imposed law, such as the direction of cam rotation in relation to the steering direction and the maximum angle of rotation of the cam.

REFERENCES

- [1] Alexandru, P., Alexandru, C. *Mechanisms for the integral steering*. 12th EAEC – European Automotive Congress, Bratislava, 2009, pp. 99.
- [2] Berkefeed, V., Seifort, G. *Four wheel steering – handling and disturbance compensation on surface with various friction condition*. SAE Papers no. 925051.
- [3] Galtier, L. *Rear steering control device for automotive vehicle with four – wheel steering*. United State Patent nr. 4.993.730.
- [4] Kido, L. *Steering mechanism for vehicle rear wheels*. U.S. Patent no. 4.943.074.
- [5] Lupo, G. *Mechanical steering device for rear wheels*. United State Patent no. 4.953.881.
- [6] Sano, S. *Vehicular steering system*. United State Patent no. 4.522.416.
- [7] Viscoti, M. *Steering device for a motor vehicle with four steered wheels*. U.S. Patent no 4.984.815

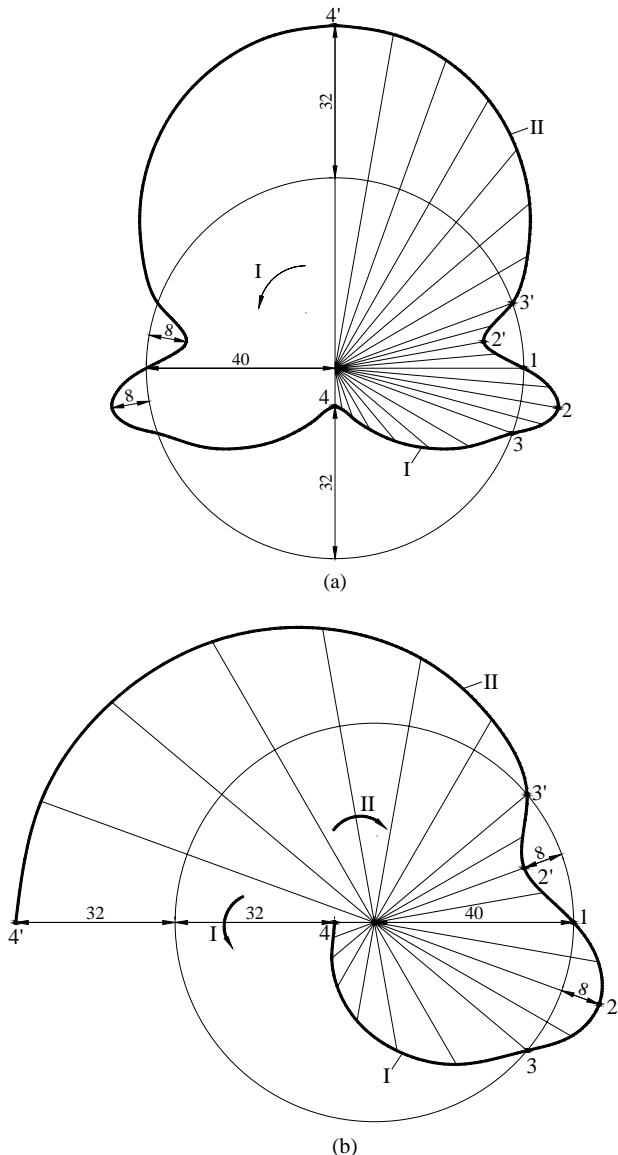

Fig. 15 Numerical application for cam profile