

Speed Sensorless Direct Torque Control of a PMSM Drive using Space Vector Modulation Based MRAS and Stator Resistance Estimator

A. Ameer, B. Mokhtari, N. Essounbouli, L. Mokrani

Abstract—This paper presents a speed sensorless direct torque control scheme using space vector modulation (*DTC-SVM*) for permanent magnet synchronous motor (*PMSM*) drive based a Model Reference Adaptive System (*MRAS*) algorithm and stator resistance estimator. The *MRAS* is utilized to estimate speed and stator resistance and compensate the effects of parameter variation on stator resistance, which makes flux and torque estimation more accurate and insensitive to parameter variation. In other hand the use of *SVM* method reduces the torque ripple while achieving a good dynamic response. Simulation results are presented and show the effectiveness of the proposed method.

Keywords—*MRAS*, *PMSM*, *SVM*, *DTC*, Speed and Resistance estimation, Sensorless drive

I. INTRODUCTION

A C motor control has attracted much attention recently in the power electronics field [1]. Permanent magnet synchronous motors (*PMSM*) have been widely used as servomotors over the last two decades. In recent years, they are used more in the variable speed applications due to some advantages like: more simplicity, low dependency on the motor parameters, good dynamic torque response, high rate torque/inertia [2] Since the advent of the direct torque control (*DTC*) for induction machines in the 1980's as proposed by M. Depenbrock [1] and Takahashi [3], its research has been becoming ever more prevalent in the society. The main advantages of *DTC* are the simple control scheme, a very good torque dynamic response, as well as the fact that it does not need the rotor speed or position to realize the torque and flux control, moreover *DTC* is not sensitive to parameters variations (except stator resistor) [1]-[5].

However, it still has some disadvantages that can be summarized in the following points:

- Difficulty variable switching frequency,
- High current and torque ripple;
- High sampling frequency needed for digital
- Implementation of hysteresis comparators.
- High noise level at low speed [3];

A. Ameer is with Materials Laboratory (LeDMaScD), Amar Telidji University, BP 37G, Ghardaia Street, Laghouat, Algeria, (fax: +213 (0) 29 93 26 98); e-mail: amaissa1@yahoo.fr).

B. Mokhtari is with Materials Laboratory (LeDMaScD), Amar Telidji University, Laghouat, Algeria, e-mail: mokhtari71@yahoo.fr).

N. Essounbouli is with Center of Research in Science and Technologies of Information and Communication, Reims University, 10026 Troyes CEDEX, France. (e-mail: najib.essounbouli@univ-reims.fr).

To overcome the above drawbacks, some researchers have been trying to propose solution to solve these problems by substitute hysteresis control by *fuzzy* control [4]. An effective modality for reducing the torque ripple without using a high sampling frequency is to calculate a proper reference voltage vector that can produce the desired torque and flux values, and then applied to the inverter using space vector modulation (*SVM*) [6]-[9]. This approach is known in the literature as *DTC-SVM*. Even though this control method provides fast torque response and small torque ripples.

The high performance speed or position control requires an accurate knowledge of rotor shaft position and velocity in order to synchronize the phase excitation pulses to the rotor position. This implies the need for speed or a shaft position sensor such as an optical encoder or a resolver. However, the presence of this sensor (expensive and fragile and require special treatment of captured signals), causes several disadvantages from the standpoint of drive cost, encumbrance, reliability and noise problem [6]-[10].

To achieve sensorless operation of a *PMSM* drive, several algorithms have been suggested in recent literature. These methods can broadly be classified as:

- Back-emf based estimators with explicit compensation for nonlinear properties, parameter variation and disturbances.
- Estimation based on high frequency signal injection, exploiting the saliency property of a *PMSM* [3].
- Adaptive or robust observers based on advanced models.

The Method of observers is sometimes more favourable due to its robustness to parameter variations and its excellent disturbance rejection capabilities[7]-[9].

This paper proposes the control strategy using space vector modulation (*DTC-SVM*) based on the *MRAS* (Model Reference Adaptive System) in the sensorless control of a permanent magnet synchronous motor and stator resistance estimation So that it can overcome the problem of sensitivity in the face of motor parameter variation.

II. PMSM MODEL

The stator and rotor flux equation of *PMSM* can be written in the reference frame of Park in the following form [2]:

$$\begin{bmatrix} \phi_d \\ \phi_q \end{bmatrix} = \begin{bmatrix} L_d & 0 \\ 0 & L_q \end{bmatrix} \begin{bmatrix} i_{sd} \\ i_{sq} \end{bmatrix} + \begin{bmatrix} \phi_e \\ 0 \end{bmatrix} \quad (1)$$

While the equations of the stator voltages are written in this same reference frame in the following form:

$$\begin{bmatrix} v_d \\ v_q \end{bmatrix} = r_s \begin{bmatrix} i_{ds} \\ i_{qs} \end{bmatrix} + \begin{bmatrix} L_d & 0 \\ 0 & L_q \end{bmatrix} \frac{d}{dt} \begin{bmatrix} i_{ds} \\ i_{qs} \end{bmatrix} + p\Omega_r \begin{bmatrix} 0 & -L_q \\ L_d & 0 \end{bmatrix} \begin{bmatrix} i_{ds} \\ i_{qs} \end{bmatrix} + p\Omega_r \begin{bmatrix} 0 \\ \phi_e \end{bmatrix} \quad (2)$$

In addition the electromagnetic torque can be expressed:

$$T_e = \frac{3}{2} p ((l_d - l_q) i_{ds} i_{qs} + q_e i_{qs}) \quad (3)$$

The mechanical equation of the motor can be expressed as flows:

$$J \dot{\Omega} = T_e - T_l - f_r \Omega \quad (4)$$

III. CONVENTIONAL DTC

The methods of direct torque control (DTC) as shown in figure 1 consist of directly controlling the turn off or turn on of the inverter switches on calculated values of stator flux and torque from relation (6). The reference frame related to the stator makes it possible to estimate flux and the torque, and the position of flux stator. The aim of the switches control is to give the vector representing the stator flux the direction determined by the reference value.

$$\begin{cases} \phi_{s\alpha} = \int_0^t (v_{s\alpha} - r_s i_{s\alpha}) dt \\ \phi_{s\beta} = \int_0^t (v_{s\beta} - r_s i_{s\beta}) dt \end{cases} \quad (5)$$

The DTC is deduced based on the two approximations described by the formulas (6) and (7) [1],[5]:

$$\bar{\phi}_s(k+1) \approx \bar{\phi}_s(k) + \bar{V}_s T_s \rightarrow \Delta \bar{\phi}_s \approx \bar{V}_s T_s \quad (6)$$

$$T_e = k (\bar{\varphi}_s \times \bar{\varphi}_r) = k |\bar{\varphi}_s| |\bar{\varphi}_r| \sin(\delta) \quad (7)$$

More over:

$$\begin{cases} \hat{\phi}_s = \sqrt{\hat{\phi}_{s\alpha}^2 + \hat{\phi}_{s\beta}^2} \\ \angle \hat{\phi}_s = \arctg \frac{\hat{\phi}_{s\beta}}{\hat{\phi}_{s\alpha}} \end{cases} \quad (8)$$

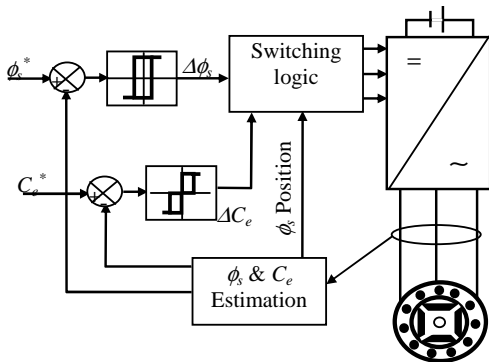

Fig. 1 Diagram of DTC control applied for PMSM supplied with a three-phase inverter with PWM

A two levels classical voltage inverter can achieve seven separate positions in the phase corresponding to the eight sequences of the voltage inverter.

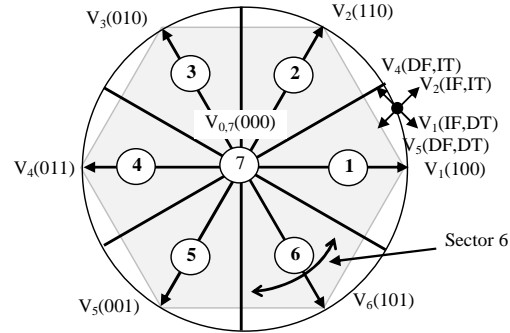

Fig. 2 Different vectors of stator voltages provided by a two levels inverter

Where: I (D)F : Increase (Decrease) of Flux amplitude.
I(D)T : Increase (Decrease) of Torque.

Table I have the sequences corresponding to the position of the stator flux vector in different sectors (see Figures 1).

TABLE I
VECTORS VOLTAGE LOCALIZATION

$\Delta\phi_s$	ΔC_e	S ₁	S ₂	S ₃	S ₄	S ₅	S ₆
	1	110	010	011	001	101	100
1	0	000	000	000	000	000	000
	-1	101	100	110	010	011	001
0	0	000	000	000	000	000	000
	-1	001	101	100	110	010	011

The flux and torque are controlled by two comparators with hysteresis illustrated in Figure 3. The dynamics torque are generally faster than the flux then using a comparator hysteresis of several levels, is then justified to adjust the torque and minimize the switching frequency average [5].

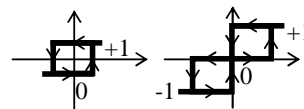

Fig. 3 Comparators with hysteresis used to regulate flux and torque

IV. SPACE VECTOR MODULATION

The Space Vector Modulation (SVM) is not based on separate calculations for each arm of a three-phase voltage inverter but by determination of a reference voltage vector from eight voltage vectors. This is generally calculated and approximated on a modulation period T from a vector average voltage developed by the application of adjacent voltage vectors and zero vectors V₀ and V₇. We note with T_i and T_{i+1} a two-time application of these vectors; their sum must be less than the period T of the inverter switching. The SVM consists in projecting the reference voltage vector on both V_{sref} desired voltage vectors V₁ and V₂ in the first sector and the application time of each adjacent vector is given by [9]:

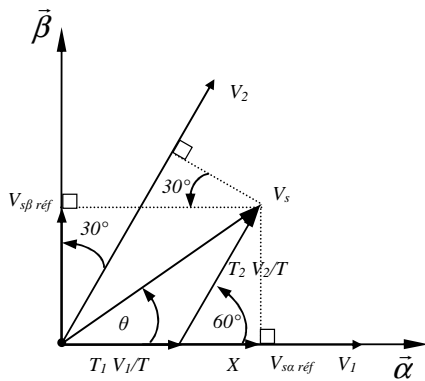

Fig. 4 Projection of the reference Voltage Vector

Where:

T_s : represents the switching period;

T_1 : the time of application of the vector \bar{V}_1 ;

T_2 is the time of application of the vector \bar{V}_2 ;

T_0 : the duration of the sequence of freewheel.

The determination of the amount of times T_1 and T_2 is given by simple projections:

$$\begin{cases} V_{sa} = \frac{T_1}{T} |\bar{V}_1| + x \cos(30^\circ) \\ V_{sb} = \frac{T_2}{T} |\bar{V}_2| \\ x = \frac{V_{sb}}{\tan(60^\circ)} \end{cases} \quad (9)$$

Finally, with the $(\alpha-\beta)$ component values of the vectors given in the Table 4.2,

 TABLE II
 $(\alpha-\beta)$ COMPONENT VALUES OF THE VECTORS VOLTAGE

Vectors	S_a	S_b	S_c	V_{as}	V_{bs}
V_0	0	0	0	0	0
V_5	0	0	1	$\sqrt{2}U_c / \sqrt{3}$	0
V_3	0	1	0	$U_c / \sqrt{6}$	$U_c / \sqrt{2}$
V_4	0	1	1	$-U_c / \sqrt{6}$	$U_c / \sqrt{2}$
V_1	1	0	0	$-\sqrt{2}U_c / \sqrt{3}$	0
V_6	1	0	1	$-U_c / \sqrt{6}$	$-U_c / \sqrt{2}$
V_2	1	1	0	$U_c / \sqrt{6}$	$-U_c / \sqrt{2}$
V_7	1	1	1	0	0

The amount of times of application of each adjacent vector is:

$$\begin{cases} T_1 = \frac{T}{2U_c} (\sqrt{6} \cdot V_{as.ref} - \sqrt{2} \cdot V_{\alpha\beta.ref}) \\ T_2 = \sqrt{2} \frac{T}{U_c} V_{bs.ref} \end{cases} \quad (10)$$

The rest of the period spent in applying the null-vector. For every sector, commutation duration is calculated. The amount of times of vector application can all be related to the following variables:

$$\begin{cases} X = \frac{T}{U_c} \sqrt{2} \cdot V_{bs.ref} \\ Y = \frac{T}{U_c} \left(\frac{\sqrt{2}}{2} \cdot V_{bs.ref} + \frac{\sqrt{6}}{2} \cdot V_{as.ref} \right) \\ Z = \frac{T}{U_c} \left(\frac{\sqrt{2}}{2} \cdot V_{bs.ref} - \frac{\sqrt{6}}{2} \cdot V_{as.ref} \right) \end{cases} \quad (11)$$

In the previous example for sector 1, $T_1 = -Z$ and $T_2 = X$. Extending this logic, one can easily calculate the sector number belonging to the related reference voltage vector. Application durations of the sector boundary vectors are tabulated as;

 TABLE III
 DURATIONS OF THE SECTOR BOUNDARY VECTORS

Sectors (S_i)	1	2	3	4	5	6
T_1	-Z	Y	X	Z	-Y	-X
T_2	X	Z	-Y	-X	-Z	Y

The third step is to compute the three necessary duty cycles as;

$$\begin{cases} T_{aon} = \frac{T_e - T_i - T_{i+1}}{2} \\ T_{bon} = T_{aon} + T \\ T_{con} = T_{bon} + T_{i+1} \end{cases} \quad (12)$$

V. DIRECT TORQUE CONTROL SCHEME USING SPACE VECTOR MODULATION (DTC-SVM)

The strategy of the *DTC-SVM* uses a switching *SVM* vector and imposed constant frequency. This DTC- fixed frequency does not use the controller hysteresis; it significantly relaxes the constraints of computing time. Furthermore, this methodology is based on an explicit calculation of the control to achieve the objective of torque, and the oscillations of the latter are considerably reduced [11].

This is a strategy for generating a stator reference voltage which should be applied to PMSM and it can be inserted into a block PWM inverter (see Fig. 6).

In *DTC-SVM*, the generation of command pulses (S_a, S_b, S_c) applied to control the inverter switches is usually based on the use of a predictive controller. The error of torque $\Delta C_e = (C_{eref}^* - \hat{C}_e)$, the reference amplitude stator flux ϕ_s^* delivered by predictive controller, It can receives information about the module and the position of estimated stator flux $\hat{\phi}_s$ and measured stator current vector, then the predictive controller determinate the stator voltage reference vector in polar coordinates $\bar{v}_{sref} = [V_{sref} \angle V_{sref}]$ for space vector modulator (SVM), which finally generates the pulses (S_a, S_b, S_c) to control the inverter [9].

From the vector diagram of Figure (5) and equation (1) one can obtain the following expression for the torque [11]:

$$\begin{cases} \hat{r}_s = -\frac{1}{l_d} \int_0^t (e_{ds} \hat{i}_{ds} + e_{qs} \hat{i}_{qs}) dt \\ \hat{\Omega}_r = \frac{1}{p} (k_p e + k_i \int_0^t e dt) \end{cases} \quad (17)$$

$$e = i_{ds} \hat{i}_{ds} - i_{qs} \hat{i}_{qs} - \frac{q_e}{l_d} e_{qs} \quad (18)$$

$$e_{ds} = i_{ds} - \hat{i}_{ds}; e_{qs} = i_{qs} - \hat{i}_{qs} \quad (19)$$

Where k_p and k_i are the proportional and integral constants respectively. The tracking performance of the speed estimation and the sensivity to noise are depending on proportional and integral coefficient gains. The integral gain k_i is chosen to be high for fast tracking of speed. While, a low proportional k_p gain is needed to attenuate high frequency signals denoted as noises [12].

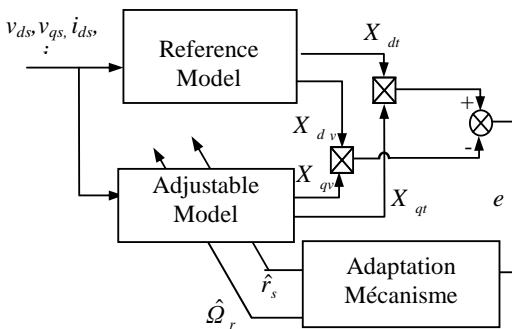

Fig. 7 Basic MRAS structure

V. Results of Simulation

Table (IV), summarizes the PMSM parameters used in this simulation [7].

TABLE IV PMSM PARAMETERS	
Pole pairs	3
Rated power KW (at 50 Hz)	1.5
Rated voltage (V)	220/380
Rated Flux (Wb)	0.30
Rated torque (Nm)	5
R_s (Ω)	1.4
$L_d ; L_q$ (H)	0.0066; 0.0058
Flux magnet (Wb)	0.15
J (Kg.m ²)	0.00176
f_r (N.m/(rad/s))	0.0038

We simulated the system drive for a reference speed of 100 (rd / s) load at startup, then from $t = 0.08$ (s), we assumed a variation of the stator resistance (see Fig. 5). At $t = 0.15$ (s), the PMSM is tracking load equal to 5 (Nm). The results are obtained using a PI speed controller.

Figure 8 illustrates the evolution of stator resistance, actual and estimated (delivered by the propose MRAS proposed for DTC/ DTC-SVM). The two quantities (estimated and actual resistances) are combined in practice, in steady state. As in Figure 9, it illustrates estimated speed (rad / s) issued by

MRAS, the speed response is achieved without dip and with a shorter recovery time which is almost similar with the actual speed motor.

Figure 10, shows the stator flux estimation using the MRAS. We notice that it is not affected by these changes. Electromagnetic torque follows his rate as shown in Figure 12.

Also, the flux and torque ripples are significantly suppressed due to the SVM modulation scheme as shown in Figure 11 and Figure 13

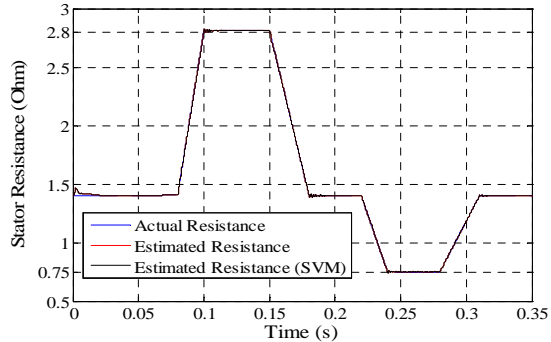

Fig. 8 Stator Resistance

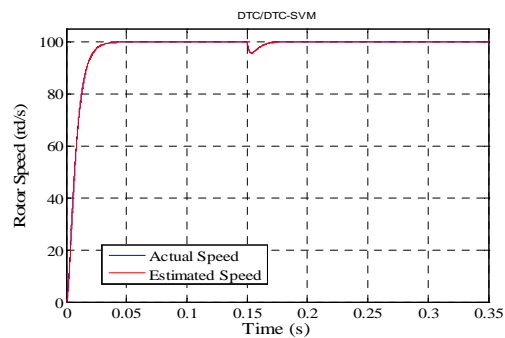

Fig. 9 Rotor speed

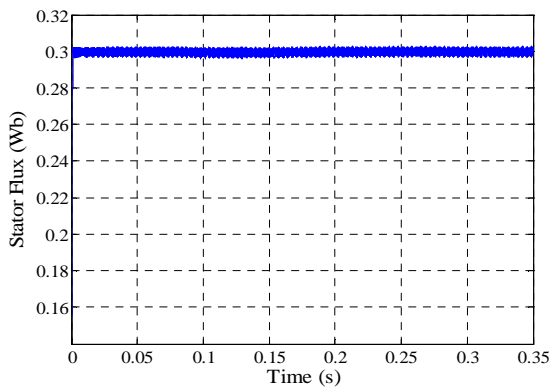

Fig. 10 Stator Flux

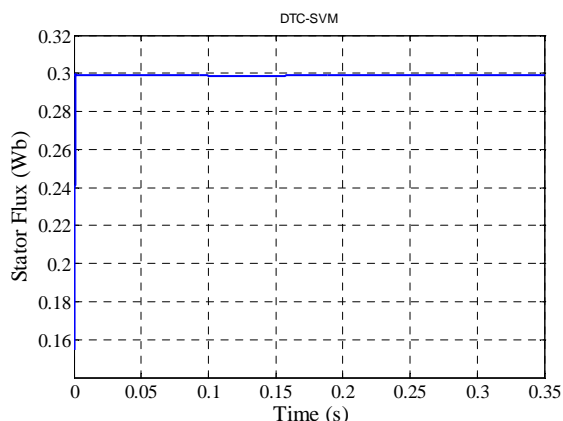

Fig. 11 Stator Flux

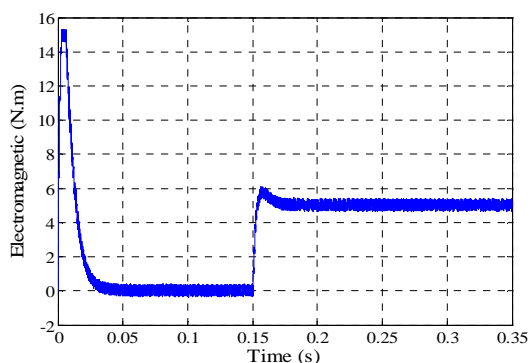

Fig. 12 Electromagnetic Torque

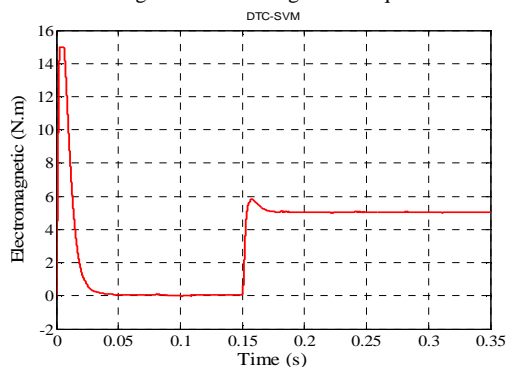

Fig. 13 Electromagnetic Torque

VI. CONCLUSIONS

In this paper, a robust MRAS for speed sensorless DTC-SVM scheme based on stator resistance estimator has been introduced. According to this control approach, the PWM inverter reference voltage vector is generated by a conventional PI predictor. The reference voltage vector is synthesized with the SVM technique as opposed to the switching table in the conventional DTC. The DTC-SVM scheme has lower harmonic current and consequently lower torque ripple than conventional hysteresis based DTC. Using of a model reference adaptive system for estimating the speed and stator resistance of a PMSM, compensate the effect of the variations of motor parameters and replace the position encoder. The obtained simulation results were satisfactory in

terms of estimation errors, robustness and global stability of the drive electrical system for different operating conditions.

REFERENCES

- [1] I. Takahashi, Y. Ohmori, "High-performance Direct Torque Control of an Induction Motor", *IEEE Transactions on Industry Applications*, Vol. 25, March/April 1989, pp. 257-264.
- [2] L. Zhong, M. F. Rahman, W.Y. Hu, K. W. Lim, M. A. Rahman, "A Direct Torque Controller for Permanent Magnet Synchronous Motor Drives.", *IEEE Transactions on Energy Conversion*, Vol. 14, September 1999, pp. 637-642.
- [3] F. Gilbert, S. Sayeef and M. F. Rahman, "SVM direct torque controlled interior permanent magnet synchronous motor drive using an extended Kalman Filter", *IEEE Conference on Power Electronics, Machines and Drives (4th IET on PEMD 2008)*, pp: 712 – 716, 2-4 April 2008.
- [4] J. Wang, H.h. Wang, X.I. Yuan and T.h. L, "Novel Direct Torque Control for Permanent Magnet Synchronous Motor Drive", *In proceeding of The 5th International Conference on Fuzzy Systems and Knowledge Discovery*, Volume 3, pp. 226 – 230, Jinan, China, Oct. 2008
- [5] B. Mokhtari, A. Ameer, L. Mokrani, B. Azoui and M.F. Benkhoris, "DTC Applied to Optimize Solar Panel Efficiency", *the 35th annual conference of the IEEE industrial electronics society iecon'09*, 11. 2009, porto, portugal.
- [6] M.C. Paicu, I. Boldea, G.-D. Andreescu F. Blaabjerg, "Very low speed performance of active flux based sensorless control: interior permanent magnet synchronous motor vector control versus direct torque and flux control", *IET Electr. Power Appl.*, 2009, Vol. 3, Iss. 6, pp. 551–561.
- [7] A. Ameer, B. Mokhtari, L. Mokrani, B. Azoui, N. Essounbouli, and A. Hamzaoui, "An Improved Sliding Mode Observer for Speed Sensorless Direct Torque Control of PMSM Drive with a Three-Level NPC Inverter Based Speed and Stator Resistance Estimator", *In Journal of Electrical Engineering*, Vol. 10, Edition-4, 2010, pp. 1-10.
- [8] M. Eskola, "Speed and Position Sensorless Control of Permanent Magnet Synchronous Motors in Matrix Converter and Voltage Source Converter Applications", Doctorat Thesis, Tampere University of Technology, Finland, 2006.
- [9] A. Bilal, "State Estimation Techniques for Speed Sensorless Field Oriented Control of Induction Motors", Master Thesis of the Middle East Technical University, Ankara, Turkey, 2003.
- [10] Y. Sam Kim, and S. Kyoong Kim, and Y. Ahn Kwon, "MRAS Based Sensorless Control of Permanent Magnet Synchronous Motor", *in Proceedings of SICE 2003 Annual Conference*, pp. 132-137, Korea, 2003.
- [11] D. Swierczynski and M.P. Kazmierkowski, "Direct Torque Control of Permanent Magnet Synchronous Motor (PMSM) Using Space Vector Modulation (DTC-SVM) - Simulation and Experimental Results", *In proceeding of the IECON-IEEE conference*, Nov. 2002.
- [12] S. Meziane, R. Toufouti and H. Benalla, "Speed Sensorless Direct Torque Control and Stator Resistance Estimator of Induction Motor Based MRAS Method", *International Journal of Applied Engineering Research (IJAER)*, Vol. 3, N° 6, 2008, pp. 733-747.