

# Solving a New Mixed-Model Assembly Line Sequencing Problem in a MTO Environment

N. Manavizadeh<sup>1</sup>, M. Hosseini<sup>2</sup>, M. Rabbani<sup>3</sup>

**Abstract**—In the last decades to supply the various and different demands of clients, a lot of manufacturers trend to use the mixed-model assembly line (MMAL) in their production lines, since this policy make possible to assemble various and different models of the equivalent goods on the same line with the MTO approach.

In this article, we determine the sequence of (MMAL) line, with applying the kitting approach and planning of rest time for general workers to reduce the wastages, increase the workers effectiveness and apply the sector of lean production approach.

This Multi-objective sequencing problem solved in small size with GAMS22.2 and PSO meta heuristic in 10 test problems and compare their results together and conclude that their results are very similar together, next we determine the important factors in computing the cost, which improving them cost reduced. Since this problem, is NP-hard in large size, we use the particle swarm optimization (PSO) meta-heuristic for solving it. In large size we define some test problems to survey it's performance and determine the important factors in calculating the cost, that by change or improved them production in minimum cost will be possible.

**Keywords**—Mixed-Model Assembly Line, particle swarm optimization, Multi-objective sequencing problem, MTO system, kit-to-assembly, rest time

## I. INTRODUCTION

MIXED-MODEL assembly lines make possible diverse models produce in the same time, and it's preventing to make a lot of numbers of production lines. In the real situation to solve a mixed-model assembly line two problems should be considered:

- a- Design and balance the assembly line (that concern in the line balancing problem)
- b- Determine the sequencing of models on the line (that concern model sequencing problem)

In this problem, we assume the line designing and balancing has occurred, and the stations are balanced that we cannot do any change in the balance of the line, and just consider the mixed-model sequencing problem [11], [6].

In the mixed-model sequencing problem two possible goals consider:

1. Leveling the load on each station on the line
2. Keeping a constant rate of usage of every part used by line [11].

Producers to obtain the costumer's demands and get the

high benefits, use different policies based on customers, products and their situations. In this problem, we use MTO approach in the JIT environment to ensure the diverse orders can secure with reduced cost, space and the minimum lead time; the time from give the order until deliver product to the customer;

One of the most elements in the MTO environment is flexibility in the MMAL that assists to delivering the products faster and make producing different models in the one line possible.

In the MTO system, since the products don't produce base on the forecasting from the past and they product from the real orders of customers, then the speed of the suppliers in manufacturing the orders is very important and effective. In the objective of model due date should decrease.

The JIT is a belief that should flow in the total factory to winning the applying JIT. In fact JIT should apply in four sections, which are product design, process design, human/organizational elements and manufacturing planning and control. Applying these parameters may be difference for every product or in each factory. The all the managers, engineers, employees and labors should believe and obeyed the JIT approach. In sum, we use the pull strategy and JIT in the production plan.

One of the most important elements to maximize the flexibility is feeding system. The feeding system consider in this paper is kit-to-assembly to fed the production line. We have two type of kit; one type is preparing the kit for end product to the customer, and the other type is packing the essential parts together in kit containers in the assembly line, which called "kit-to-assembly". In this way for every end-products some main components packed together in warehouse base on the determined scheduling of production plan in during every specific period of time, and then transferred to the main assembly line product.

A suitable feeding system can maximize the flexibility, and should be noticed the designing of kitting has a key role, since the poor designing has terrible effects on the performance of kitting, maybe increase the cost, time, idle time or even make the factory messier than using the kit[7].

Applying the lean production in the MMAL problem can maximizes the value added, with eliminating the unnecessary activities. The first step to performing the lean production is reducing the all type of wastes. Identified seven types of wasting that occurs in the factory: Over production, Waiting, Transportation, Over processing, Inventory, Defects, and Motion [7]. One of the ways to achieve of the lean production is using the kitting method, because by the help of kitting we

<sup>1</sup> PhD Candidate, Department of Industrial Engineering ,College of Engineering, University of Tehran, Tehran, Iran; (e-mail: nedamanavi@ut.ac.ir).

<sup>2</sup> MSc. Student, Department of Industrial Engineering, College of Engineering, University of Tehran, Tehran, Iran (e-mail: m.hosseini@ut.ac.ir).

<sup>3</sup> Professor of industrial Engineering, Department of Industrial Engineering, College of Engineering, University of Tehran, Tehran, Iran (e-mail: mrabbani@ut.ac.ir).

can reduce the stoppage of the line, idle time of the labor, transportation and defects.

Since packing the necessary materials in the kit, and transform it very faster than transforming individually to the original line; the time of the labor that wastes for preparing the material or waiting for arriving them, reduced.

Also, while the numbers of materials move together from the warehouse to the original line, the number of moving, the consumption of energy and the time of transporting reduced.

Use the kitting policy in the mixed-model assembly lines, has some advantages. It make possible to control the work in process (WIP) better, and decreased it. It declined the waste of assembly line, and bottlenecks, that make it possible product on the lean approach [7].

This method increases the quality, because approximately two times the pieces controlled, and if some decodes or faults were happened, the probability of its finding is more. Since, the materials and equipment inspect two times, one time in the warehouse while the packing them, and the other in the final assembly in the original line. So, furthermore we don't consider the special location for inspection, because that the labors observe two times materials and use them, the probability of exploring any effects increase.

One of the other aspects of kitting method is applying the 5S in MMAL problem. In the kitting approach the materials and equipment packed based on the standard method, which small sized or important parts situated in the suitable place in the kit package. Then the labors can pick and use equipment very simply and faster. It decreases the time of worker searching to find the essential pieces and additional movements, and increased execution of 5S.

Determining the kitting location in the factory is very important. We can design the kitting locations in two ways. Kitting with centralized picking store or kitting in decentralized areas.

The location of kitting maybe is depend on the situations of products, if the products consist of the high value materials or equipment it is possible, for increasing the safety of the basic materials considering the different or decentralized place it was better; or if the components of materials be very small or the transporting them from one workstation to another workstation was difficult, centralized location and kitting area was in the warehouse be better, because the risk of moving or missing reduced.

Kitting may be processed on one step or multi steps that is base on the selection of principles for putting in the kits or the process selection that should perform in the kitting stages.

The selection of principles and materials for positioned in the kits it can be according to the components situations. It is possible the manger's decision was that the high value materials, the small sized or the difficult transporting materials situated in the kits. Even the part of complex or criteria assembling execute in kitting.

The selection of principles and materials for positioned in the kits it can be according to the components situations. It is possible the manger's decision was that the high value

materials, the small sized or the difficult transporting materials situated in the kits. Even the part of complex or criteria assembling execute in kitting.

Designing the suitable configuration of the line assembly can have some affects on flexibility. The U-type assembly line is one of the types of line configurations. In the U-type assembly line the worker moving is easier than the straight-type assembly line.

U-line configuration make it possible to respond the fluctuations and changes of demand more effective and fast than straight-line formation, because U-lines act more flexible to adapt changes of customer demands, U-lines often are better than traditional straight lines[2]. Although u-line configurations maximize the flexibility of the production system, should have considered the cost of flexibility.

One of the other benefits of U-type assembly line is, the space in the middle of the U-assembly line, for using the better the free space and located the materials and equipments that maybe necessary for some stations these space is very good place, since the distance between the workstations and locations of materials reduced and avoiding wastes the space for allocating them near every workstations.

The other subject that cover in this article is using the relief worker to reduced the stoppage line. One of the most important targets in the MTO environment is being the nimble production system. To improve the benefits of a product system, we can use the relief-man (RM) as a soft facility. When the general workers aren't able to finish their assembly function during the transit of conveyor, the RM supports them. We assume RM as a multi-facility worker, that means the RM can move through the assembly line, and complete the every unfinished work in the all workstations. In this way the total conveyor stoppage time can be reduced [4], [5].

One of the most important factors in the MMAL with lean approach is exploiting from the operators in the maximum level. In this paper, to improve the quality in the assembly line and reducing the fatigue in the assembly line we suggest determine rest time for the original operators.

In the rest time, two scenarios suggest:

- 1- The relief-man replaces the original workers in the rest time, and reduces the speed of production in this specific time.
- 2- Divided the workers to two equal groups or shifts, and replace these shifts together in the rest time. In this method the production speed is constant.

It is based on the lines' conditions, maybe determining the rest time for the operators and reduce the production for limited time or even stop it, has the more benefits and profits for the system.

## II. LITERATURE REVIEW

Please submit your manuscript electronically for review as e-mail attachments. When you submit your initial full paper version, prepare it in two-column format, including figures and tables. Armin Scholl *et al.* found an intermixed sequence

of different models of a basic product, that assemble on an assembly line with consider fixed rate launching and closed stations an informed tabu search procedure with a pattern based vocabulary building strategy was developed to solve the NP-hard problem [8]. They attempt to minimize the work overload and respond the customer demands were their goals.

Jae Kyu Yoo *et al.* minimized the weighted sum of the line stoppage times and the idle time with presented a new type of the sequencing problem, and considered the help worker or relief man to increase the efficiency in the mixed-model assembly lines[4]. They established a hybrid method used by meta-heuristics like SA (simulated annealing) and TS (Tabu Search). They proved that the usage of relief man (RM) improve the flexibility to responding the changes of demands.

Giovanni Celano, *et al* to minimize the total conveyor stoppage time, they focused on management of human resource in manual mixed model assembly U-lines [5]. Several help policies between workers had been considered, to increase the assembly line performances. They accounted the speed of workers walking to conform to the real situation. The workers could use from the aided-worker, when they did not complete the assembly function. But they considered the help by frontal and downstream workers had. The presented algorithm was NP-hard, hence they use a proper genetic algorithm was developed for its optimization. The results proofed the effect of human factor management on the performance of assembly line.

Reference [9] to find the best sequence in a just-in-time (JIT) production system with considering the minimizing three objectives (total utility work cost, total production rate variation cost, and total setup cost) presented a new mathematical model. These three objectives based on their important of degree, weighted. They used early start schedule, and a minimum part set (MPS) production, which is a strategy widely accepted in the mixed-model assembly lines in their paper.

The authors compared its performance with the Lingo 6 software. The results displayed that their (MA) operations was very good especially in the case of large-sized problems.

In this paper the worker's moving time is ignored, and the stations are closed type.

Reference [3] shows a hybrid multi-objective algorithm based on Particle Swarm Optimization (PSO) and Tabu Search (TS) that minimize three objectives (total utility work cost, total production rate variation cost, and total setup cost) in the JIT environment, and they shows the presented algorithm is more efficient [3].

Fattahi et al. considered a mixed-integer programming model with a variable rate launching interval between products on the assembly line, to minimize the idle and utility time cost, with optimization sequencing and launching interval for each sequence, was presented [1]. This model used to solve the small-sized ones of these problems by the branch and bound method on lingo software to attain the optimal solutions. Since this problem was strongly NP-hard, a hybrid meta-heuristic algorithm based on the simulated annealing approach and a

heuristic approach was developed. To evaluate the performance of the proposed algorithm, three categories of testing problems were generated randomly: Small -, medium-, and large-size problems .Performance of the presented algorithm assessed with the results of experiments, proved that the proposed algorithm generated Solutions with good quality, comparable to the branch and bound method, very quickly.

They also solved the small-size problems with fixed launching interval by branch and bound method. The power point of this article is variable status of the launching interval between Products that studied at first in this paper. Although variable launching increase the complexity of the MMAL problem, but increased the flexibility of the assembly lines, that considering the effect of this assumption was discussed in this paper. Comparison of the results of fixed and variable launching interval cases show that, total costs of idle and utility work time for the variable launching interval case was less than in the fixed launching interval case .

In this paper the time of worker's movement did not calculate, and the regular workers could use from the aided-worker to complete the function of assembly.

### III. PROPOSED MODEL

#### A. Description of problem

We consider the mixed model assembly line with the multiple stations in the original assembly line that connected to each other with the conveyor belt. There are N products or models that we can product in the MMAL accordance the orders that we receive from the customers in the MTO system, the jobs arrived with a constant rate to the original line.

In the MTO system, we should decrease tardiness of the products and soon as possible the orders of customers prepare to increase customers` satisfy. We attempt to reduce the cost of tardiness for completing each model.

The stations have the limited time to finish their works that is base on the maximum processing time between all the models, thus we have the idle time in some stations but it helped the workers to complete their work in the relax situation, it caused the constant time for all the stations and reduced the line stoppage from the reason lake of time.

The model traveling time in the assembly line sets based on its processing time in every station and traveling time of products is less than the process time that workers have enough time to finish their work in the regular situation.

If any general workers don't finish their process, the relief worker helps them to complete the products as soon as possible, but RM cannot operate more than two workstations, simultaneously.

The stations are closed type, that the workers in the frontal or downstream cannot help to the worker that has uncompleted works and just the relief worker help him.

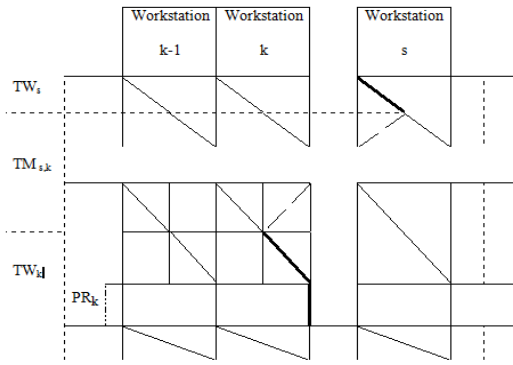

Fig. 1 line stoppage due to work delay of RM [4]

A constant feeding rate with using the kit to assemble approach considers, that reduced the line stoppage from the reason of shortage part. The workers that are working in the kitting area in each period of time or every day prepare some kits basis on the bill of orders that should complete in that period. We consider all the models need kits to prepare, and then the number of the kits is equal to the models that should prepare. But the materials can put in the kits and transport with the kits or carry individually. Both of types consider in the objective of model, and each type that has lower cost selected.

The necessary kits are prepared and located near the original line, thus we consider the time from arrived kits from kitting area to the original line unnoticed.

In the kitting subject, we consider the kitting location in the warehouse, and the kitting with the one step process. The number of stations in the kitting is constant.

Just the materials put in the kits and the equipment are placed near the original line. The manager of the factory to improve the workers' performance considers the rest time for number of limited workers. These workers are the constant workers in the original line that selected basis on their situation, duty or performance or maybe to encourage them. The manager with consulting with the engineers or the related person determines  $\beta$ .

The effect of rest time is more than the production in the low rate in especial times. In some production systems that the duty's workers are very heavy, complex or need much attention the rest times can be very effective to improve the workers' energy.

Basis on the occasional assembly line, the relief worker or the constant workers from kitting area can transform to the constant workers placement at the especial times of rest times. We determine the rest time schedule for the selected workers to use the rest and one program to placement changing with the aided worker or kitting workers. We assume they are multi-faculty worker that can replace with the original workers.

To minimizing the stoppage of line production and calculate it in the objective function, we consider the constant value for relief worker that paid him every month, but since he

is a multi faculty worker, for every stoppage of line he give extra money, which we prefer minimize it.

**B. Objectives**

We consider a multi-objectives sequencing problem to minimize four objectives in this model, but maybe the importance of them is difference, then we use  $\alpha$  to weight the objectives. In fact it is base on the manager view and the product situation.

**Assumptions:**

- 1-All the jobs are ready at time zero.
- 2-There is no unfinished work in the first station at the beginning of the production horizon.
- 3-The speed of conveyor is constant and shows with the  $V_c$  symbol. The finite speed to moving the workers in their stations considered with the  $V_g \geq V_c$  symbol.
- 4-The jobs passed the stations in the same sequence.
- 5-There is no buffer in the original line between stations.
- 6-To nearing the real situation we consider the speed of workers walking.
- 7-We consider the stations have different length, because base on the process that does in the every station it has variation.

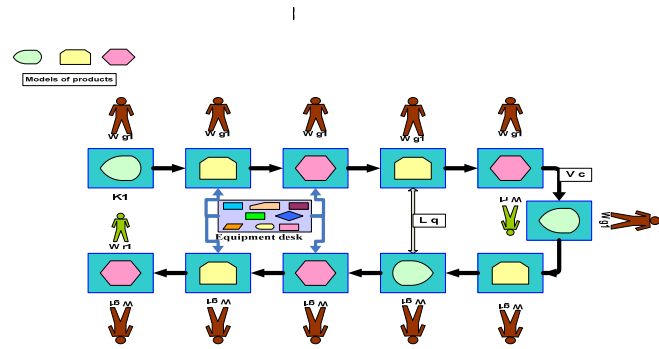

Fig. 2 U-type assembly line

**C. Formulation of problem**

**Parameters:**

**Stations:**

- $K$  Number of stations in the original line(=1,...k,s)
- $H$  Number of stations in the original line that need the kit (=1,...h)  $K, S \geq h$
- $M$  Position of assigning the job to stations (=1,...M)  $M = \sum_{i=1}^N D_i$

**Jobs:**

- $N$  Number of jobs or models that product in the original line(=1,...i, l)
- $D_i$  The numbers of demand for producing one unit of model i
- $Z_i$  The number of required parts for any model i that can put in the kit or transfer individually

**Workers:**

- $W_{g1}$  Number of general workers in the original line(=1,...g1)  $g1=N$
- $W_r$  Number of relief workers in the original line(=1,...r) for easily solve we assume one relief worker then  $r=1$

**Time:**

$TP_{i,k}$	Processing time of job i at station k
$TI_{(m,k)}$	Total idle time for general worker in the kth station
$TM_{s,k}$	Motion time of relief worker from station s to station k
$TW_s$	Working time of relief worker in station s
$TIR_{s,k}$	Idle time for relief worker between the finishing of work in the station s and starting the work in the station k
$TB_K$	the rest time for the gth labor in the Kth station
$Ta_i$	Tardiness in completing the model i
$du_i$	Due date for completing the model i

**Costs:**

$CD$	Cost of movement for an unit of distance
$CK$	Cost of preparing the kits in the kitting area
$CS$	Extra salary of relief worker that give for working in the stopped stations
$CI$	Cost of idle time
$CL$	Cost of tardiness for one unit of time

**Others:**

$LE_k$	duration time of passing station k
$DE_h$	Distance between the kitting area (kitting area and warehouse are the same location) to lth station
$A$	Interval time between jobs

**Modules:**

$A$	Module of Weighting factor
$B$	Module of the determining the rest time

**Variables:**

$X_{(i,m)}$	Binary variable, it is 1 if model i assigned to position m and model l assigned to position m+1
$Y_{(i)}$	Binary variable, it is 1 if for producing model i use the kit
$X'_k$	Binary variable, it is 1 if relief worker, worked in the kth station
$A_{i,k}$	Arrival time of job i at station k
$S_{i,k}$	Starting time for processing of job i at station k
$T_{i,s}$	Finishing time of job i at station s
$PR_k$	Time of stoppage line in workstation k for the reason that delay of the relief worker

**Model:**

$$MinZ_1 = \sum_{i=1}^N \left[ (y_i \times d_i \times \left( \sum_{h=1}^H (DE_h \times CD_{q,h} + CK) \right) + (1 - y_i) \times (z_i \times d_i \times CD_{q,h}) \right]$$

$$MinZ_2 = \sum_{h=1}^H (x'_k \times PR_k)$$

$$MinZ_3 = \sum_{k=1}^K TI_k$$

$$MinZ_4 = \sum_{i=1}^N (CL \times Ta_i)$$

We have the multi objectives problem.  $Z_1$  is related to the kitting cost or move the materials individually,  $Z_2$  related to the stoppage line that happened because of lateness of relief

workers in the  $k^{th}$  station [4],  $Z_3$  it is sum of the idle time of labors, original labor in the  $k^{th}$  station. part 4 it's about the lateness of preparing the orders and it's cost.

To solve easily and get the better results and nearest the real world, we use the weighted factors to solve these multi criteria.

$$MinZ = a_1 \times \sum_{i=1}^N \left[ y_i \times d_i \times \left( \sum_{h=1}^H (DE_h \times CD_{q,h} + CK) \right) + (1 - y_i) \times (z_i \times d_i \times CD_{q,h}) \right] + a_2 \times \left[ \sum_{h=1}^H (x'_k \times PR_k) \right] + a_3 \times \left[ \sum_{k=1}^K TI_k \right] + a_4 \times (CL \times Ta_i)$$

$\alpha_1$  it is related to the importance of the sections,  $\alpha_2$  considers the cost of stoppage line furthermore the factor of these section importance,  $\alpha_3$  considers the cost of idle time of the original labors like the  $\alpha_2$  consider these importance.

**Constraints:**

$$\sum_{l=1}^N \sum_{m=1}^N x_{l,i,m} = 1 \quad \forall m \tag{1}$$

This constraint is about that every position should be occupied with one product.

$$\sum_{l=1}^N \sum_{m=1}^M x_{l,i,m} = d_i \quad \forall i \tag{2}$$

This constraint is a guarantee to satisfy all the demands of every model.

$$\sum_{l=1}^N x_{l,i,m} = \sum_{l=1}^N x_{l,i,m+1} \quad \forall i, m = 1, m = 1, \dots, M - 1 \tag{3}$$

It is about the sequence constraint, which guaranteed model i go to the position m+1 after position m.

$$\sum_{l=1}^N x_{l,i,m} = \sum_{l=1}^N x_{l,i,l} \quad \forall i \tag{4}$$

This constraint concerns that the same sequence for all the products i.

$$A_{i,k} - \sum_{l=1}^N \sum_{m=1}^N x_{l,i,k} A_{lk} = a \quad \forall i, k \tag{5}$$

It is about the constant rate between the entrances of jobs to the assembly line, to smooth the workload [10].

$$A_{i,k} = A_{i,k-1} + LE_{k-1} \quad \forall i, k \tag{6}$$

$$S_{i,k} - A_{i,k} \geq 0 \quad \forall i, k \tag{7}$$

$$S_{i,k+1} - \sum_{l=1}^N \sum_{m=1}^M x_{l,i,m} \times T_{i,k} \geq 0 \quad \forall i, k \tag{8}$$

Eq (6-8) are about the constraints arrival the works to the stations and starting the works in the stations and feasible constraint for starting the works in the stations [10].

$$T_{i,k} - A_{i,k} \leq LE_k \quad \forall i, k \tag{9}$$

It is guarantee that the works could complete in the related station, the difference between finishing and arriving the product i in the station k is less or equal the length of station k [10].

$$TW_k \geq TW_s + TM_{s,k} \quad \forall k, s \tag{10}$$

It is about the starting time of relief worker in the kth station should be greater or equal the sum of working time in stations (workstation s is before station k) and motion time between the workstation s to k.

$$TI_k = \max(A_{i+1,k} - T_{i,k}, 0) \quad \forall k, i \tag{11}$$

$$TIR_{s,k} = \max(TW_k - TW_s - TM_{s,k}, 0) \quad \forall k, s \quad (12)$$

Eq (11), (12) are related to the idle time of the workers. Eq (11) is about the general workers in the original line, the maximum of zero or time between finishing the product i in station k and arriving the model l to station k, Eq (12) is about the idle time of relief worker between the completing products in the station s to station k [4].

$$TB_s + du \leq TB_k \leq \beta \times T_{N,K} \quad \forall k, s \quad (13)$$

It is about the constraint of rest time, which should be the proportional of TN,K.

To avoiding that all the original workers go to rest time at the one time, we consider this constraint. For the simple solve, we assume the du equal 15 minutes.

$$Ta_i = \max(0, T_{i,K} - du_i) \quad \forall i \quad (14)$$

It is about the tardiness in completing the model i, in the MTO system.

$$T_{i,s} = \min(A_{i,s} + LE_{i,s}, S_{i,s} + \sum_{l=1}^M \sum_{m=1}^N TS_{l,i,m} x_{l,i,m} + \sum_{l=1}^N \sum_{m=1}^N x_{l,i,m} \times TP_{l,s}) \quad \forall m, s \quad (15)$$

$$TW_s = \max(0, S_{i,s} + \sum_{l=1}^M \sum_{m=1}^N TS_{l,i,m} x_{l,i,m} + \sum_{l=1}^N \sum_{m=1}^N x_{l,i,m} \times TP_{l,s} - T_{i,s}) \quad \forall m, s \quad (16)$$

Eq (15, 16) are about the finished and the time of relief workers work in the s<sup>th</sup> stations. They calculate finishing time of model i and unfinished time of model i in station s [10].

$$X_{l,i,m} \& X'_k \& Y_i \in \{0,1\} \quad (17)$$

$$A_i, S_{i,s}, T_{i,s}, TW_s \geq 0 \quad \forall i, s \quad (18)$$

#### IV. SOLUTION METHODOLOGY

To solve the problem we use the GAMS and Matlab softwares. The GAMS is software that gives the exact results for the problems. And use the particle swarm optimization (PSO) with the Matlab software.

Kennedy and Eberhart [12], developed the PSO algorithm with considering the behavior of swarms in the nature, such as birds, fish, etc. In this Algorithm, a candidate solution is presented as a particle. PSO combines self-experiences with social experiences.

The PSO algorithm is population-based: a set of potential solutions evolves to approach a convenient solution (or set of solutions) for a problem. Being an optimization method, the aim is finding the global optimum of a real-valued function (fitness function) defined in a given space (search space).

All the particles move in the solution space and they attempt to search the best position. They used their memories, their neighbor memories and the history to arrive the best position.

The most problematic characteristic of PSO is its propensity to converge, prematurely, on early best solutions. Many strategies have been developed in attempts to overcome this but by far the most popular are inertia and constriction. The inertia term,  $x$ , was introduced thus Shi and Eberhart [13]:

$$v_{i+1} = \omega v_i + \varphi_1 \beta_1 (p_i - x_i) + \varphi_2 \beta_2 (p_g - x_i)$$

Later Eberhart and Shi [14] indicated that the optimal strategy is to initially set  $\omega$  to 0.9 and reduce it linearly to 0.4,

allowing initial exploration followed by acceleration toward an improved global optimum.

Constriction Clerc and Kennedy developed [15],  $\chi_s$  alleviates the requirement to clamp the velocity and is applied as follows:

$$v_{i+1} = x \{v_i + \varphi_1 \beta_1 (p_i - x_i) + \varphi_2 \beta_2 (p_g - x_i)\} \\ x = \frac{2}{|2 - \varphi - \sqrt{\varphi^2 - 4\varphi}|} \quad \text{where } \varphi = \varphi_1 + \varphi_2, \quad \varphi > 4$$

Our base PSO algorithm is A Novel Binary Particle Swarm Optimization [16]. This PSO method has a good performance in discrete value and in decision problems.

In this article, we use a new method to define the  $\varphi_1$  and  $\varphi_2$  different, because the problem values are small, we use  $\varphi_1 = 10$  and  $\varphi_2 = 15$ .

For investigating the performance of proposed PSO algorithm, a number of problems were tested in this section. This algorithm have been coded in the Matlab R2007b and executed on an Intel (R) Core (TM) i5 CPU, 2.4 GHz, and Windows seven using 4 GB of RAM.

#### I) For each particle:

##### Initialize particle

#### II) Do:

##### a) For each particle:

###### 1) Calculate fitness value

###### 2) If the fitness value is better than the best fitness value (pBest) in history

###### 3) Set current value as the new pBest

##### End

##### b) For each particle:

###### 1) Find in the particle neighborhood, the particle with the best fitness

###### 2) Calculate particle velocity according to the velocity equation (1)

###### 3) Apply the velocity constriction

###### 4) Update particle position according to the position equation (2)

###### 5) Apply the position constriction

##### End

#### While maximum iterations or minimum error criteria is not attained

Fig. 3 The pseudo code of PSO

#### A. Small-sized problems

In small size of problem, we solve it with GAMS 22.2 and MATLAB R2007b to sure from the accuracy of the proposed model. We consider 3 models with 4 workstations. Table1 considers the process time of the any model in every station, Workstation length and due date for every model.

TABLE I  
PROCESSING TIME AND WORKSTATION LENGTH

Workstation n	Model			Workstation length
	1	2	3	
1	12	22	20	12
2	11	15	21	14
3	18	10	21	12
4	19	15	15	15
Due date	65	70	82	

To solve the small size problem with the PSO approach, because of the few number of models and workstations, the problem convergence very soon.

We generate random data to survey the difference situations of the model.10 type of small size problem solved with GAMS and PSO algorithm, and results shows in table2.

The gap between the PSO and GAMS was calculated and the results compare together. To calculate gap, we compute the percent of diversity PSO and GAMS results and at last division it on the PSO results.

TABLE II  
TEST PROBLEMS IN SMALL SIZE

Small size	PSO results	Cpu time(second)	Gams results	Cpu time(second)	Gap
<b>Test problem1</b> Normal situation	Z= 1830.5	0.638954	Z=1830.5	2.474942	0
<b>Test problem2</b> Change process time	Z= 1830.5	1.040419	Z=1830.5	2.548752	0
<b>Test problem3</b> Change process time	Z= 3943.5	0.798124	Z=3943.5	2.501081	0
<b>Test problem4</b> Change MPS	Z= 8872.6	2.343321	Z=8872.6	6.608417	0
<b>Test problem5</b> Change MPS	Z= 1589.7	24.378059	Z=11590	8.407620	0.0025%
<b>Test problem6</b> Change c1,c2	Z=1830.5	0.782260	--	--	-
<b>Test problem7</b> Change distance from warehouse to the stations(to survey the importance of using kitting)	Z= 1830.5	0.688306	Z=1830.5	2.555815	0
<b>Test problem8</b> Change coefficient of cost	Z=78322	0.762708	Z=78322	2.472447	0
<b>Test problem9</b> Change coefficient of cost	Z= 1830.5	0.674772	Z=1830.5	2.569604	0
<b>Test problem10</b> Changing the number of necessary items to prepare the products	Z= 1830.5	0.686414	Z=1830.5	2.506129	0

We define 10 test problems to survey the performance of our model in different situations in both small and large size problems. Since this problem has multi factors to determine the important elements that have most effects on the total cost of the problem. Test problem 1 is defined as normal or base situation and the other situations compare with it.

We conclude from the table2 in small size that in all types of test problems, GAMS consume much time than the PSO, and PSO reach the solution sooner. Almost their results have little gap that means their results are very near together.

In all the test problems, changing in total demand or MPS and coefficient of cost has the most effects on the total cost of the problem. We can conclude that the other situations haven't considerable effect on the cost. Hence to get the minimum cost in the production we should have change in the coefficient of cost, because if we reduce them by some methods like using better transportation vehicles or new approach to produce the kits or reduce the number of moving or distances, reducing the tardiness or the time of unfinished products we can minimize the total cost of production. It is obvious that in small number of MPS, total cost is fewer, but the objective of MMAL is provided the diverse demand of customers, then we should use approaches that

reduce the tardiness of products. The graphs of global best cost for all the test problems are shown in the appendix.

#### B. Large-sized problems

For solving the medium and large size of problem, we use the Meta heuristic algorithm (particle swarm optimization algorithm) in the MATLAB R2007b.

We consider 10 workstations with 5 models, and the process time generates randomly between 10 to 22 minutes, with 10 customers that can order the products randomly and varied in every run of problems.

We run 10 type of large size problem with random data, and results there are in table III. In the large size problem results that reach from table3, we conclude furthermore changing the MPS and cost of coefficients, process time has the strong effects on the cost of production.

Since the number of models and stations increase from small sized, changing in the process time has big effect on the cost. In large size problem, reducing the time of process production is very important, by using the improvement methods reducing the each process time is possible and then we can reduce the cost of production. The graphs of global best cost for all the test problems are shown in the appendix.

TABLE III  
TEST PROBLEMS IN LARGE SIZE

Large size		PSO results	Cpu time (second)
<b>Test problem1</b>	Normal situation	Z=23610.6	2.021136
<b>Test problem2</b>	Change process time	Z=101313.6	2.120699
<b>Test problem3</b>	Change process time	Z=15848.5	2.065688
<b>Test problem4</b>	Change MPS	Z=69883.5	4.621250
<b>Test problem5</b>	Change MPS	Z=47984.7	3.600461
<b>Test problem6</b>	Change c1,c2	Z=25476.4	2.092878
<b>Test problem7</b>	Change distance from warehouse to the stations(to survey the importance of using kitting)	Z=23521.3	2.260024
<b>Test problem8</b>	Change coefficient of cost	Z=61112	2.084018
<b>Test problem9</b>	Change coefficient of cost	Z=59853	2.191763
<b>Test problem10</b>	Changing the number of necessary items to prepare the products	Z=23473.3	2.207509

#### V. CONCLUSION

In the mixed model assembly line (MMAL) problem, determining the sequence of the arriving the jobs in the production line is very important and effective on the cost of production. The suitable sequence can reduce the tardiness of delivering the products to the customers, or the idle time of the workers and the stoppages of the line.

In small size of the problem, we solve it with the GAMS software and the PSO algorithm in 10 test problems and compare the results together to check the accuracy of the model. In small size MPS and cost of coefficients have the strong impress on the total cost of production that with change them basically, the cost of production reduced.

Since this problem is Np-hard to solve it in the large sized, we should use the meta-heuristic approach. The particle swarm optimization is one of the meta-heuristic methods that is copied from the nature environment. PSO method is one of the swarm intelligence algorithms that use the experiences' of particles in every iteration and their experiences in the past. We define 10 test problems in different situations and compare the obtained results together. In large size MPS, cost of coefficients and process time have the most importance in the total cost of production. Changing in their value has strong effects on the cost. Then with improving in their values cost of production will increase.

To improve this problem we can consider some other objectives, to near the real situation. This problem can solve with the other meta-heuristic methods, like the GA, SA... or the hybrid of them.



APPENDIX

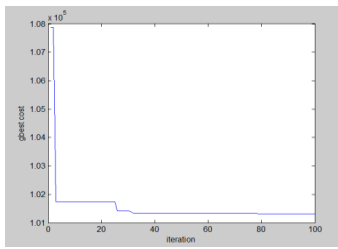

Fig. 1 The graph of test problem1 in small size

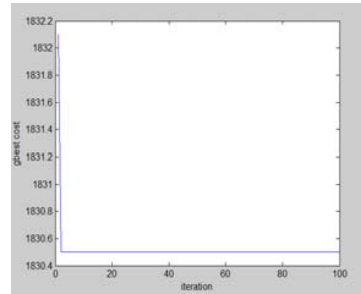

Fig. 4 The graph of test problem3 in large size

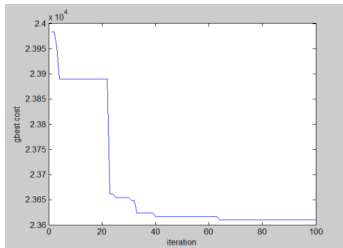

Fig. 2 The graph of test problem1 in large size

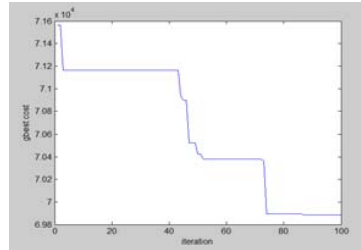

Fig. 5 The graph of test problem4

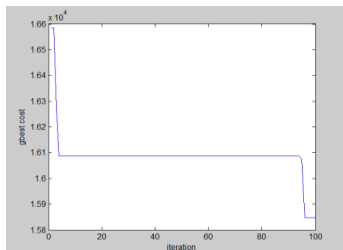

Fig. 3 The graph of test problem2 in large size

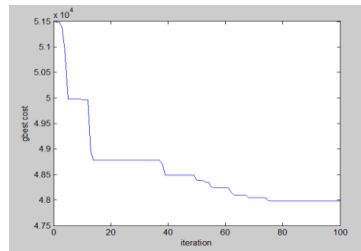

Fig. 6 The graph of test problem5

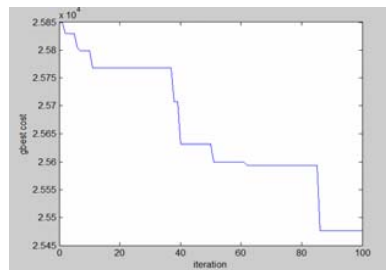

Fig. 7 The graph of test problem6

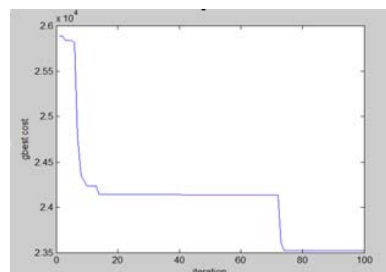

Fig. 8 The graph of test problem7

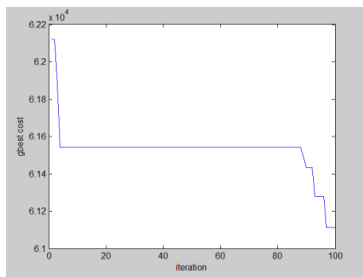

Fig. 9 The graph of test problem8

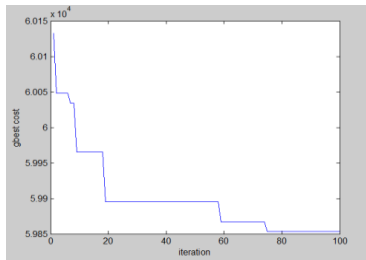

Fig. 10 The graph of test problem9

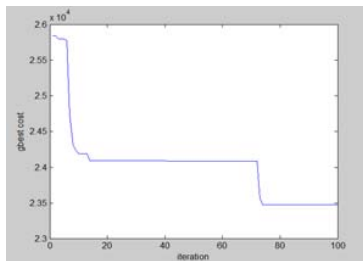

Fig. 11 The graph of test problem10

## REFERENCES

- [1] P. Fattahi , M. Salehi," Sequencing the mixed-model assembly line to minimize the total utility and idle costs with variable launching interval ". *Int J Adv Manuf Technol*, vol.12, 2009.
- [2] I. Sabuncuoglu, E.Erel, ArdaAlp, "Ant colony optimization for the single model U-type assembly line balancing problem ".*Int J.Production Economics*, vol. 14, 2008.
- [3] S.M. Mirghorbani, M. Rabbani, R. Tavakkoli-Moghaddam, and A. Rahimi-Vahed,"A Multi-Objective Particle Swarm for a Mixed-Model Assembly Line Sequencing", *Engineering Optimization*, vol.11, 2007, pp. 997-1012.
- [4] J. Kyu Yoo, Y.Shimizu and Rei Hino". A sequencing problem for mixed-model assembly line with the aid of relief-ma" *JSME International Journal*, vol. 6, 2005.
- [5] G. Celano, A.Costa, S. Ficheraa, G. Perrone, "Human factor policy testing in the sequencing of manual mixed model assembly lines ". *Computers & Operations Research*, vol. 31 2004, pp. 39–59.
- [6] S.M.J .Mirzapour Al-e-Hashem and M.B . Aryanezhad, "An Efficient Method to Solve a Mixed-model Assembly Line Sequencing Problem Considering a Sub-line ".*World Applied Sciences Journal*, vol. 6, 2009, pp. 168-181.
- [7] O. carlsson, B. Hensvold, "kitting in a high verification assembly line-a case study at caterpillar BCP-E ".2007 :95.
- [8] A. Scholl, R. Klein, W. Domschke," Pattern based vocabulary building for effectively sequencing mixed-model assembly lines ".*Journal of Heuristics*, vol. 4, 1998, pp. 359–381.
- [9] R.Tavakkoli-moghaddam, A.R.Rahimi-Vahed, "multi-criteria sequencing problem for a mixed -model assembly line in a jit production system ". *Applied Mathematics and Computation*, vol. 181, 2006, pp. 1471–1481.
- [10] S. Kim, B. Jeong, "Product sequencing problem in Mixed-Model Assembly Line to minimize unfinished works ".*Computers & Industrial Engineering*, vol. 53, 2007, pp. 206–214.
- [11] J.Miltenburg, G .Sinnamon, "Scheduling mixed model multi-level just-in-time production systems." *International Journal of Production Research*, vol. 27, 1989, pp.1487–1509.
- [12] J. Kennedy, RC. Eberhart, "Particle swarm optimization", in *conf. Rec.1995 IEEE international conference on neural networks, Piscataway, NJ*, pp. 1942–1948.
- [13] Y. Shi, RC .Eberhart," A modified particle swarm optimizer", in *conf. Rec. 1998 IEEE international conference on evolutionary computation. IEEE Press, Piscataway, NJ*, pp. 69–73.
- [14] RC. Eberhart, Y. Shi, "Comparing inertia weights and constriction factors in particle swarm optimization". In *2000 IEEE congress evolutionary computation, San Diego, CA*, pp. 84–88.
- [15] M .Clerc, J. Kennedy," The particle swarm: explosion, stability and convergence in a multi-dimensional complex space" .in *2002 IEEE Trans Evol Comput*, vol. 6, pp. 58–73.
- [16] M. Ahmadih Khanesar, (July 2009). "A Novel Binary Particle Swarm Optimization", in *2009 conf. 15th Mediterranean conference on control & automation*.