

Smart Power Scheduling to Reduce Peak Demand and Cost of Energy in Smart Grid

Hemant I. Joshi, Vivek J. Pandya

Abstract—This paper discusses the simulation and experimental work of small Smart Grid containing ten consumers. Smart Grid is characterized by a two-way flow of real-time information and energy. RTP (Real Time Pricing) based tariff is implemented in this work to reduce peak demand, PAR (peak to average ratio) and cost of energy consumed. In the experimental work described here, working of Smart Plug, HEC (Home Energy Controller), HAN (Home Area Network) and communication link between consumers and utility server are explained. Algorithms for Smart Plug, HEC, and utility server are presented and explained in this work. After receiving the Real Time Price for different time slots of the day, HEC interacts automatically by running an algorithm which is based on Linear Programming Problem (LPP) method to find the optimal energy consumption schedule. Algorithm made for utility server can handle more than one off-peak time period during the day. Simulation and experimental work are carried out for different cases. At the end of this work, comparison between simulation results and experimental results are presented to show the effectiveness of the minimization method adopted.

Keywords—Smart Grid, Real Time Pricing, Peak to Average Ratio, Home Area Network, Home Energy Controller, Smart Plug, Utility Server, Linear Programming Problem.

I. INTRODUCTION

PRESENTLY the majority of the countries use centralized power generation and hierarchical structure of power grid. A vast majority of electrical power is generated by fossil fuel and nuclear fuel in the world. Due to a bad effect on the environment and limited resources of it, non-conventional energy sources are required to integrate with conventional power grids. Gradually, the share of the non-conventional power is required to increase in the grid. Apart from this, the majority of countries use flat rate tariff that does not give incentives to customers to use the power during the off-peak period. To integrate the non-conventional energy sources efficiently with the conventional power grid and implement different types of DR programs, the conventional power grid must be converted into Smart Grid [1], [2]. Such type of evolution of the conventional power grid to Smart Grid is shown in Fig. 1.

A Smart Grid provides path to both electrical power and information for minimization of environmental impact and energy cost to improve reliability and efficiency of the grid

H. I. Joshi is with the School of Technology, R. K. University, Rajkot, India (corresponding author; Phone: +91-9998579554; e-mail: hemant_742000@yahoo.co.in).

V. J. Pandya is with the School of Technology, Pandit Deendayal Petroleum University, Gandhinagar, India. (e-mail: vivek.pandya@sot.pdpu.ac.in)

[3]. While generating, transmitting and distributing the electrical power, the major challenge for the utility is to match supply and demand [4]. This challenge can be overcome by shifting the operations of the schedulable appliances. There are various methods suggested in the different literature about shifting the operation of schedulable appliances [5], [6]. One out them is Direct Load Control (DLC) [7]. In this method, the utility is empowered to control the appliances whenever required. This method provides less comfort to consumers. Incentives must be provided to the consumers for utilization of energy during the off-peak period.

Real Time Pricing (RTP) method is better than the former due to some of its prominent features [8]. In this method, the utility sends RTP rates and useful signals regularly to the smart meters of all the consumers. HEC (Home Energy Controller) can be used to calculate optimized time slots for the schedulable appliances to reduce a cost of energy, peak demand and Peak to Average Ratio (PAR) [9], [10]. To achieve this important goal of Smart Grid, two-way communication between customers and utility is required. Smart Grid consists of various types of sensors, smart meters, Home Energy Controllers [11]. Two-way communication can be provided between the smart meter and service provider using GSM (Global System for Mobile) network or WiMAX (Worldwide Interoperability for Microwave Access) [12], [13]. Various data such as real power, apparent power, voltage, current, and power factor are required to exchange between the service provider and consumer [14].

The domestic appliances can be divided into two categories. One is schedulable and another is non-schedulable [15], [16]. Delayed operation of a schedulable load doesn't make a difference for customers. Appliances like PHEV (Plugged in Hybrid Electric Vehicle), washing machine, water pump and dishwasher can be considered as schedulable appliances. Non-schedulable appliances must get power when switched on.

In RTP based tariffs, to calculate optimized time slots for the schedulable appliances, HEC is used to reduce peak demand of the grid [9], [10], [17]. In Home Area Network (HAN), HEC is connected with schedulable load through ZigBee to send or receive signals. Such a network is shown in Fig. 2.

If energy usage during the entire day remains same, reduction in the peak load results in the reduction in PAR. If the entire schedulable load is shifted towards off-peak period, peak load condition arises during that time interval. This condition is called the rebound peak condition [7]. While minimizing the energy cost; PAR is not allowed to rise to avoid rebound peak condition.

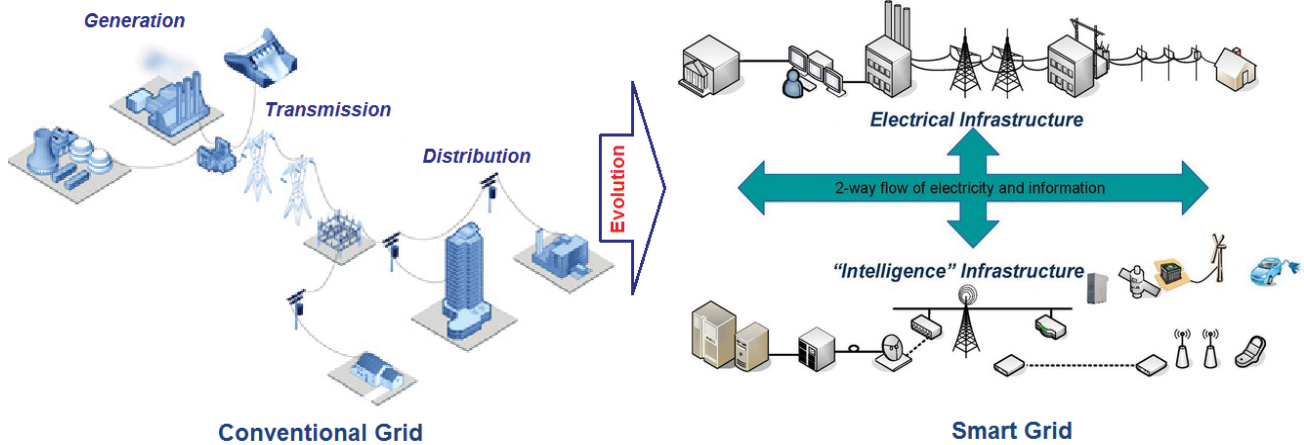

Fig. 1 Evolution of smart grid from conventional power grid

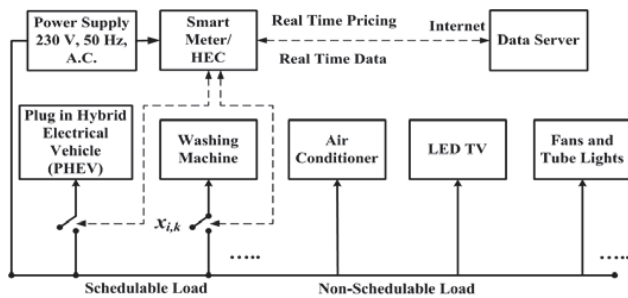

Fig. 2 Home Area Network for user i

In this work, the group of ten customers is considered for experimental setup and simulation and experimental results are presented and compared for different cases.

The remaining paper is organized as follows. Section II introduces residential power scheduling model, Section III presents simulation results, Section IV presents hardware development, Section V presents experimental setup and results and Section VI presents conclusions and potential future directions.

II. RESIDENTIAL POWER SCHEDULING MODEL

Let \mathbf{I} denote the set of users where the number of users are $I \triangleq |\mathbf{I}|$. For each customer, $i \in \mathbf{I}$, let l_i^t denote the total load at hour $t \in T \triangleq \{1, 2, \dots, \tau\}$, where the value of τ is taken as 24. The cost of unit changes after every hour. The daily load of user i is denoted by $l_i \triangleq \{l_{i,1}, l_{i,2}, \dots, l_{i,\tau}\}$ [8].

Based on the above definitions, the total load of all users at each hour of the day $t \in T$ can be given by

$$L_t \triangleq \sum_{i \in \mathbf{I}} l_i^t \quad (1)$$

Based on the above calculations, Peak to Average Ratio (PAR) for all the users can be calculated by following steps

$$L_{\text{peak}} = \max_{t \in T} L_t \quad (2)$$

and

$$L_{\text{average}} = \frac{1}{T} \sum_{t \in T} L_t \quad (3)$$

So PAR can be calculated by

$$\text{PAR} = \frac{L_{\text{peak}}}{L_{\text{average}}} = \frac{T \cdot \max_{t \in T} L_t}{\sum_{t \in T} L_t} \quad (4)$$

A. Power Scheduling Strategy

As discussed in the earlier section, non-schedulable appliances must be turned on whenever it is required, while the operation of schedulable appliances is controlled by HEC. Schedulable appliances are 'turned on', on the condition of RTP signal (or in other sense peak or off-peak condition). Let K_i (for $i \in \mathbf{I}$) denote the set of schedulable appliances (such as PHEV, washing machine etc.) as presented in Fig. 2. Schedulable appliances receive power through Smart Plugs. Smart Plugs only allow power to schedulable appliances if permission is granted from HEC. Utility may deny permission to particular HEC if total demand of the grid exceeds the permissible limit. For the experimental setup used here, this limit is 22 kW. The power ratings of PHEV and Washing machine are taken as 3 kW and 1 kW respectively [18].

B. Energy Cost

Here, energy cost is a variable quantity. C_t represents energy cost in terms of Rs./unit at t^{th} hour where $t \in T$. Considering the energy cost C_t , the total cost of energy consumed by schedulable appliances can be given by

$$C_t \left(\sum_{i \in \mathbf{I}} \sum_{k \in K_i} x_{i,k}^t \right), \forall i \in \mathbf{I} \quad (5)$$

C. Minimization of PAR and Energy Cost

The minimization of PAR [19] can be given by

$$\underset{x_i \in X_i, \forall i \in \mathbf{I}}{\text{minimize}} \max_{t \in T} \left(\sum_{i \in \mathbf{I}} \sum_{k \in K_i} x_{i,k}^t \right) \quad (6)$$

The cost of energy consumption can be minimized by scheduling the operation of schedulable appliances towards lower energy cost intervals (or off-peak period) for all the users. So cost minimization problem can be given by (7):

$$\underset{x_i \in X_i}{\text{minimize}} \sum_{t=1}^T C_t \left(\sum_{i \in \mathbf{I}} \sum_{k \in K_i} x_{i,k}^t \right) \quad (7)$$

In this work, the goal is to minimize both PAR and energy cost. Equation (7) can be solved by linear programming calculations [19], [20]. Utility sends signals regarding peak value on the grid and according to it each HEC designs schedule x_i^t . Utility checks for peak value to avoid any rebound peak. Whenever request from any schedulable appliances $k \in K_i$ is received, HEC (of user i) sends signals to utility. HEC calculates optimized time schedule as per (7). Utility checks for peak load that may occur by allowing this schedulable appliance $k \in K_i$. If there is no possibility of occurrence of peak load by allowing any schedulable appliance k , a “switched on” permission will be granted to HEC of user i . If new request from any user for such schedulable appliance $k \in K_i$ is received after achieving peak load, that appliance has to wait until the new time slot t . After allowing permission to a new schedulable appliance, HEC sends the total load x_i^t (in kW) of user i to utility.

III. SIMULATION RESULTS

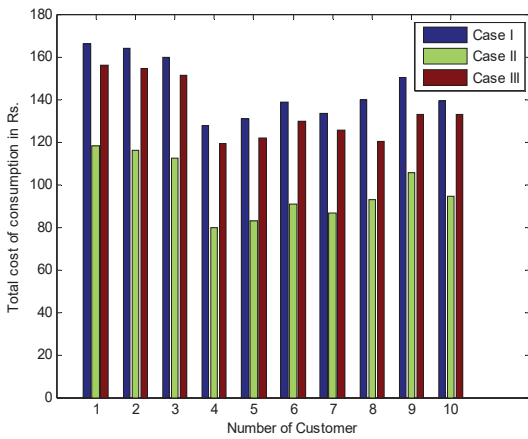

(a) Comparison of daily energy cost of each customer for all the cases

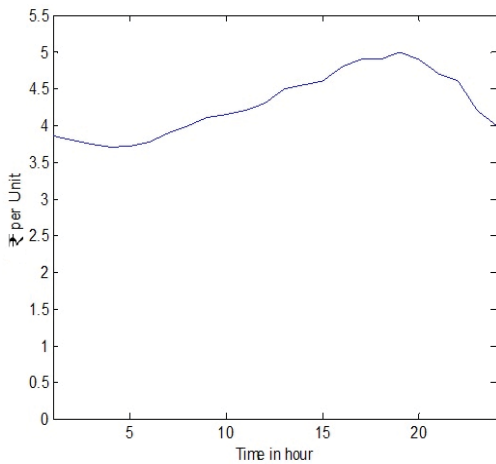

(b) RTP signal sent by utility

Fig. 3 Comparison of daily energy cost of each customer for all the cases and RTP signal sent by utility

The simulation for the minimization of PAR and energy cost is done using MATLAB. The simulation is carried out considering the three different cases. RTP based tariff is used in all the cases. Any number of customers and any number of schedulable appliances for each customer can be considered for this work. However, for simplicity only 10 customers and two schedulable appliances per customer have been considered for this simulation. Simulation results for different cases are presented in [19]. Comparison of total cost of consumption for three different cases is presented in Fig. 3 (a).

In first case, value of PAR is 3.21 and energy cost of the day is also higher as compared with second and third case. In this case any PAR and energy cost minimization techniques are not used. In second case, operation of all the schedulable appliances are shifted to low priced time slots. Considerable saving in energy cost is observed in second case but PAR in that case is 2.48 and rebound peak occurs in that case. In third case, operation of schedulable appliances is shifted to low priced time slots but after reaching the permissible value of peak load (22 kW) during off-peak period, this process of shifting is stopped. Third case is acceptable as the PAR in this case is 1.62, which is the lowest among all cases [19]. The RTP signal sent by utility (and used for simulation) is shown in Fig. 3 (b).

IV. HARDWARE DEVELOPMENT

A. Home Energy Controller

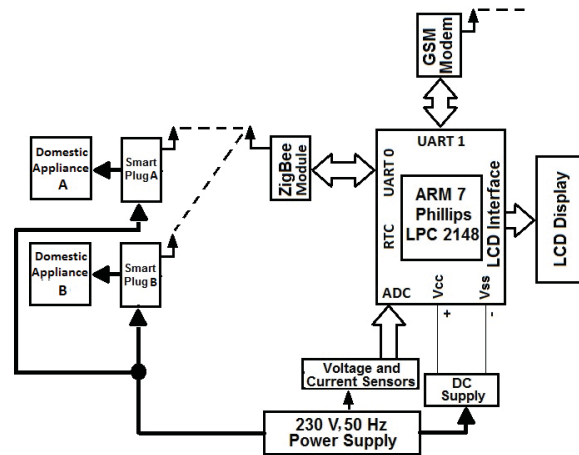

Fig. 4 Architecture showing HEC, Smart Meter and HAN

The architecture of HEC cum smart meter and HAN is presented in Fig. 4. In such system, communication links are established between users and utility servers through GSM network [9], [10]. For data collection, RS232, RS485 serial ports or ZigBee can be used. In this work ARM Core, Phillips LPC 2148, 32 bit, 64 pin processor is used. The smart meter unit and HEC are made in a single hardware. Home Area Network is made using ZigBee. This is low power, low cost and lower data rate (250 kb/s) network. In future, the domestic appliances based on the IPv 6 will be available in the market that can directly communicate with HEC (or even with utility). However presently such appliances are not available in the

market so in this work, the smart plug is made that allows power to domestic appliances according to the signals sent by HEC.

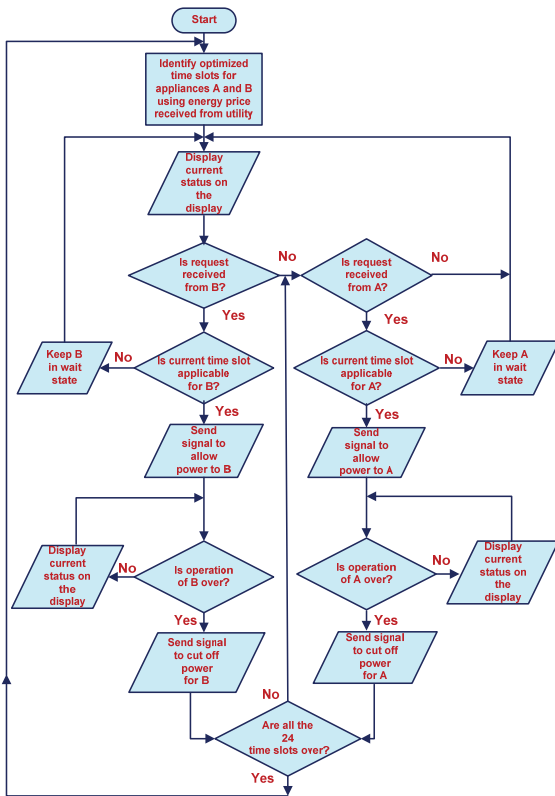
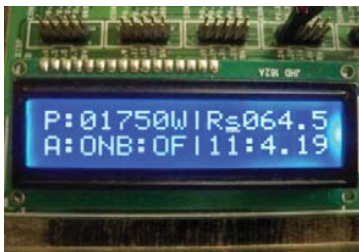

Fig. 5 Flow chart for the operation of HEC



(a) Actual view of Home Energy Controller



(b) LCD display of HEC showing different information

Fig. 6 Actual view and display of HEC

The flow chart for the operation of HEC is shown in Fig. 5. The program for HEC is made to identify the successive minimum priced time slots for schedulable loads A and B. Fig. 6 (a) shows the actual view of HEC. The LCD display shows different types of information during the working of HEC. This is shown in Fig. 6 (b). In the first line, current power consumption, P in Watts and total cost of energy consumed (in Rs., till the time of a day) is displayed. In the second line, current status of schedulable appliances A and B are shown. In Fig. 6 (b), “A: ON” and “B: OF” indicates that currently device A is turned on and B is turned off by HEC.

B. Role of Smart Plug

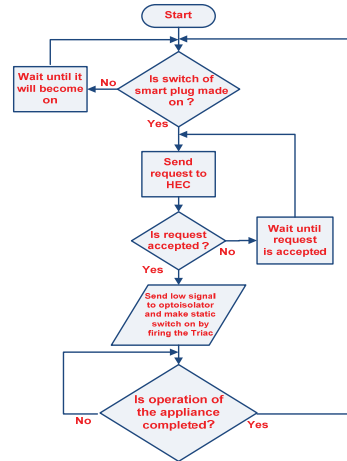

(a) Flowchart for the operation of Smart Plug

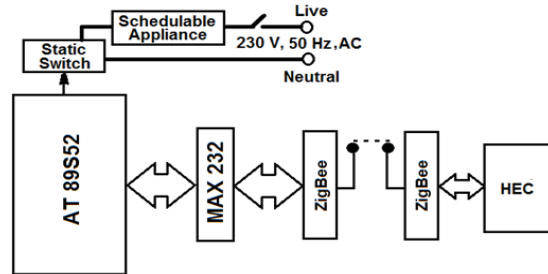

(b) Functional block diagram showing communication between Smart Plug and HEC



(c) Actual view of smart plug

Fig. 7 Flowchart, functional block diagram and actual view of Smart Plug

The Smart Plug works according to the signals received from HEC. It allows power to domestic appliances, according to the signals sent by HEC. In Fig. 7, operation of Smart Plug is explained.

C. Role of Utility Server in Reduction of PAR

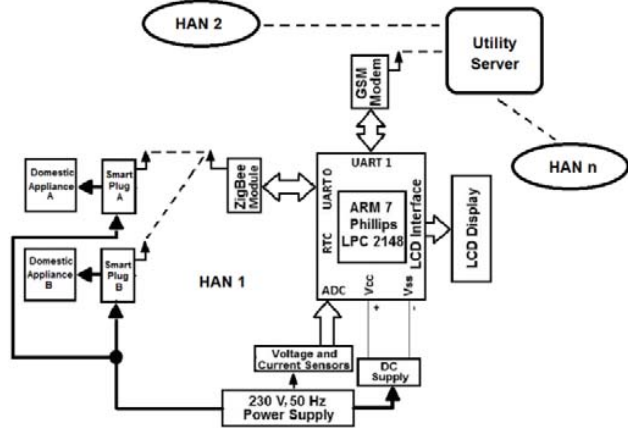

Fig. 8 Infrastructure of small Smart grid

Fig. 8 shows the infrastructure of the small grid which presents the experimental setup of this work. In this grid, RTP based tariff is implemented to achieve the reduction in peak demand and PAR. To implement this tariff, all customers must have one HEC and required smart plugs (as many as the numbers of schedulable appliances). In the experimental setup presented here, only one HEC and two smart plugs for first customer are used and to represent the operation of other nine customers, programmable load is used that works as good as the group of remaining nine HECs of remaining nine customers. The algorithm for utility server to minimize peak load, PAR and cost of the energy consumed of the grid is explained in Fig. 9. The experimental setup using such strategy is shown in Fig. 10.

Everyday utility server sends the RTP at 12:00 a.m. to all the customers. HECs of all the customers receive these data and by running an algorithm (as explained in 4.1) it finds out the successive low priced time slots for all schedulable appliances.

D. Working of Utility Server

During the off-peak period if any customer switches on the smart plug to allow power to its schedulable appliances, the request will be sent to first HEC and then to utility server. All the requests received are registered and priority is given to all the registered customers. In this setup, the unique protocol is used to send and receive the commands. If customer 1 wants to give power to its schedulable appliances B1, (all the B type appliances are PHEV and having consumption of 3 kW) HEC1 of customer 1 sends commands \$B1# to the server (any kind of code can be used). At that time all the registered customers send request \$Bn# (n=1, 2, n) to server and server registers all the request and priority is given to them on first come first serve basis. After considering the allowable

capacity of the power for that grid, the server sends signals to customers to allow the power on priority basis.

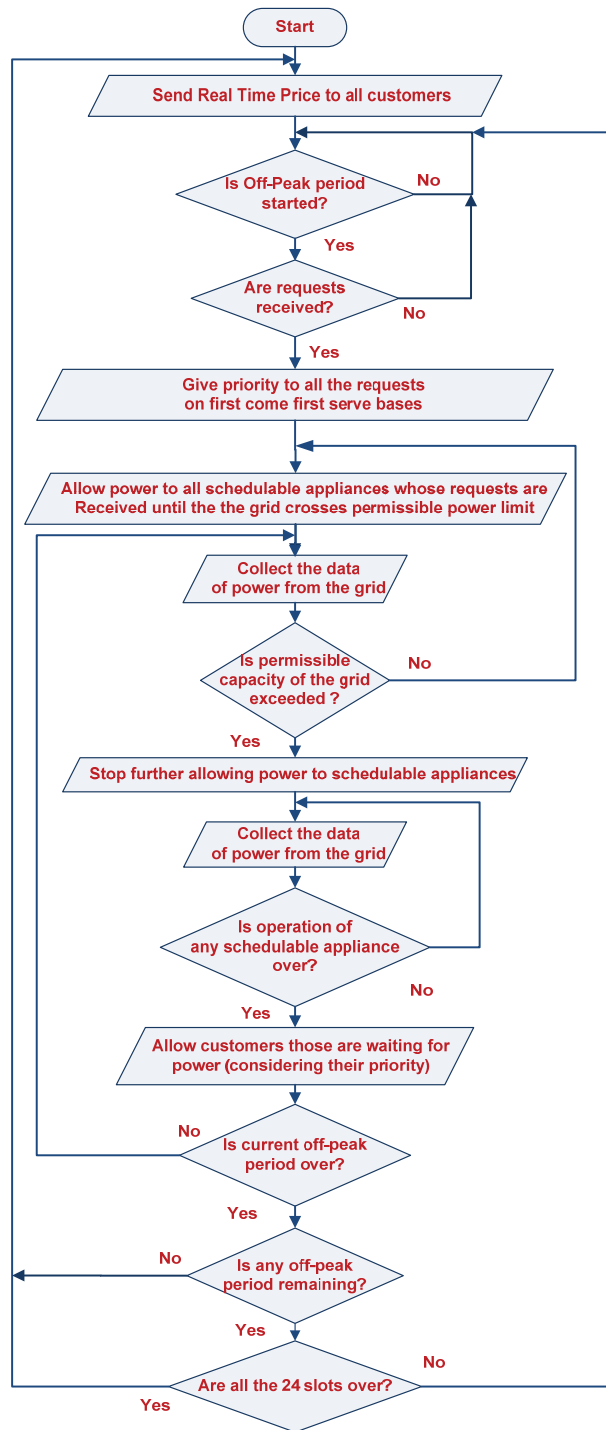

Fig. 9 Flow chart for the operation of utility server

If the request of B type of appliances of customer 'n' is fulfilled, the server sends command *Bn# and immediately the B type appliance of customer 'n' will receive the power. This process takes only a few seconds. Whole process is explained

in Fig. 9. To avoid the rebound peak condition during the off-peak period, the server continuously monitors the current demand of the grid. When grid capacity reaches near allowable capacity, permission is denied to remaining appliances.

These remaining appliances have to wait until the completion of the operation of schedulable appliances connected to the grid. After completion of the operation of those schedulable appliances, the server again sends command and allows power to appliances those are in waiting (considering their priorities).

V. EXPERIMENTAL SETUP

In this setup, as explained in IV A, only one Home Area Network of customer-1 is made and for remaining customers programmable load is used that responds to the server as good as real Home Area Networks. The layout and actual view of it is presented in Fig. 10 (a).

Lamps having rating of 75 W and 25 W are used instead of PHEV and washing machine respectively to save energy during experiment. Time slot having one minute instead of one hour is used to save overall time during the experiment.

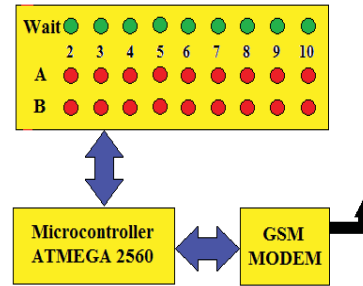

(a) Layout of programmable load

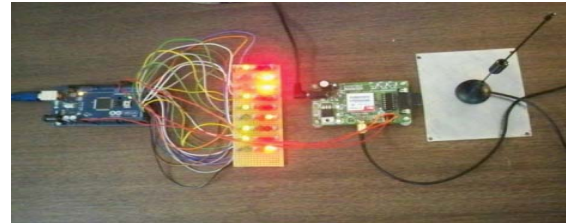

(b) Actual view of programmable load

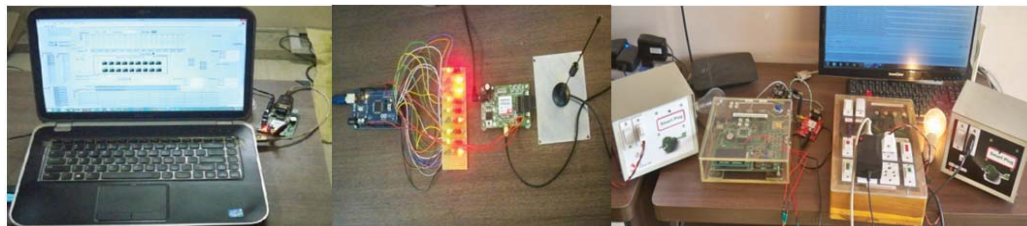

(c) Complete setup (Server, programmable load and HAN1)

Fig. 10 Programmable load and complete setup

The complete setup is shown in Figs. 10 (a) and (b). The front panel of the server that is made using LabVIEW, is shown in Figs. 10 (c) and 11. The actual consumption and Real Time Price currently used are also shown in it.

The values of total consumption of customer -1 and other customers (2-9) are stored in Ms-Excel files. The path for those files is clearly shown on the panel presented in Fig. 11.

A. Experimental Results

In this experimental work, two types of schedulable appliances are considered. One is type A (washing machine having power rating of 1 kW) and the other is type B (PHEV having power rating of 3 kW). Washing Machine and PHEV are given power through smart plugs A and B respectively. The algorithm shown in Fig. 9 can work on multiple off-peak periods during the day. In this work, only two off-peak periods are considered. First one is between 12:00 AM to 08:00 AM (for type B appliances having higher rated power) and another one is 09:00 AM to 4 p.m. (Type A appliances having lower rating of power). In the experimental work done here, four different types of cases are considered and it is proved that these results are very identical with the simulations results

obtained in [19].

1) Case-1

In this case, the appliances are allowed to run at any time without considering low priced slots. Any PAR reduction and cost minimization technique is not applied here. The PAR is 3.44 in this case. Value of PAR in this case is the highest among all the cases. This is shown in Fig. 12 (a).

2) Case-2

During the off-peak period at night between 12:00 AM to 08:00 AM, all the type B schedulable appliances are allowed to consume power during low priced time slots. Similarly, all the type A appliances are allowed to consume power during the second declared off-peak period between 09:00 AM to 16:00 PM. In this case, peak demand crosses the permissible limit of 22 kW. This shows the rebound peak. Fig. 12 (b) shows the experimental results which presents rebound peak in it. The PAR, in this case, is 2.94.

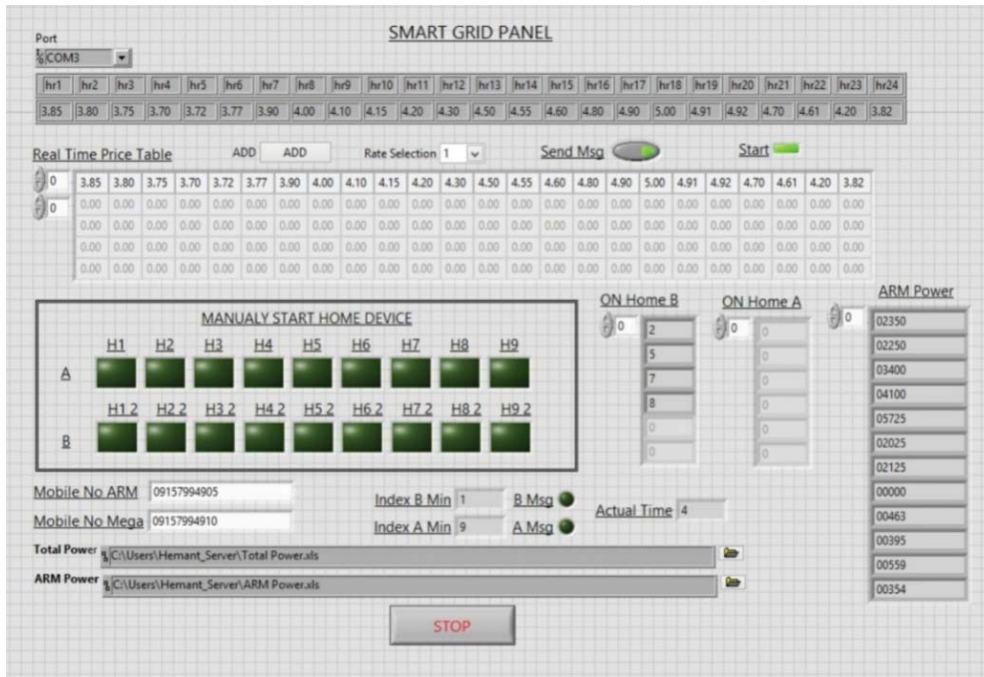
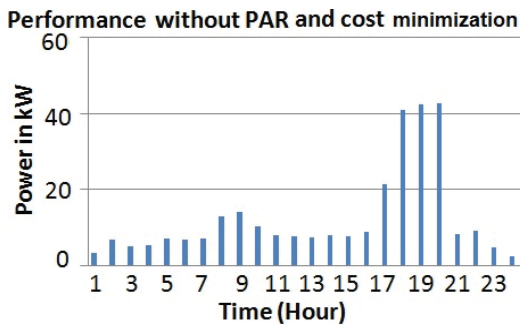

Fig. 11 Front panel of server

3) Case-3

In this case to avoid the rebound peak, HECs of all the customers run algorithm ($minimize C_t \cdot x_{i,k}^t$, as explained in Section II) to identify low-priced time slots.

After identifying such slots, HEC sends a request to the server. Considering the priority, power will be allowed during these identified slots. However, power is allowed only up to the permissible limit of the grid (22 kW). By this manner rebound peak condition does not occur. After completion of this process during one off-peak period, whole process is repeated during another off-peak period. Fig. 12 (c) shows the experimental results. The PAR is reduced to 1.73 in this case.



(a) Without PAR and energy cost minimization (Case-1)

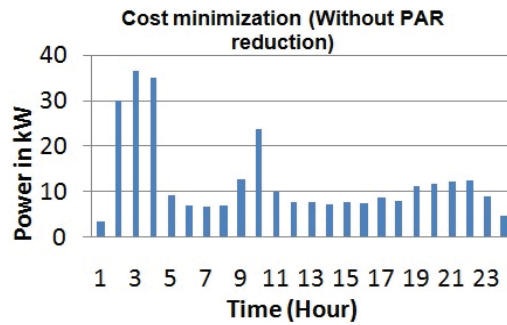

(b) Only energy cost minimization (Case-2)

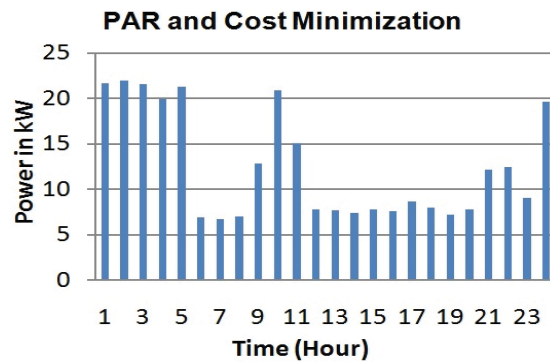

(c) Minimization of both PAR and energy cost (Case-3)

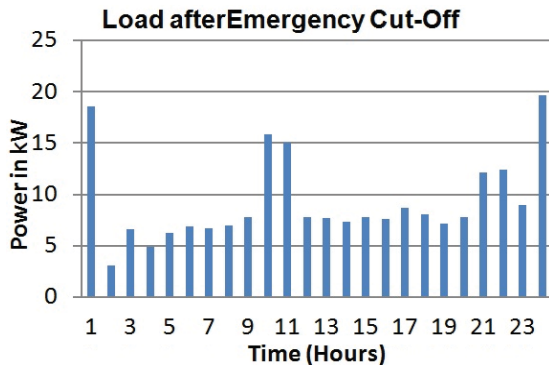

(d) Load on the grid after emergency cut-off (Case-4)

Fig. 12 Experimental results obtained for load on the grid in different cases

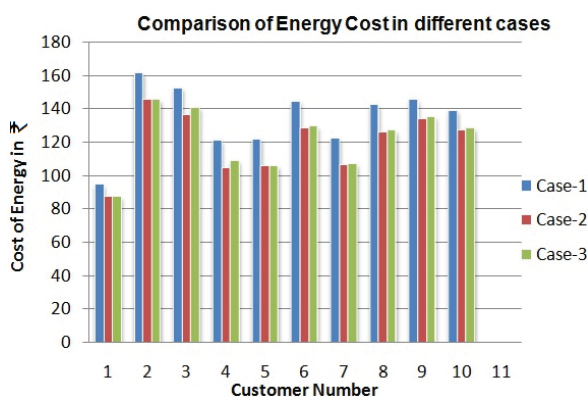

Fig. 13 Comparison of cost of energy consumed in different cases

4) Case-4

In this case, the setup works exactly as explained in case 3. If any fault occurs in power grid of a nearby region, some or all the schedulable appliances are forced to stop their operation by sending command (e.g. $SEBn\#$, $n=1, 2, \dots, n$). Using this emergency cutoff, more customers can get power to run required (or emergency) appliances until the fault is cleared. This is shown in Fig. 12 (d).

B. Comparison of Cost of Energy Consumed in Different Cases

Fig. 13 represents the comparison of the cost of energy consumed in different cases. In second case the cost of energy consumed is the lowest but this strategy should not be used as PAR, in this case, is 2.94. The strategy shown in a third case should be used as the PAR, in this case, is 1.72 which is the lowest among all cases.

VI. CONCLUSION

In this work, experimental work is carried for different cases for setup of a small smart grid. The algorithm for the utility server and HEC to minimize peak load, PAR and cost of energy are presented here. To avoid the rebound peak condition during the off-peak period, the server continuously monitors the current demand of the grid. When grid capacity

reaches near allowable capacity, it stops giving permission to remaining appliances. Remaining appliances get power in next time slots of the same off-peak period. During the day, more than one off-peak period can be handled by the algorithm designed here. This gives more flexibility and smoothen the process of PAR reduction. If we consider only the cost minimization problem, the PAR rises and the load shifts towards lowest energy cost duration as presented in Fig. 12 (b). As a result, the customer gets a benefit of lowest energy cost but peak load condition arises during that off-peak period and that results in the extra burden of power on the utility during that time slots. Although lowest energy cost is achieved in the second case, it is not an advisable solution because rebound peak condition occurs during the off-peak period. This condition is eliminated in the third case. In the third case, the value of PAR is 1.62 in simulation work and 1.73 in experimental work. Experimental result for third case is shown in Fig. 12 (c). Experimental results for cost of energy consumed by different customers in different cases are presented in Fig. 13.

Experimental results are very identical with simulation results. If more numbers of schedulable appliances are used, PAR can be reduced further. Although the emergency cut-off facility shown in the fourth case is not a part of PAR reduction process, it is very useful when the major fault occurs in the power station or nearby interconnected power grid. The strategy presented in this work can also be applied to commercial and industrial sector.

ACKNOWLEDGMENT

The authors gratefully acknowledge financial support from a Gujarat Council on Science and Technology (GUJCOST) for sanctioning research grant for this work. (Grant Number: GUJCOST/MRP/2014-15/266)

REFERENCES

- [1] Pathirikkat Gopakumar, M. Jaya Bharata Reddy, and Dushmantha Kumar Mohanta: 'Letter to the Editor: Stability Concerns in Smart Grid with Emerging Renewable Energy Technologies', *Electric Power Components and Systems*, Taylor and Francis, 42(3-4): pp 418-425, 2014, published online on 5th Feb, 2014.
- [2] Yu Wang, Shiwen Mao and A.M. Nelms: 'Online Algorithm for Optimal Real-Time Energy Distribution in the Smart Grid', *IEEE Transaction on Emerging Topics in Computing*, volume 1, pp 10-21, July 2013.
- [3] Mohamed E. El-Hawary: 'The Smart Grid—State-of-the-art and Future Trends', *Electric Power Components and Systems*, Taylor and Francis, 42(3-4):239-250, 2014.
- [4] Raja Verma, Patroklos Argyroudis, Donal O'Mahony: 'Matching Electricity Supply and Demand Using Smart Meters and Home Automation', *Conference on Sustainable Alternative Energy (SAE)*, IEEE PES/IAS, Sep 2009, pp 1-7.
- [5] Jonathan wang, Biviji M., W Maria Wang: 'Case Studies of Smart Grid Demand Response Programs in North America', *Innovative Smart Grid Technologies (ISGT) 2011*, IEEE PES, 17-19 Jan 2011, pp 1-5.
- [6] Suyang Zhou, Zhi Wu, Jianing Li and Xiao-ping Zhang: 'Real Time Energy Control Approach for Smart Home Energy Management System', *Electric Power Components and Systems*, Taylor and Francis, 42(3-4): pp 315-326, published online on 5th Feb, 2014.
- [7] Shalineeekishore, Lawrence V. Snyder: 'Control Mechanisms for Residential Electricity Demand in SmartGrids', *Smart Grid Communications (SmartGridComm)*, First IEEE International Conference on, Gaithersburg, MD, 4-6 October 2010, pp 443-448.

- [8] Chen-Chen, Shalineekishore, Lawrence V. Snyder: 'An Innovative RTP-Based Residential Power Scheduling Scheme for Smart Grids, International Conference on Acoustics, Speech and Signal Processing (ICASSP)', Prague, 22-27 May 2011, pp 5556-5569.
- [9] Amir-Hameed Mohsenian-Rad, Alberto Leon-garcia: 'Optimal Residential Load Control with Price Prediction in Real Time Electricity Pricing Environments', Smart Grid, IEEE Transactions on (Volume:1, Issue: 2), September 2010, pp 120-133.
- [10] Amir-Hameed Mohsenian-Rad, Vincent W.S. Wong, Juri Jatskewiich, Robert Schobber, et al: 'Autonomous Demand-Side Management based on Game-Theoretic Energy Consumption Scheduling for Future Smart Grid', IEEE Transactions on (Volume:1, Issue: 3), December 2010, pp 320-331.
- [11] Yu wang, Shiwen Mao and A.M. Nelms: 'Online Algorithm for Optimal Real-Time Energy Distribution in the Smart Grid', IEEE Transaction on Emerging Topics in Computing, volume 1, pp 10-21, July 2013.
- [12] Ye Yan, Yi Quin, Hamid Sharif and David Tipper: 'A Survey on Smart Grid Communication Infrastructures: Motivations, Requirements and Challenges', Communications Surveys and Tutorials, IEEE. Issue 99, p.p. 1-16., Feb 2012.
- [13] Zubair Md. Fadlullaf, Yousuke Nozaki, Akira Takeuchi and Nei Kato: 'A Survey of Game Theoretic Approaches in Smart Grid', International Conference on Wireless Communications and Signal Processing (WCSP), Nanjing, China, pp 1-4,9-11 Nov. 2011
- [14] Tarek Khalifa, Kshirasagar Naik and Amiya Nayak: 'A Survey of Communication Protocols for Automatic Meter Reading Applications', IEEE communications surveys & tutorials, vol. 13, NO. 2, second quarter 2011, p.p.168-182.
- [15] Chen-Chen, Shalineekishore, Lawrence V. Snyder: 'An Innovative RTP-Based Residential Power Scheduling Scheme for Smart Grids', International Conference on Acoustics, Speech and Signal Processing (ICASSP), pp 5556-5569, Prague, 22-27 May 2011.
- [16] Gang Xiong, Chen Chen, Shalineek Kishore, et al: 'Smart (In-home) Power Scheduling for Demand Response on the Smart Grid', Innovative Smart Grid Technologies (ISGT) 2011, IEEE, Jan 2011, p.p. 1-7.
- [17] Hengsongwang, Qi Huang: 'A Novel Structure for Smart Grid Oriented to Low-Carbon Energy', Innovative Smart Grid Technologies (ISGT) 2011, IEEE PES, pp. 1-8, 17-19 Jan 2011.
- [18] Shengnan Shao, Manisa Pipattanasomporn, and Saifur Rahman: 'Grid Integration of Electric Vehicles and Demand Response with Customer Choice', IEEE transactions on smart grid, vol. 3, no. 1, March 2012, pp 543-550.
- [19] Hemant Joshi, Vivek Pandya: 'Optimal RTP Based Power Scheduling for Residential Load in Smart Grid', Journal of the Institution of Engineers (India): Series B (Springer), p.p. 1-7, Oct 2014.
- [20] Dimitris Bertsimas, John N. Tsitsiklis: 'Introduction to Linear Optimization', Massachusetts Institute of Technology, Athena Scientific, Belmont, Massachusetts, USA, 1997, 1st edition, pp 1-20.

Hemant I. Joshi is a research fellow at Electrical Engineering Department, School of Technology, R K University, Rajkot, India. He is currently Lecturer in Electrical Engineering at Government Polytechnic, Himatnagar. He received B.E. (Electrical Engineering) and M. Tech (Power Electronics Machines and Drives) from Hemchandrachrya University, Nirma University in 1997 and 2010, respectively. He is having a teaching experience of 17 years at various premium engineering institutes of Gujarat. He has published 13 papers in Journals /conferences at international and National levels. His research interests include Multilevel Inverters, Various Power Converters, and Smart Power Scheduling Techniques in Smart Grid.

Vivek J. Pandya is currently an Associate Professor and Head of Electrical Engineering Department at School of Technology, PanditDeendayal Petroleum University (PDPU), Gandhinagar since 2011. He received B.E. (Electrical Engineering) and M. E. (Electrical Engineering) with specialization in power system engineering from B.V.M. Engineering College, Sardar Patel University, VallabhVidyanagar, India in 1995 and 2003, respectively. He obtained Ph. D from Faculty of Technology, Maharaja Sayajirao University of Baroda in 2009. During his doctoral work he carried out his research on protection issues of series compensated transmission lines. The focus of the work was to develop techniques to prevent maloperation (over reach) of distance relays when applied to Series Compensate Lines. The work proposed three techniques towards the solution of the problem based on detection of harmonic contents, spectral energy variations in voltage and current signals