

Sloshing Control in Tilting Phases of the Pouring Process

Maria P. Tzamtzi, and Fotis N. Koumboulis

Abstract—We propose a control design scheme that aims to prevent undesirable liquid outpouring and suppress sloshing during the forward and backward tilting phases of the pouring process, for the case of liquid containers carried by manipulators. The proposed scheme combines a partial inverse dynamics controller with a PID controller, tuned with the use of a “metaheuristic” search algorithm. The “metaheuristic” search algorithm tunes the PID controller based on simulation results of the plant’s linearization around the operating point corresponding to the critical tilting angle, where outpouring initiates. Liquid motion is modeled using the well-known pendulum-type model. However, the proposed controller does not require measurements of the liquid’s motion within the tank.

Keywords—Robotic systems, Controller design, Sloshing suppression, Metaheuristic optimization.

I. INTRODUCTION

MANY industrial applications, as for example metal casting and steel industries, comprise tasks where liquid transfer and pouring is required. A crucial design goal that has to be satisfied during these tasks is to prevent undesired liquid outpouring and to suppress liquid sloshing. This is necessary in order to avoid liquid loss or pouring of excessive amounts of liquid within the mold, as well as to keep safe, hygienic and clean the foundry environment. Moreover, liquid sloshing may cause excessive cooling of the molten metal and deterioration of the product quality due to contamination.

Several control design approaches, as for example input shaping control, application of time varying filter gain and hybrid shape approach, have been proposed in order to control liquid vibrations for several cases of liquid transfer and pouring (see for example [1]–[7]). These works differ also with respect to the mechanic structure which is used to transfer the liquid container. For example, in [1], [2] and [6], the case of a vehicle carrying a tank along a straight path has been studied, while in [4], [7] the tank is considered to be carried by robots. In other cases specifically constructed

pouring machines are considered [3], [5].

Sloshing control design meets problems mainly in the following three issues: a) modeling of the liquid’s motion within the tank, b) measuring the liquid’s displacement and c) actuating the liquid’s motion. With respect to modeling the liquid’s motion, a usually met approach, that aims to simplify modeling of liquid vibrations in liquid transfer and pouring systems, approximates the liquid’s motion using a pendulum-type model [1]–[3], [5]–[7]. More specifically, the liquid’s vibrations are approximated by the oscillations of a pendulum, whose mass and length are determined by the mass of the liquid and the natural frequency of liquid’s oscillations, respectively [2], [4].

Concerning the measurements of the liquid’s motion, there are several works which propose controllers that require measurements of the liquid’s oscillations [1], [2]. Since such measurements are not usually available in practice, control approaches free from this requirement have also been proposed [6], [7].

Finally, in several works, the liquid’s motion is considered to be indirectly actuated through appropriate rotation of the tank. In case of liquid transfer, the tank’s rotations are used exclusively to suppress sloshing. This case has been studied in [7], where a partial inverse dynamics controller combined with a heuristically tuned PID controller, have been successfully applied for sloshing suppression during liquid transfer.

However, during the pouring process, the tank has to rotate appropriately so as to cause or prevent liquid outpouring. More specifically, the pouring process is constituted in three phases, the forward tilting phase, the outpouring phase and the backward tilting phase. During the first phase, the tank tilts until it reaches the maximum critical angle at which no liquid outpouring takes place provided that the liquid’s surface remains horizontal. During the next phase, a small additional tilting takes place to cause liquid outpouring. When the desired amount of liquid has outpoured the tank, the tank tilts backward to the equilibrium position. This is the third and last phase of the pouring process. Hence, in these phases sloshing suppression has to be achieved simultaneously with command following for the tank’s rotation. Moreover, sloshing suppression during the two tilting phases is even more crucial, since sloshing may cause undesirable liquid overflow.

In the present work we propose a control design scheme that aims to prevent undesirable liquid outpouring and suppress sloshing during the forward and backward tilting

Manuscript received September 30, 2007. The present work is co-financed by the Hellenic Ministry of Education and Religious Affairs’ and the ESF of the European Union within the framework of the “Operational Programme for Education and Initial Vocational Training” (Operation “Archimedes-II”).

M. P. Tzamtzi is with the Department of Automation, Halkis Institute of Technology, 34400, Psahna, Evia, Greece (corresponding author, phone:+22280-99674; fax: +22280-99527, e-mail: tzamtzi@teihal.gr).

F. N. Koumboulis is with the Department of Automation, Halkis Institute of Technology, 34400, Psahna, Evia, Greece (e-mail: koumboulis@teihal.gr).

phases of the pouring process, for the case of a liquid container carried by a manipulator. The proposed scheme, which has a similar structure with that proposed in [7], combines a partial inverse dynamics controller with a PID controller, tuned with the use of a “metaheuristic” search algorithm that has been introduced in [8]. The “metaheuristic” search algorithm tunes the PID controller based on simulation results of the plant’s linearization around the operating point corresponding to the critical tilting angle, where outpouring initiates. Liquid motion is modeled using the well-known pendulum-type model. It is also important to note that the proposed controller does not require measurements of the liquid’s motion within the tank.

Section 2 presents the modeling equations of the automatic pouring system and determines the design goals that have to be satisfied by the control scheme. Section 3 presents the proposed control design approach. Finally, Section 4 presents simulation results from the application of the proposed controller to the automatic pouring system.

II. PROBLEM FORMULATION

A. Modeling Equations

Consider an automatic pouring system, consisting by an articulated robotic manipulator carrying the liquid container (Fig. 1 (see also [7])). Liquid pouring is accomplished by appropriately tilting the container, through an actuatable revolute joint that connects the tank with the robot’s end effector. The tank is firmly grasped by the robotic manipulator’s end effector.

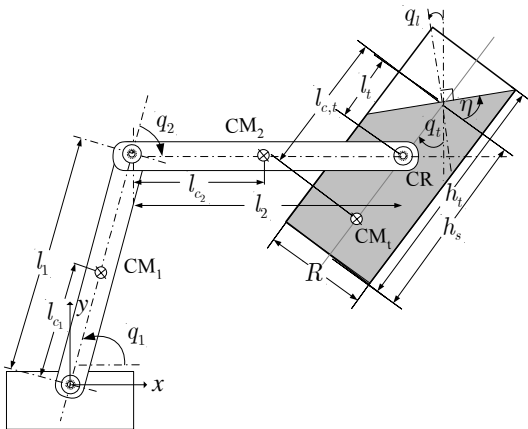

Fig. 1 Tilting phases of the pouring process

The pouring system is described by the following nonlinear dynamic model:

$$D(q(t))\ddot{q}(t) + C(q(t), \dot{q}(t))\dot{q}(t) + G(q(t)) = u(t) \quad (1)$$

where $q = [q_1 \ q_2 \ q_t \ q_t]^T$ denote the generalized

coordinates of the structure, with q_1 and q_2 being the generalized variables of the robotic manipulator, q_t the angle of the tank’s rotation with respect to the perpendicular axis and q_t the angle between the liquid’s free surface and the horizontal axis. Moreover, $u(t) = [u_1(t) \ u_2(t) \ u_3(t) \ 0]^T$, where $u_1(t)$, $u_2(t)$ and $u_3(t)$ denote the control torques that actuate the first manipulator joint, the second manipulator joint and the joint actuating the tank’s motion, respectively.

The matrices $D(q(t))$, $C(q(t), \dot{q}(t))$ and $G(q(t))$, with $D(q(t))$ being symmetric positive definite, are derived by the Euler-Lagrange modeling equations for robotic structures, taking into account the following simplifying considerations (see also [7]):

a) Liquid sloshing is neglected in directions that do not lie on the structure’s plane of motion.

b) The liquid container is represented by a single link, whose mass m_t and inertia I_t are equal to the corresponding parameters of the tank (Fig. 2). This link is modeled as an additional third link of the robotic manipulator, considering the size, the mass and the moment of inertia of the robot’s end-effector to be neglectable.

c) Liquid sloshing is modeled by a pendulum-type sloshing model [1] (Fig. 2 (see also [7])). That is we consider a pendulum as a fourth non-actuatable link of the robotic manipulator. The mass m_p of the pendulum is equal to the mass of the liquid. The torque applied to the pendulum due to the viscosity of the liquid and the friction between the liquid and the walls of the tank is equal to $-cl_p^2 \cos^2(q_t)(\dot{q}_t - \dot{q}_t)$, where c the equivalent coefficient of viscosity [1] and l_p the length of the pendulum.

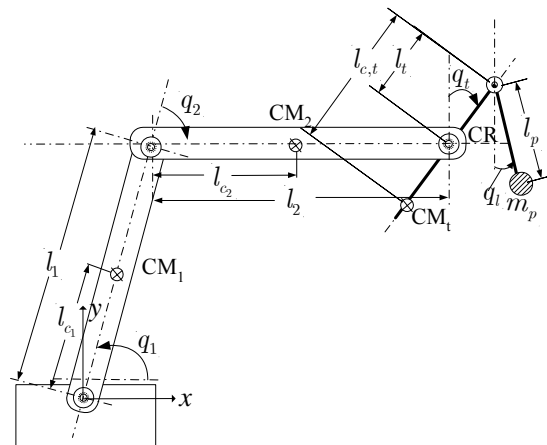

Fig. 2 Representation of liquid’s motion with a pendulum

It is obvious from the above discussion that the dynamic equations (1) may be derived using Euler-Lagrange modeling equations for a planar robotic manipulator, whose last two links represent the tank and the pendulum (see also

[7]). The last two joints of the manipulator are revolute joints. The control torque of the last joint is set identically equal to zero since the pendulum's motion is not actuatable. Finally, an additional torque equal to $-cl_p^2 \cos^2(q_t)(\dot{q}_t - \dot{q}_t)$ is considered to act on the last joint due to viscosity and friction. Note that these modeling steps may be used not only for the specific manipulator of Figure 1, but for any robotic manipulator that may be used to carry the tank.

The equivalent length l_p of the pendulum is determined based on the natural frequency given by the perfect fluid theory [2], [4]. Assuming the dimension of the sloshing mode to be equal to one, the natural frequency f_s is related to the liquid level h_s according to the relation [2], [4]

$$f_s = \frac{1}{2\pi} \sqrt{\frac{g\pi}{R} \tanh\left(\frac{\pi h_s}{R}\right)} \quad (2)$$

where R the distance between the walls of the tank. Then the length l_p is given by $l_p = \frac{g}{4\pi^2 f_s^2}$. Since the pendulum's length l_p depends on the liquid's level h_s , it follows that l_p may be considered to be constant provided that the angle between the liquid surface and the bottom of the tank remains sufficiently small. Otherwise the distribution of the water mass within the tank changes significantly and the natural frequency f_s should be computed from (2) using smaller values of h_s than that corresponding to the equilibrium state. However, the function at the right hand side of (2) saturates for sufficiently large values of h_s . Thus, the natural frequency f_s and consequently the length l_p remain practically invariant provided that h_s remains sufficiently large. Indeed, it can be verified using the parameters of Table I, that the equilibrium value of the liquid's level is within the saturation area of the natural frequency f_s . In the following we consider the case where tilting of the tank does not produce significant variations on the natural frequency of liquid's sloshing, hence the pendulum's length will be considered to remain constant.

TABLE I
PARAMETERS OF THE LIQUID TRANSFER STRUCTURE

NOMENCLATURE		
Parameter	Value	Physical Meaning
m_1	10[kg]	Mass of the 1 st link [9]
m_2	10[kg]	Mass of the 2 nd link [9]
l_1	1[m]	Length of the 1 st link [9]
l_2	1[m]	Length of the 2 nd link [9]
I_1	2[kg·m ²]	Moment of inertia of the 1 st link [9]
I_2	2[kg·m ²]	Moment of inertia of the 2 nd link [9]

l_{c1}	0.5[m]	Distance of the 1 st link's center of mass from the 1 st joint [9]
l_{c2}	0.5[m]	Distance of the 2 nd link's center of mass from the 2 nd joint [9]
m_t	1.68[kg]	Tank's mass
l_t	0.033[m]	Distance between the tank's center of rotation (CR) and the free surface of the liquid
l_{ct}	0.113[m]	Distance of the tank's center of mass (CM) from the free surface of the liquid
I_t	$7.193 \cdot 10^{-3}$ [kg·m ²]	Tank's moment of inertia
R	0.14[m]	Distance between the walls of the tank [1]
h_t	0.17[m]	Height of the tank
h_s	0.14[m]	Liquid level [1]
m_p	2.744[kg]	Pendulum's mass [1]
l_p	0.0442[m]	Pendulum's length [1]
c	1.88[N·sec/m]	Liquid coefficient of viscosity [1]
g	9.81[m/sec ²]	Gravity acceleration

B. Design Requirements

The system described in the previous section may be used for automatic liquid transfer and pouring in several industrial applications as for example metal casting. Liquid pouring is achieved by appropriately tilting forward the container until the prescribed amount of metal outpours into the mold. The task of pouring comprises three phases. During the first phase the tank is carried at the position of the mold that has to be poured with the liquid. At the same time the tank tilts forward up to the position where the liquid surface reaches the edge of the tank. During the second phase the tank tilts more forward until the prescribed amount of metal has outpoured into the mold. At the third and last phase the robot back-tilts the container to the equilibrium position. The objectives of any control system designed for such applications are the following:

I) To avoid undesired liquid outpouring during the first and the third phase. This is necessary in order to avoid liquid loss or pouring of excessive amounts of liquid within the mold, as well as to keep safe, hygienic and clean the foundry environment.

II) To suppress liquid sloshing during the first and the third phase, since sloshing may cause excessive cooling of the molten metal and deterioration of the product quality due to contamination.

III) To achieve sufficiently fast execution of the pouring

task in order to avoid metal cooling and to increase productivity.

IV) To avoid liquid sloshing during the second phase, since this may cause outpouring of excessive amounts of liquid or even liquid loss outside the mold.

In the following sections we study the design of an automatic control system aiming to achieve the design goals I, II and III, that concerns the first and the third phase, during which the amount of liquid within the tank remains constant. The second phase, requires special treatment, since modeling of the plant and controller design for this phase should take into account time variation of the amount of liquid within the tank.

III. CONTROL DESIGN

In [7] a control design scheme comprising a partial inverse dynamics controller with a heuristically tuned PID controller has been proposed. The design goal of that scheme was to keep the pendulum's oscillations, induced by the movement of the robot's links, sufficiently close to the equilibrium perpendicular position by appropriately rotating the tank. It is obvious that such a controller cannot serve adequately the needs of the pouring task, where both the tank's position and rotation have to follow desired trajectories, while simultaneously suppressing liquid sloshing.

In the following, we propose a design scheme with similar structure, which is specifically oriented to serve the design requirements I, II and III, presented in Subsection II.B, during the first and the third phase of the pouring task. The design scheme exploits measurements of the manipulator links and the container position and velocity variables, but it does not use measurements of the pendulum's position and velocity, which as already mentioned are not considered to be measurable.

The proposed partial inverse dynamics controller is described by the equation (see also [7])

$$\begin{bmatrix} u_1 \\ u_2 \\ u_3 \end{bmatrix} = \bar{C}(\bar{q}, \dot{\bar{q}})\dot{\bar{q}} + \bar{G}(\bar{q}) + \bar{D}(\bar{q}) \begin{bmatrix} \ddot{q}_{d,1} + k_1(\dot{q}_{d,1} - \dot{q}_1) + k_2(q_{d,1} - q_1) \\ \ddot{q}_{d,2} + k_1(\dot{q}_{d,2} - \dot{q}_2) + k_2(q_{d,2} - q_2) \\ -k_1\dot{q}_t - k_2q_t + k_2w_3 \end{bmatrix} \quad (3)$$

where $\bar{q} = [q_1 \quad q_2 \quad q_t]^T$, $w_3(t)$ is an auxiliary input variable,

$$\bar{D}(\bar{q}) = [d_{i,j}([\bar{q}^T \quad 0]^T)], \quad i, j = 1, 2, 3$$

$$\bar{C}(\bar{q}, \dot{\bar{q}}) = [c_{i,j}([\bar{q}^T \quad 0]^T, [\dot{\bar{q}}^T \quad 0]^T)], \quad i, j = 1, 2, 3$$

$$\bar{G}(\bar{q}) = [G_i([\bar{q}^T \quad 0]^T)], \quad i = 1, 2, 3$$

while $q_{d,1}(t)$ and $q_{d,2}(t)$ denote the desired trajectories for the first and the second manipulator's joint variables, respectively. Note that $q_{d,1}(t)$ and $q_{d,2}(t)$ are determined using inverse kinematics, so as to achieve the desired motion of the tank.

The partial inverse dynamics controller (3) would achieve linearization and input/output decoupling of the liquid's transfer structure dynamics in the ideal case where the liquid's surface would remain always horizontal. The controller parameters k_1 and k_2 are appropriately selected so that they would achieve closed-loop stability and sufficiently small settling time in the aforementioned ideal case. Note that the proposed partial inverse dynamics controller (3) differs from the one proposed in [7], since the controller in [7] was designed to achieve linearization and input/output decoupling provided that the liquid surface does not oscillate with respect to the tank.

It is important to note at this point, that despite the fact that the nonlinear system (1) is feedback linearizable, lack of measurements of the liquid's motion prevents the application of a fully inverse dynamic controller. However, the proposed partial inverse dynamic controller would perform satisfactorily, provided that the liquid's surface remains sufficiently close to the horizontal axis.

Consider now an additional PID controller that drives the auxiliary input variable $w_3(t)$:

$$w_3(t) = f_1 e_t(t) + f_2 \dot{e}_t(t) + f_3 \int_0^t e_t(\tau) d\tau \quad (4)$$

where $e_t(t) = q_{d,t}(t) - q_t(t)$ denotes the tracking error between the desired trajectory $q_{d,t}$ for the tank's rotation and the corresponding variable q_t , and $f_i, i = 1, 2, 3$ are the controller parameters to be determined.

In order to present the design approach used to tune the PID controller parameters, consider the linearization of the closed-loop system produced by the application of controller (3) to system (1):

$$\dot{x}(t) = Ax(t) + Br(t) \quad (5)$$

where $x(t) = [x_i(t)], i = 1, \dots, 8$, with $x = [e_1, e_2, \delta q_t, q_t, \dot{e}_1, \dot{e}_2, \delta \dot{q}_t, \dot{q}_t]^T$, $e_i = q_i - q_{d,i}$, $i = 1, 2$ denote the tracking errors between the generalized variables q_1 and q_2 and their corresponding desired trajectories, the control variable is equal to $r(t) = \delta w_3(t)$, while the matrices of the linearized model are given by the following relations

$$A = \begin{bmatrix} 0_{2 \times 2} & 0_{2 \times 2} & I_2 & 0_{2 \times 2} \\ 0_{2 \times 2} & 0_{2 \times 2} & 0_{2 \times 2} & I_2 \\ -k_2 I_2 & \bar{A}_1 & -k_1 I_2 & \bar{A}_2 \\ 0_{2 \times 2} & \bar{A}_3 & 0_{2 \times 2} & \bar{A}_4 \end{bmatrix} \quad (6a)$$

$$B^T = \begin{bmatrix} 0_{1 \times 4} & \bar{B}_1^T & \bar{B}_2^T \end{bmatrix} \quad (6b)$$

where I_2 denotes the 2×2 identity matrix, $\bar{A}_i \in \mathbb{R}^{2 \times 2}$, $i = 1, \dots, 4$ and $\bar{B}_1, \bar{B}_2 \in \mathbb{R}^{2 \times 1}$. The state space description (5) is the linearization of the closed-loop system around the operating point $[x_0, w_{3,0}]$, with $x_0 = [0, 0, q_{t,0}, 0, 0, 0, 0]^T$ and $w_{3,0} = q_{t,0}$, where $q_{t,0}$ a nominal value for the rotation of the tank with respect to the perpendicular axis. Thus, the variables δq_t and δw_3 are defined as $\delta q_t(t) = q_t(t) - q_{t,0}$ and $\delta w_3(t) = w_3(t) - w_{3,0}$.

It is obvious from equations (6), that for the linearized system (5) the behavior of the variables δq_t and $q_i(t)$ is not affected by the variables $e_1(t)$ and $e_2(t)$.

The parameters $f_i, i = 1, 2, 3$ of the PID controller (4) are determined using a metaheuristic search algorithm introduced in [8], which is appropriately adjusted to meet the design requirements of the pouring task. The metaheuristic algorithm performs repeatedly random search within an appropriate search area, which has the form of a hyperrectangle in the controller parameters space. At each repetition of the search, simulation is performed for the closed-loop system produced by the application of controller (4) to the linearized system (5). The simulation results are used to test if specific constraints are satisfied. Among the controllers that satisfy the constraints, the algorithm selects the controller that minimizes the settling time of the variable $\eta(t) = q_t(t) - q_i(t)$. The search area in the controller parameters space, changes adaptively during the execution of the algorithm ([8]).

The constraints that have to be satisfied by the candidate PID controller (4) are given in the following:

a) The closed-loop system resulting from the application of controller (4) to the linearized system (5) has to be stable.

b) The absolute value of the imaginary part of its poles has to be less than a threshold value i_m .

c) As the liquid surface oscillates due to sloshing, the absolute value of the angle $\eta(t) = q_t(t) - q_i(t)$ between the liquid's surface and the bottom of the tank should remain always smaller than the critical value η_c where liquid outpouring would initiate. As it may readily be verified by Figure 1, this critical value is given by

$$\eta_c = \tan^{-1} \left(\frac{2(h_t - h_s)}{R} \right) \quad (7)$$

where h_s the liquid level at the equilibrium position, h_t the height of the tank and R the distance between the walls of the tank. Hence the applied controller should succeed to satisfy the condition

$$|\eta(t)| \leq \eta_c \quad (8)$$

d) The tank should not tilt beyond the critical angle, where liquid outpouring would initiate in the ideal case when no liquid sloshing occurs, i.e. when the liquid's surface remains horizontal ($q_t(t) = 0$). Hence the applied controller should succeed to satisfy the condition

$$|q_t(t)| \leq \eta_c \quad (9)$$

e) Finally, the applied controller should succeed to keep the torques applied by the joint actuators within prespecified limits (see also [7]), i.e. $|u_i(t)| \leq u_{p,i}, i = 1, 2, 3$. These upper bounds are determined by the characteristics of the actuators used to drive the joints.

Since the closed-loop system is designed to be stable, according to constraint (a), it is obvious that minimizing the settling time for the variable $\eta(t) = q_t(t) - q_i(t)$, achieves sufficiently fast settling for both variables $q_t(t)$ and $q_i(t)$.

As already mentioned, the linearized system (5) approximates sufficiently the behavior of the nonlinear system, provided that the system's state and control variables remain sufficiently close to the corresponding nominal operating point. Since the system's performance becomes critical as the tank's angle of rotation approaches the critical value η_c , it is obviously beneficial to apply the metaheuristic search algorithm so as to design a PID controller, that achieves the aforementioned design goals for the linearized system (5) derived for the nominal operating point corresponding to

$$q_{t,0} = w_{3,0} = \eta_c \quad (10)$$

Before ending this section, it is necessary to clarify certain details concerning the current implementation of the metaheuristic optimization algorithm. The critical value η_c is set for our case, according to (7) and Table I, equal to 0.404. The threshold value i_m imposed on the value of the closed-loop poles imaginary part is set equal to 15. The upper bounds for the control variables are estimated based on the maximum torque values required to compensate the weight forces implied on the two links, the tank and the liquid ([7]) and they are set equal to $u_{p,1} = 572.79$, $u_{p,2} = 191.69$ and $u_{p,3} = 12.96$.

The inverse dynamics controller parameters k_1 and k_2 are selected equal to 11 and 30, respectively. These values correspond to roots of the polynomial $s^2 + k_1 s + k_2$ equal to

-5 and -6, which can achieve sufficiently fast asymptotic tracking for the generalized variables q_1 and q_2 .

The initial search area for the PID controller parameters is given by $-1 \leq f_1 \leq 1$, $-k_1/k_2 \leq f_2 \leq k_1/k_2$ and $-1 \leq f_3 \leq 1$. The widths of these search areas for f_1 and f_2 are selected equal to the corresponding stability margins of the polynomial $s^2 + (k_1 + k_2 f_2)s + (k_2 + k_2 f_1)$ [7]. The latter polynomial would be the characteristic polynomial of the linear dynamic equation that would govern the behavior of the tank's rotation q_t at the closed-loop system resulting after the application of controllers (3) and (4) with $f_3 = 0$, provided that the liquid surface remains horizontal. The width of the initial search areas for f_3 is selected equal to that of f_1 .

The simulations of the closed-loop linearized system, which are used by the search algorithm to select a suboptimal PID controller are performed assuming the following initial values of the state variables

$$\delta q_t(0-) = \eta_c / 2 = 0.202[\text{rad}], \quad q_t(0-) = \eta_c / 12 = 0.033[\text{rad}] \\ \delta \dot{q}_t(0-) = \pi / 32[\text{rad/second}], \quad \dot{q}_p(0-) = \pi / 64[\text{rad/second}]$$

The external command for the tank's rotation, drives the tank from the aforementioned initial position up to the critical tilting angle. Thus the controller is tuned using simulation results for forward tilting.

The desired trajectories for the robot's generalized variables are given by:

$$q_{d,1}(t) = \begin{cases} 0.125\pi(t^2 + 2), & 0 \leq t \leq 1 \\ 0.125\pi(-t^2 + 4t), & 1 \leq t \leq 2 \end{cases} \\ q_{d,2}(t) = \begin{cases} 0.1\pi(t^2 - 2), & 0 \leq t \leq 1 \\ 0.1\pi(-t^2 + 4t - 4), & 1 \leq t \leq 2 \end{cases}$$

The aforementioned desired trajectories imply that the links of the manipulators perform accelerated rotating motion with constant angular acceleration for $0 \leq t \leq 1$ and decelerated rotating motion with constant angular deceleration for $1 \leq t \leq 2$.

The application of the metaheuristic optimization algorithm presented in [8] with the above parameters, resulted in the determination of a PID controller of the form (4) with $f_1 = 1.8566$, $f_2 = 2.4191$, $f_3 = 0.5634$.

IV. SIMULATION RESULTS

In the following, the performance of the proposed control scheme is illustrated through simulation results derived from its application to the nonlinear system (1).

The simulation results are derived for the case where elevation of the tank takes place simultaneously with tank tilting. More specifically, we consider the case where the point

at which the manipulator grasps the tank is elevated through a straight path from the point with coordinates (1,1) at $t = 0$ to the point with desired coordinates (1.27,1.27) at $t = 2$. Let $x_d(t)$ and $y_d(t)$ denote the desired coordinates of the point at which the manipulator grasps the tank. Then these are determined by the equations:

$$x_d(t) = 1 + 0.5(1.8 \cos(\pi/4) - 1)\alpha(t) \\ y_d(t) = 1 + 0.5(1.8 \sin(\pi/4) - 1)\alpha(t) \\ \alpha(t) = (3t^5 - 15t^4 + 20t^3)/8$$

which describe the desired motion with initial and final velocities and accelerations equal to zero. The corresponding desired trajectories for the robotic manipulator's generalized variables q_1 and q_2 are determined by solving the following inverse kinematics equations:

$$l_1 \cos(q_{d,1}(t)) + l_2 \cos(q_{d,1}(t) + q_{d,2}(t)) = x_d(t) \\ l_1 \sin(q_{d,1}(t)) + l_2 \sin(q_{d,1}(t) + q_{d,2}(t)) = y_d(t)$$

The initial conditions for the state variables of system (1), used for simulating forward tilting of the tank (first phase of pouring task), are considered to be:

$$q_1(0-) = \pi/2[\text{rad}], \quad q_2(0-) = -\pi/2[\text{rad}], \\ q_t(0-) = 0.01[\text{rad}], \quad q_p(0-) = 0.02[\text{rad}], \\ \dot{q}_1(0-) = 0[\text{rad/second}], \quad \dot{q}_2(0-) = 0[\text{rad/second}], \\ \dot{q}_t(0-) = 0.05[\text{rad/second}], \quad \dot{q}_p(0-) = -0.02[\text{rad/second}].$$

These initial conditions imply that the tank and the pendulum have an initial deviation from the perpendicular equilibrium position, as well as initial velocities, probably due to an external disturbance.

The simulation results for the case of forward tank tilting, which corresponds to the first phase of the pouring task, are presented in Figs. 3-12. Figs. 3 and 4 present the closed-loop trajectories for the two first joints, while Fig. 5 presents the motion of the point at which the manipulator grasps the tank. It is obvious from Figs. 3-5 that the two first joints achieve perfect tracking of the desired trajectories, without being affected by the vibrations of the tank and the liquid. Figs. 6 and 7 present the closed-loop trajectories for the rotations of the tank and the pendulum, while Figs. 8 and 9 illustrate the variables $q_t - (-\eta_c)$ and $\eta(t) - \eta_c$. It is obvious from Figures 6-9, that constraints (8) and (9) are satisfied, which implies that undesired liquid outpouring is avoided. Moreover liquid sloshing is sufficiently suppressed. Finally, from Figures 10-12, which present the control torques applied at the joints of the manipulator by the proposed controller, it is obvious that the applied control scheme satisfies the actuator constraints.

Figs. 13 and 14 present the performance of the variables $q_t - (-\eta_c)$ and $\eta(t) - \eta_c$ for the case of backward tilting the

tank, which is the third phase of the pouring process. It is obvious from Figs. 13-14, that constraints (8) and (9) are also satisfied for this case.

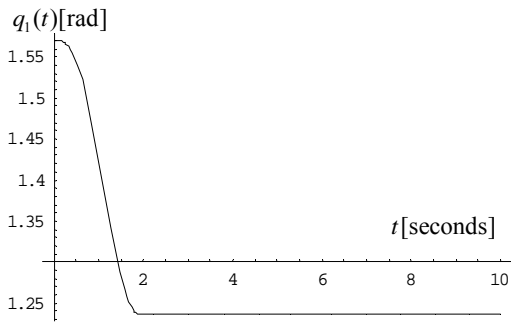

Fig. 3 Closed-loop values for $q_1(t)$ (forward tilting)

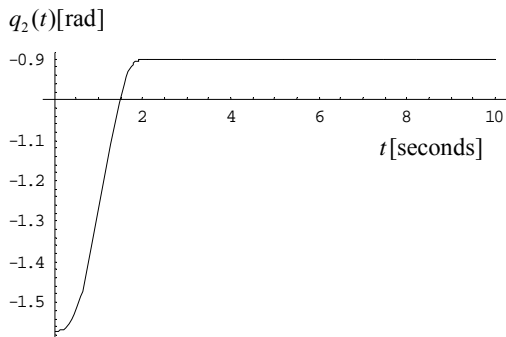

Fig. 4 Closed-loop values for $q_2(t)$ (forward tilting)

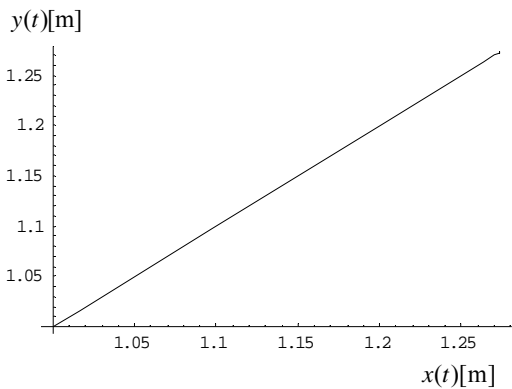

Fig. 5 Motion of the point at which the manipulator grasps the tank (forward tilting)

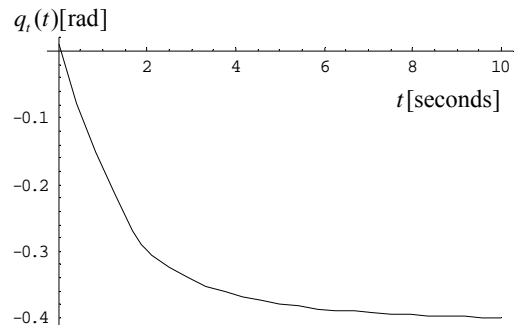

Fig. 6 Closed-loop values for $q_1(t)$ (forward tilting)

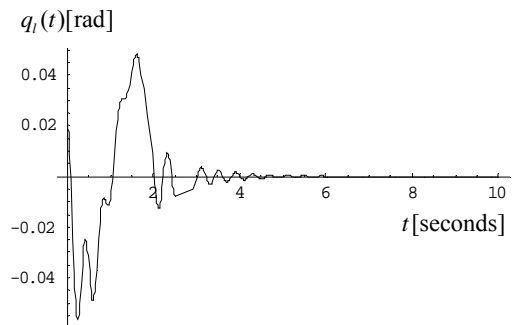

Fig. 7 Closed-loop values for $q_1(t)$ (forward tilting)

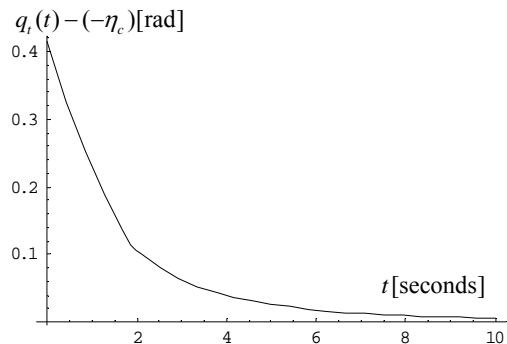

Fig. 8 Closed-loop values for $q_1(t) - (-\eta_c)$ (forward tilting)

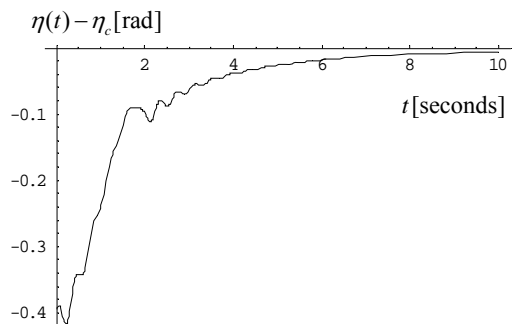
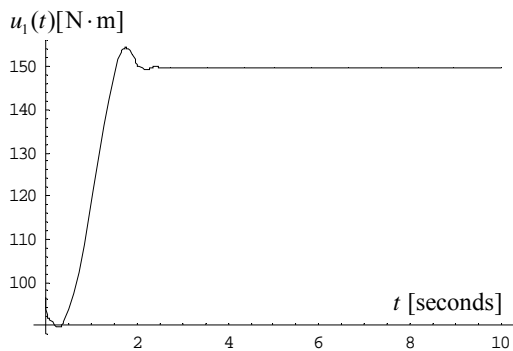
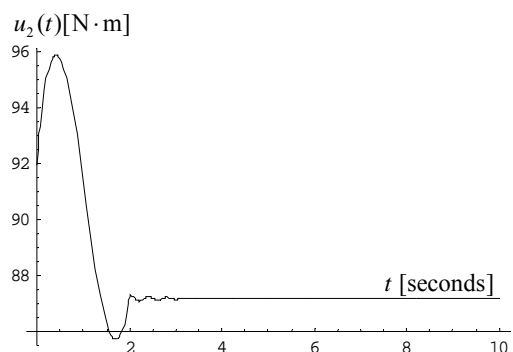
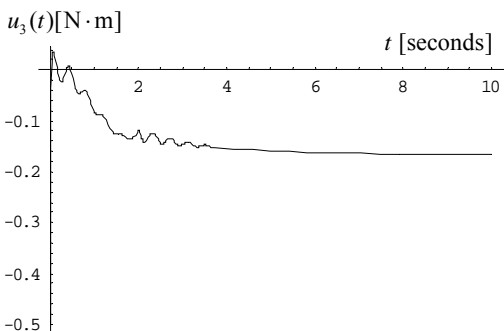
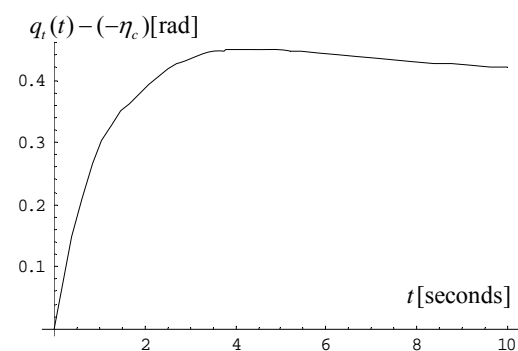
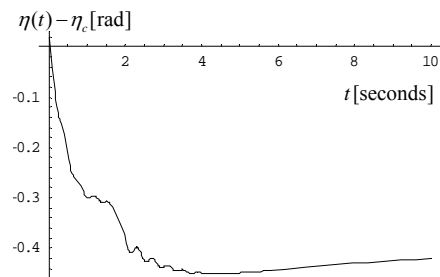

Fig. 9 Closed-loop values for $\eta(t) - \eta_c$ (forward tilting)

Fig. 10 Closed-loop values for $u_1(t)$ (forward tilting)Fig. 11 Closed-loop values for $u_2(t)$ (forward tilting)Fig. 12 Closed-loop values for $u_3(t)$ (forward tilting)Fig. 13 Closed-loop values for $q_i(t) - (-\eta_c)$ (backward tilting)Fig. 14 Closed-loop values for $\eta(t) - \eta_c$ (backward tilting)

V. CONCLUSION

In the present work, we have studied the case of an automatic pouring system, where the liquid container is carried by a manipulator. We propose a two stage control design scheme, combining a partial inverse dynamics controller with a heuristically tuned PID controller. The partial inverse dynamics controller mainly contributes towards the achievement of command following for the manipulator's generalized variables, so as to achieve the desired positioning of the tank. The PID controller contributes to achieve command following for the tank's rotation and simultaneously suppress sloshing. The proposed scheme concerns the forward and backward tilting phases of the pouring process and succeeds to prevent undesirable liquid outpouring, without requiring measurements of the liquid's motion within the tank. The performance of the proposed control scheme has been illustrated through simulation results.

REFERENCES

- [1] K. Yano, S. Higashikawa and K. Terashima, "Motion control of liquid container considering an inclined transfer path," *Control Engineering Practice*, vol. 10, pp. 465-472, 2002.
- [2] K. Yano and K. Terashima, "Robust liquid container transfer control for complete sloshing suppression," *IEEE Trans. on Control Systems Technology*, vol. 9, no. 3, pp. 483-493, 2001.
- [3] K. Terashima, M. Hamaguchi and K. Yamaura, "Modeling and input shaping control of liquid vibration for an automated pouring system," in *Proc. of the 35th Conf. on Decision and Control*, Kobe, Japan, 1996, pp. 4844-4850.
- [4] K. Yano, T. Toda and K. Terashima, "Sloshing suppression control of automatic pouring robot by hybrid shape approach," in *Proc. of the 40th IEEE Conf. on Decision and Control*, Orlando, Florida, USA, 2001, pp. 1328-1333.
- [5] K. Terashima and K. Yano, "Sloshing analysis and suppression control of tilting-type automatic pouring machine," *Control Engineering Practice*, vol. 9, pp. 607-620, 2001.
- [6] M.P. Tzamtzi, F.N. Koumboulis, N.D. Kouvakas, G.E. Panagiotakis, "A Simulated Annealing Controller for Sloshing Suppression in Liquid Transfer", in *Proc. of the 14th Med. Conf. on Control and Automation*, Italy, 2006.
- [7] M.P. Tzamtzi, F.N. Koumboulis, "A Two Stage Robot Control for Liquid Transfer", *12th IEEE Conf. on Emerging Techn. and Factory Autom.*, Patras, Greece, 2007, pp. 1324-1333.
- [8] F.N. Koumboulis, M.P. Tzamtzi, "A metaheuristic approach for controller design of multivariable processes", *12th IEEE Conf. on Emerging Techn. and Factory Autom.*, Patras, Greece, 2007, pp. 1429-1432.
- [9] B. Yao, W.B. Gao, S.P. Chan and M. Cheng, "VSC coordinated control of two manipulator arms in the presence of environmental constraints", *IEEE Trans. Automat. Contr.*, vol. 37, pp. 1806-1812, 1992.