

# Robust Sensorless Speed Control of Induction Motor with DTFC and Fuzzy Speed Regulator

Jagadish H. Pujar, S. F. Kodad

**Abstract**—Recent developments in Soft computing techniques, power electronic switches and low-cost computational hardware have made it possible to design and implement sophisticated control strategies for sensorless speed control of AC motor drives. Such an attempt has been made in this work, for Sensorless Speed Control of Induction Motor (IM) by means of Direct Torque Fuzzy Control (DTFC), PI-type fuzzy speed regulator and MRAS speed estimator strategy, which is absolutely nonlinear in its nature. Direct torque control is known to produce quick and robust response in AC drive system. However, during steady state, torque, flux and current ripple occurs. So, the performance of conventional DTC with PI speed regulator can be improved by implementing fuzzy logic techniques. Certain important issues in design including the space vector modulated (SVM) 3- $\Phi$  voltage source inverter, DTFC design, generation of reference torque using PI-type fuzzy speed regulator and sensor less speed estimator have been resolved. The proposed scheme is validated through extensive numerical simulations on MATLAB. The simulated results indicate the sensor less speed control of IM with DTFC and PI-type fuzzy speed regulator provides satisfactory high dynamic and static performance compare to conventional DTC with PI speed regulator.

**Keywords**—Sensor-less Speed Estimator, Fuzzy Logic Control (FLC), SVM, DTC, DTFC, IM, fuzzy speed regulator.

## I. INTRODUCTION

THE fuzzy logic control technique has been an active research topic in automation and control theory since the work of Mamdani proposed in 1974 based on the fuzzy sets theory of Zadeh, proposed in 1965 to deal with the system control problems which are not easy to be modeled [27]. The concept of FLC is to utilize the qualitative knowledge of a system to design a practical controller. For a process control system, a fuzzy control algorithm embeds the intuition and experience of an operator designer and researcher.

The fuzzy control doesn't need accurate mathematical model of a plant, and therefore, it suits well to a process where the systems with uncertain or complex dynamics. Of course, fuzzy control algorithm can be developed by adaptation based on learning and fuzzy model of the plant [31]. Fuzzy control using linguistic information possesses several advantages such

as robustness, model-free, universal approximation theorem and rules-based algorithm [28]. Recent literature has explored the potentials of fuzzy control for machine drive application [32] [33]. It has been shown that a properly designed direct fuzzy controller can outperform conventional proportional integral derivative (PID) controllers [33].

In recent years significant advances have been made on the sensorless control of IM. One of the most well-known methods used for control of AC drives is the Direct Torque Control (DTC) developed by Takahashi in 1984 [29]. DTC of IM is known to have a simple control structure with comparable performance to that of the field-oriented control (FOC) techniques developed by Blaschke in 1972 [35]. Unlike FOC methods, DTC techniques require utilization of hysteresis band comparators instead of flux and torque controllers. To replace the coordinate transformations and pulse width modulation (PWM) signal generators of FOC, DTC uses look-up tables to select the switching procedure based on the inverter states [29].

Direct torque control (DTC) of induction motors (IMs) requires an accurate knowledge of the magnitude and angular position of the controlled flux. In DTC, the flux is conventionally obtained from the stator voltage model, using the measured stator voltages and currents. This method, utilizes open loop pure integration suffering from the well known problems of integration effects in digital systems, especially at low speeds operation range.

In the last decade, many researches have been carried on the design of sensorless control schemes of the IM. Most methods are basically based on the Model Reference Adaptive System schemes (MRAS) [7] [8]. In [9] the authors used a reactive-power-based-reference model derived from (Garcia-Correda and Robentsen, 1999) in both motoring and generation modes but one of the disadvantages of this algorithm is its sensitivity to detuning in the stator and rotor inductances. The basic MRAS algorithm is very simple but its greatest drawback is the sensitivity to uncertainties in the motor parameters. Another method based on the Extended Kalman Filter (EKF) algorithm is used [10] [11] [12]. The EKF is a stochastic state observer where nonlinear equations are linearized in every sampling period. An interesting feature of the EKF is its ability to estimate simultaneously the states and the parameters of a dynamic process. This is generally useful for both the control and the diagnosis of the process. In [12] the authors used the EKF algorithm to simultaneously

Jagadish H. Pujar is a Research Scholar at JNTU, Anantapur & Faculty with the Department of EEE, BVB College of Engg., & Tech., Hubli-580 031, India (corresponding author phone: 0836-2378242; fax: 0836-2374985; e-mail: jhpujar@gmail.com).

Dr. S. F. Kodad is a Director, with the Krishnamurthy Institute of Tech. & Engg., Hyderabad, Andhra Pradesh, India (e-mail: kodadsf@rediffmail.com).

estimate variables and parameters of the IM in healthy case and under different IM faults. [7-13] used the Luenberger Observer for state estimation of IM. The Extended Luenberger Observer (ELO) is a deterministic observer which also linearizes the equations in every sampling period. There is other type of methods for state estimation that is based on the intelligent techniques is used in the recent years by many authors [14] [15] [16]. Fuzzy logic and neural networks has been a subject of growing interest in recent years. Neural network and fuzzy logic algorithms are quite heavy for basic microprocessors. In addition, several papers provide sensorless control of IM that are based on the variable structure technique [17] [18] and the High Gain Observer (HGO) [19] that is a powerful observer that can estimate simultaneously variables and parameters of a large class of nonlinear systems and doesn't require a high performance processor for real time implementation.

DTC improves the induction machine controller dynamic performance and reduces the influence of the parameter variation during the operation [20]. The pure integration method used in the classical DTC of IMs suffers from the well known problems of integration especially at low speed operation range is replaced in this work by the EKF. This observer is used to estimate the stator currents, the rotor flux linkages, the rotor speed and the stator resistance. The speed estimation is affected by parameter variations especially the stator resistance due to temperature rises particularly at low speeds [21].

The main objective of this research paper is to develop the digital simulation software on MATLAB simulink platform for sensorless direct torque fuzzy control of SVM inverter fed IM drive with PI-type fuzzy speed regulator aimed to develop sensorless speed control by means of MRAS speed estimator and to reduce the ripples at all modulation indices and also to improve the speed regulation performance, under transient and steady state uncertainties caused by the variation in load torque.

## II. NEED FOR ELECTRICAL DRIVES AND THEIR CONTROL

To distinguish Electrical drives play an important part as electromechanical energy converters in transportation, materials handling and most production processes. About 50 percents of electrical energy produced has used in electric drives today. Today still about 75 percent of all electric drives run at constant speed because there is not much need for speed control except for starting, stopping and protection. However, there is a still smaller 25 percent group of applications, with very fast annual expansion rate where the torque and speed must be varied to match the mechanical load. A typical variable speed electric drive contains, in addition, a power electronic converter to produce energy conservation (in pumps, fans etc.) through fast, robust and precise mechanical motion control as required by the application like machine tools, robots, computer - disk drives, transportation means etc. From the beginning of this century, electric drives have been

replacing fluid power actuators and IC machines in both high performance and general purpose applications. The growth of electric drives applications being determined by the current level of technology. High reliability, long lifetime, relatively low maintenance and short startup times of electric drives are in consort with their ecological compatibility: low emission of pollutants. The quality of electric drives has extended by a high efficiency, low no-load losses, high overload capability, fast dynamic response, the possibility of recuperation, and immediate readiness for the full-featured operation after the drive startup. Electric drives are available in a wide range of rated speeds, torques and power, they allow for a continuous speed regulation, reversal capability, and they easily adapt to different environment conditions such as the explosive atmosphere or clean room requirements. Unlike the IC engines, electric motors provide for a ripple-free, continuous torque and secure a smooth drive operation. During the past two decades, the evolution of powerful digital microcontrollers allowed for a full digital control of the electromechanical conversion processes taking place in an electrical drives. The process automation made significant progress in the fifties, thanks to the introduction of Numerical Control (NC). Although not flexible and fully programmable, NC systems replaced relays and mechanical timers common on the factory floor in the first half of the century. As the first reliable and commercially available microcontrollers were made in the sixties, they were advantageously used for the purpose of a flexible control of electric drives in production machines. As from then, the hydraulic and pneumatic actuators gradually disappear and give space to DC and AC electric motors. Although more robust and easier to produce than the DC motors, the AC electric motors were mostly used in constant speed applications and it supplied from the mains until the technological breakthroughs in the early seventies. It took the development of transistorized three phase inverters with digital PWM to provide for a variable frequency supply of induction motors. The invention of IGBT transistors and high speed digital controllers made the variable speed AC drives reliable and acceptable for the drive market. For their increased reliability, low maintenance, and better characteristics, the frequency controlled induction motors gradually replaced DC drives in many of their traditional fields of application. At this level, the reign of DC drives reduced to high speed servo applications. In early eighties, the frequency controlled AC drives are widely accepted, but their prices still level those of DC drives. The cost of an AC drive package has a 30 percent motor plus 70 percent power converter structure, while in the case of a DC drive the motor is worth 70 percent of the package cost. The prices of power- and signal- semiconductors will presumably decline, while the cost of electric motors will remain tied to the copper and iron prices. For that reason, the AC drives have the perspective of decreasing the package cost, evermore cheaper than their DC counterparts. Further technological improvements are likely to make the frequency controlled AC drives the cheapest actuators ever. At present, in an industrialized country the AC

drives substitute DC motors at a pace of 15% per year. More than 20% of the drives are frequency controlled, while the remaining 80% operate at a constant speed. In most of high volume applications of digitally controlled electric motors, microcontroller executes both the drive control functions and the application specific functions such as the handling of the washing, rinsing and drying in the case of modern dishwashers and washing machines. Compact digital controllers emulates the functions traditionally implemented in the analog form and allows the execution of nonlinear and complex functions that could not have been completed by analog circuitry (ANN, nonlinear estimators, spectrum estimation and others). Recently the vector control concept empowered the AC machines to conquer the high performance drives market.

### III. AN OVER OF VIEW AI TECHNIQUES BASED ELECTRICAL DRIVE SYSTEMS

Recently Artificial Intelligence based techniques (i.e. fuzzy logic, neural networks, fuzzy-neural networks, genetic algorithms, etc.) have gained a wide attention in control applications. There are numerous AI applications to electrical machines and drives. The drives are D.C. drives, induction motor drives, synchronous motor drives, switched reluctance motor drives and sensorless drives etc. For most drives, high accuracy is not usually imperative, however, in high performance drive applications, a desirable control performance in both transient and steady states must be provided even when the parameters and load of the motor are varying during the motion. Controllers with fixed parameters cannot provide these requirements unless unrealistically high gains are used. Thus, the conventional constant gain controllers used in the high performance variable speed drives become poor when the uncertainties of the plant exist, such as load disturbance, mechanical parameter variations and unmodeled dynamics in practical applications. Therefore, control strategy of high performance electrical drives must be adaptive and robust. As a result, interest in developing adaptive control methods for electrical drives has increased considerably with in the last two decades and several adaptive control methods based on linear model have developed for induction motor drives. In the past decade, fuzzy logic and neural network control techniques have applied to electrical drives to deal with nonlinearities and uncertainties of the control system. Fuzzy control has the ability of implementing expert human knowledge and experience expressed in the form of linguistic rules. It is easy to understand the structure of the fuzzy controller and to modify the control laws. Hence, fuzzy logic control introduces a good tool to deal with the complicated, nonlinear and ill defined systems, which cannot be described by precise mathematical models. However, fuzzy controllers have difficulties in determining suitable fuzzy control laws and tuning the parameter of the membership functions for system changes. The major advantageous features of neural network are their learning and

generalization capability and fault tolerance. It can adapt itself to changing control environment using the system input and output and it does not require complicated control theories and exact knowledge of the system. However, neural network has some problems in training: the sensitivity of the controlled system, which is difficult to obtain for unknown and nonlinear systems are required and the local minimum of the performance index can be trapped. Besides, it is difficult for the user to decide the structure of the neural network for the desired control. Fuzzy-Neural Network (FNN) approach incorporates the fuzzy logic controller into the neural network structure. Neural network provides connectionist structure and learning abilities to the fuzzy logic controller. In recent years, FNN control has applied to induction motors and used to update the control gain of the sliding mode position controller for an induction motor drive. Fuzzy-neural network controller has augmented with a PI controller, and an adaptive controller.

### IV. SCHEMATIC STRUCTURE OF PROPOSED SENSORLESS SPEED CONTROL OF INDUCTION MOTOR

The schematic of the basic functional blocks used to implement the proposed DTFC of induction motor AC drive with fuzzy speed regulator is shown in Fig.1. A voltage source inverter supplies the motor and instantaneous values of the stator flux and torque are calculated from stator variable by using a closed loop estimator [37] [40]. Stator flux and torque can be controlled directly and independently by properly selecting the inverter switching. The reference Torque is fed to DTFC from a FLC based Fuzzy speed regulator.

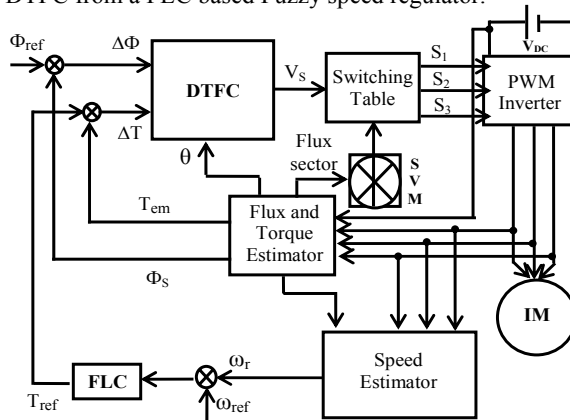

Fig. 1 Direct Torque Fuzzy Control scheme for AC motor drives with Fuzzy speed regulator

#### A. Induction Motor Modal

The induction motor voltage equations in space vector notation can be expressed as follows:

$$\vec{V}_s = R_s \vec{i}_s + \frac{d\vec{\phi}_s}{dt} \quad (1)$$

$$\vec{V}_r = R_r \vec{i}_r + \frac{d\vec{\phi}_r}{dt} - j\omega_r \vec{\phi}_r = 0 \quad (2)$$

The induction motor flux equations in space vector notation can be expressed as follows:

$$\vec{\phi}_s = L_s \vec{i}_s + M \vec{i}_r \quad (3)$$

$$\vec{\phi}_r = L_r \vec{i}_r + M \vec{i}_s \quad (4)$$

The induction motor mechanical equation in space vector notation can be expressed as follows:

$$T_{em} = J \frac{d\omega_r}{dt} + B \omega_r + T_L \quad (5)$$

Where  $J$  is the moment of inertia of the rotor,  $B$  damping coefficient,  $P$  number pair of poles,  $\omega_r$  rotor speed and  $T_L$  is the load torque. Also,

$$T_{em} = \frac{3}{2} P (\vec{i}_s \times j \vec{\phi}_s) \quad (6)$$

Therefore, Substituting (3) and (4) into (5), yields

$$T_{em} = \frac{3PM}{2\sigma L_s L_r} (\vec{\phi}_s \times j \vec{\phi}_r) \quad (7)$$

The dynamic input and out put equations of induction motor are formulated as a time varying state space model in the stator reference frame using the  $\alpha$ - $\beta$  co-ordinate system under the assumptions that linear magnetic circuits, equal mutual inductances and negligible iron losses as follows;

$$\dot{X}(t) = AX(t) + BU(t) \quad (8)$$

$$Y(t) = C X(t) \quad (9)$$

Where  $A$  is the system,  $B$  is the control and  $C$  is the observation matrices. And  $X(t)$  is the state,  $U(t)$  is input and  $Y(t)$  is out put vectors with elements as follows;

$$X(t) = [i_{sd} \quad i_{sq} \quad \phi_{sd} \quad \phi_{sq}]^T \quad (10)$$

$$U(t) = \begin{bmatrix} V_{sd} \\ V_{sq} \end{bmatrix} \quad (11)$$

$$Y(t) = \begin{bmatrix} i_{sd} \\ i_{sq} \end{bmatrix} \quad (12)$$

$$A = \begin{bmatrix} -\delta & 0 & \frac{1-\sigma}{\sigma M \tau_r} & \frac{\omega_r(1-\sigma)}{\sigma M} \\ 0 & -\delta & -\frac{\omega_r(1-\sigma)}{\sigma M} & \frac{\omega_r(1-\sigma)}{\sigma M \tau_r} \\ \frac{M}{\tau_r} & 0 & -\frac{1}{\tau_r} & -\omega \\ 0 & \frac{M}{\tau_r} & \omega_r & -\frac{1}{\tau_r} \end{bmatrix} \quad (13)$$

$$B^T = \begin{bmatrix} \frac{1}{\sigma L_s} & 0 & 0 & 0 \\ 0 & \frac{1}{\sigma L_s} & 0 & 0 \end{bmatrix} \quad (14)$$

$$C = \begin{bmatrix} 1 & 0 & 0 & 0 \\ 0 & 1 & 0 & 0 \end{bmatrix} \quad (15)$$

$$\tau_r = \frac{L_r}{R_r}; \quad \tau_s = \frac{L_s}{R_s}; \quad \sigma = 1 - \frac{M^2}{L_r L_s}; \quad \delta = \left( \frac{1}{\sigma \tau_s} + \frac{1-\sigma}{\sigma \tau_r} \right);$$

Where  $\omega$  represents rotor speed.  $R_s$  and  $R_r$  are the stator and rotor resistances respectively.  $L_s$ ,  $L_r$  are the stator and rotor self-inductances and  $M$  is the mutual inductance respectively.

Where  $\phi_{sd}$ , and  $\phi_{sq}$  are respectively, the stator and rotor flux projections on the (d-q) axes reference frame. Then the electromagnetic torque developed by the induction motor can be expressed as,

$$T_{em} = \frac{3}{2} P (\phi_{sd} i_{sq} - \phi_{sq} i_{sd}) \quad (16)$$

From the above mathematical representation, we can see that the dynamic model of an induction motor is a strongly coupled nonlinear multivariable system. The control problem is to choose ( $V_{sd}$ ,  $V_{sq}$ ) in such a way as to force the motor electrical angular speed  $\omega$  and the rotor flux magnitude  $\phi_s = [\phi_{sd}^2 + \phi_{sq}^2]^{1/2}$  to track given reference values by denoted  $\omega_{ref}$  and  $\phi_{ref}$  respectively. Note that the choice of a reference frame rotating at the same angle and is more suitable for the control problems since in this frame the steady state signals are seems to be constant.

#### B. Stator Flux and Torque Estimation Mechanism

In the conventional DTC scheme, the stator flux is obtained from (18), which is derived from (2.1a) using only the measured stator voltages and currents.

$$\vec{\phi}_s = \int_0^t (\vec{V}_s - R_s \vec{i}_s) dt \quad (17)$$

Using equation (17) the stator flux expression is:

$$\frac{d\vec{\phi}_s}{dt} = \vec{V}_s - R_s \vec{i}_s \quad (18)$$

$$\text{If } R_s i_s \approx 0, \text{ then } \frac{d\vec{\phi}_s}{dt} \approx \vec{V}_s \quad (19)$$

The approximation of the voltage drop in the stator resistance is realistic, excepting at low speeds rang when the ( $R_s i_s$ ) term must be considered. The vector tension applied to the induction motor remains constant during the sampling time period  $T_s$ . Thus we can write, the expression for change in stator flux over the sampling time period  $T_s$  as,

$$\vec{\phi}_s(k+1) \approx \vec{\phi}_s(k) + \vec{V}_s T_s \quad (20)$$

$$\Delta \vec{\phi}_s \approx \vec{\phi}_s(k+1) - \vec{\phi}_s(k) \approx \vec{V}_s T_s \quad (21)$$

If a sequence of null voltage is applied, we note that the variation of the stator flux module is always negative and proportional to voltage drop ( $R_s i_s$ ), as shown by equation (22).

$$\frac{d\vec{\phi}_s}{dt} \approx -R_s \vec{i}_s \quad (22)$$

$$\Delta \vec{\phi}_s \approx \vec{\phi}_s(k+1) - \vec{\phi}_s(k) \approx -R_s \vec{i}_s T_s \quad (23)$$

At average and high speed, the term ( $R_s i_s$ ) can be neglected and therefore the stator flux variation is null for a null voltage vector.

$$\frac{d\bar{\phi}_s}{dt} \approx 0 \quad (24)$$

The components of the currents ( $i_{sd}$ ,  $i_{sq}$ ) and stator voltage ( $V_{sd}$ ,  $V_{sq}$ ) are obtained by the application of the transformation [33] [40] expressed in (25) and (26). The components of the stator flux ( $\phi_{sd}$ ,  $\phi_{sq}$ ) are expressed in (27). The stator flux linkage per phase and the electromagnetic torque estimated are expressed in (28) and (31) respectively.

$$\bar{i}_{sd} = \sqrt{\frac{2}{3}}\bar{i}_A \quad \& \quad \bar{i}_{sq} = \frac{1}{\sqrt{2}}(\bar{i}_B - \bar{i}_C) \quad (25)$$

The voltage source inverter can be modeled as shown in figure 1, where  $S_1$ ,  $S_2$ ,  $S_3$  are the switching states. Eight output voltage vectors  $V_0$  to  $V_7$  {000, 100, 110, 010, 011, 001, 101, 111} are obtained for different switch combinations. Hence,  $V_0$  and  $V_7$  are zero voltage vectors. From the inverter switching we get:

$$\bar{V}_{sd} = \frac{V_{DC}}{3}(2S_1 - S_2 - S_3) \quad \& \quad \bar{V}_{sq} = \frac{V_{DC}}{3}(S_2 - S_3) \quad (26)$$

$$\bar{\phi}_{sd} = \int_0^t (\bar{V}_{sd} - R_s \bar{i}_{sd}) dt \quad \& \quad \bar{\phi}_{sq} = \int_0^t (\bar{V}_{sq} - R_s \bar{i}_{sq}) dt \quad (27)$$

$$\phi_s = \sqrt{\phi_{sd}^2 + \phi_{sq}^2} \quad (28)$$

The stator resistance  $R_s$  can be assumed constant during a large number of converter switching periods  $T_s$ . The voltage vector applied to the induction motor remains also constant over the time period  $T_s$ . Therefore, on resolving (1) leads to:

$$\bar{\phi}_s = \int_0^t (\bar{V}_s - R_s \bar{i}_s) dt \rightarrow \bar{\phi}_s(t) = \bar{\phi}_s(0) + \bar{V}_s T_s \quad (29)$$

In equation (29),  $\phi_s(0)$  stands for the initial stator flux condition. This equation shows that when the term  $R_s I_s$  can be neglected in high speed operating condition of the extremity of stator flux vector  $V_s$ . Also, the instantaneous flux speed is only governed by voltage vector amplitude [20] expressed in (30).

$$\frac{d\bar{\phi}_s}{dt} \approx \bar{V}_s \quad (30)$$

Hence, by selecting adequate voltage vector one can increase or decrease the stator flux amplitude and phase to obtain the required performances with constant flux. The electromagnetic torque is estimated by (31), which is derived from (6).

$$T_{em} = \frac{3}{2} P (\phi_{sd} i_{sq} - \phi_{sq} i_{sd}) \quad (31)$$

## V. DIRECT TORQUE FUZZY CONTROL STRATEGY

This The block diagram of the proposed sensorless speed control scheme for IM with DTFC is shown in figure 1. This

type of control is relatively new and competitive one compare to the rotor flux oriented methods. The objective of DTFC is to maintain the electromagnetic torque and the stator flux module within a defined band of tolerance. This type of control is based on the directly determination of the sequence of control applied to the switches of a tension inverter. This selection is generally based on the use of hysteresis regulators, whose function is to control the state of the system, and to modify the amplitude of the stator flux and the electromagnetic torque.

The stator flux, as given in equation (29), can be approximated as equation (29) over a short time period if the stator resistance is ignored. During one period of sampling  $T_s$ , vector tension applied to the machine remains constant, and thus one can write as in (20) and (21). Therefore to increase the stator flux, we can apply a vector of tension that is co-linear in its direction and vice-versa.

The space vector modulation (SVM) technique is used to approximate the voltage vector by employing the one out of eight possible combinations of vectors generated by 3- $\Phi$  phase voltage source inverter (VSI). In a 3- $\Phi$ , VSI, the switching commands of each limb are complementary. So, for each limb, logic state  $S_i$  (where  $i=1$  to 3) is ON ("1") or OFF ("0") can be defined. As there are three independent limbs, there will be eight different logic states, provides eight different voltages obtained applying the vector transformation described as:

$$V_s = \sqrt{\frac{2}{3}} V_{DC} \left[ S_1 + S_2 e^{j\frac{2\pi}{3}} + S_3 e^{j\frac{4\pi}{3}} \right] \quad (32)$$

Eight switching combinations can be taken according to the above expression (32). The partitions of d-q plane in to two zero voltage vectors and six non-zero voltage vectors are show in Fig.2.

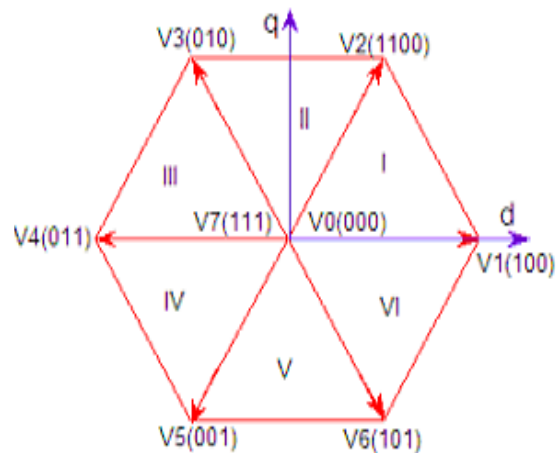

Fig. 2 Partition of the d-q planes in to six angular sectors

The switching pattern of the VSI is selected based on the output of DTFC which is developed based on the knowledge of a pair of hysteresis as variable structure controllers for both

torque and stator flux. In order to adjust the electromagnetic torque and the stator flux linkage, DTFC algorithm selects the stator voltage space vector that produces the desired change [24] [25].

When flux is in sector  $i$ , the vectors  $V_{i+1}$  or  $V_{i-1}$  are selected to increase the amplitude of flux, and  $V_{i+2}$  or  $V_{i-2}$  to decrease it. Hence, the selection of the vector tension depends on the sign of the error of flux, but independent of its amplitude. That implies why the exit of the correction of flux could be a Boolean variable. One adds a bond of hysteresis around zero to avoid ineffective commutations when the error of flux is small. Certainly, with this type of modification, one can easily control and maintain the end of the vector flux in a circular ring. The switching table proposed by Takahashi is as given by Table I.

TABLE I.  
SWITCHING TABLE FOR DTFC BASIS

Sector		I	II	III	IV	V	VI
Flux	Torque						
F=1	T=1	V <sub>2</sub>	V <sub>3</sub>	V <sub>4</sub>	V <sub>5</sub>	V <sub>6</sub>	V <sub>1</sub>
	T=0	V <sub>7</sub>	V <sub>0</sub>	V <sub>7</sub>	V <sub>0</sub>	V <sub>7</sub>	V <sub>0</sub>
	T=-1	V <sub>6</sub>	V <sub>1</sub>	V <sub>2</sub>	V <sub>3</sub>	V <sub>4</sub>	V <sub>5</sub>
F=0	T=1	V <sub>3</sub>	V <sub>4</sub>	V <sub>5</sub>	V <sub>6</sub>	V <sub>1</sub>	V <sub>2</sub>
	T=0	V <sub>0</sub>	V <sub>7</sub>	V <sub>0</sub>	V <sub>7</sub>	V <sub>0</sub>	V <sub>7</sub>
	T=-1	V <sub>5</sub>	V <sub>6</sub>	V <sub>1</sub>	V <sub>2</sub>	V <sub>3</sub>	V <sub>4</sub>

The DTFC of induction motor drive is designed to have three fuzzy input variables and one output control variable to achieve fuzzy logic based DTC of the induction motor. Its functional block diagram is as shown in Fig.3. It requires three input variables, the stator flux error, electro magnetic torque error and angle of stator flux. The output is the voltage space vector [37].

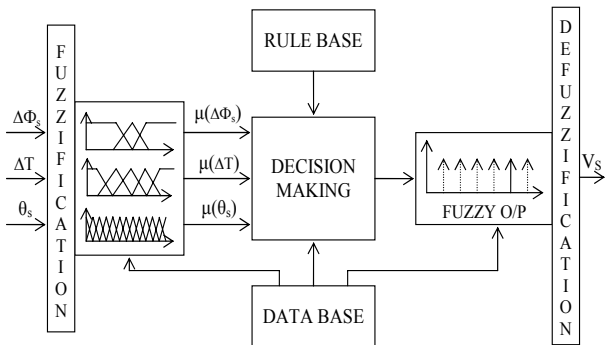

Fig. 3 Proposed DTFC functional block diagram

The internal structure of the DTFC is as shown in Fig.3. The necessary inputs to the decision-making unit blocks are the rule-based units and the data based block units. The fuzzification unit converts the crisp data into linguistic formats. The decision making unit decides in the linguistic

format with the help of logical linguistic rules supplied by the rule base unit and the relevant data supplied by the data base. The output of the decision-making unit is given as input to the de-fuzzification unit and the linguistic format of the signal is converted back into the numeric form of data in the crisp form. The decision-making unit uses the conditional rules of 'IF-THEN-ELSE' [28].

The flux linkage error is given by  $\Delta\Phi = \Phi_{ref} - \Phi_s$ . Where  $\Phi_{ref}$  is the related value of stator flux and  $\Phi_s$  is actual stator flux. Three linguistic values, negative, zero and positive denoted as N, Z and P respectively are used to fuzzify flux linkage error domain. The torque error given by  $\Delta T = T_{ref} - T_{em}$ . Where  $T_{ref}$  is desired torque and  $T_{em}$  is actual torque. Five linguistic values, negative large, negative small zero, positive small and positive large denoted as NL, NS, ZE, PS and PL respectively are used to fuzzify torque error domain. The stator flux linkage angle  $\theta$  is an angle between stator flux  $\phi_s$  and a reference axis is defined as  $\theta_s = \tan^{-1}(\phi_{sd} / \phi_{sq})$ .

Twelve linguistic values,  $\theta_1$  to  $\theta_{12}$  are used to fuzzify the domain of stator flux linkage angle. And the space vector voltage  $V_i$  ( $i=1$  to  $6$ ) is fuzzified using six singleton linguistic values, as  $V_1, V_2, V_3, V_4, V_5$  and  $V_6$  [33][37]. The corresponding inputs and output variables fuzzy function graphs are shown in Fig.4.

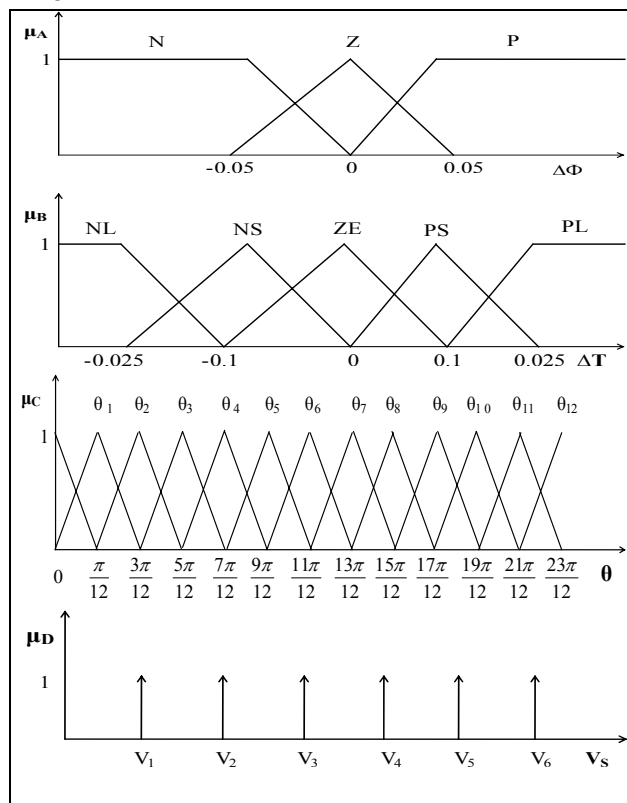

Fig. 4 Inputs and output variables fuzzy functions mapping

Each fuzzy rule can be described using the three input linguistic variables  $\Delta\Phi_s$ ,  $\Delta T$  and  $\theta_s$  and one output linguistic

variable  $V_s$  in the DTFC rule base. The  $i^{th}$  IF-THEN fuzzy rule  $R_i$  of DTFC can be expressed as [37]:

$R_i$ : IF  $\Delta\varphi_s$  is  $A_i$ ,  $\Delta T$  is  $B_i$  and  $\theta_s$  is  $C_i$  THEN  $V_s$  is  $D_i$

Where  $A_i$ ,  $B_i$ ,  $C_i$  and  $D_i$  are fuzzy membership function values obtained from  $\mu_A$ ,  $\mu_B$ ,  $\mu_C$  and  $\mu_D$  membership functions of inputs and output linguistic variables of DTFC respectively for  $i^{th}$  rule [37]. In this paper, Mamdani's fuzzy rule base model is developed to perform the function of proposed DTFC.

### VI. PI-TYPE FUZZY LOGIC CONTROLLER AS A SPEED REGULATOR

The proposed DTFC employs an induction motor model to predict the voltage required to achieve a desired output torque [40]. By using only current and voltage measurements, it is possible to estimate the instantaneous stator flux and output torque. An induction motor model is then used to predict the voltage required to drive the flux and torque to the demanded values within a fixed time period. This calculated voltage is then synthesized using SVM. In AC drive operation, the speed can be controlled indirectly by controlling the torque, for the normal operating region, is directly proportional to the voltage to frequency ratio. So, the speed can be regulated using FLC as a fuzzy speed regulator whose output is the reference torque [39].

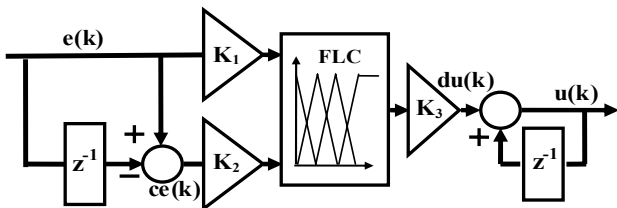

Fig. 5 Basic Structure PI-type Fuzzy Logic Controller

In the SVM voltage source inverter-fed DTFC induction motor drive system, simultaneous control of the torque and the flux linkage was required. So, the reference torque to DTFC is fed from speed loop of the IM drive as shown in Fig.1 which is regulated using PI-type FLC shown in Fig.5. In which  $K_1$ ,  $K_2$  and  $K_3$  are normalization factors. The input linguistic variables speed error  $e(k)$ , change in speed error  $ce(k)$  and output linguistic variable  $du(k)$  membership functions will be divided into seven fuzzy sets with the linguistic values NL (negative large), NM (negative medium), NS (negative small), ZE (zero), PS (positive small), PM (positive medium), PL (positive large) respectively. The fuzzy logic controller is basically an input output static non-linear mapping technique. The PI-type FLC control action can be expressed as,

$$du(t) = K_p e(t) + K_i \int e(t) dt \quad (33)$$

Where  $K_p$  and  $K_i$  are proportional and integral gains. On integrating above equation, we get

$$u(t) = K_p e(t) + K_i \int e(t) dt \quad (34)$$

The discrete form of equation (21) can be expressed as,

$$du(k) = K_p e(k) + K_i ce(k) \quad (35)$$

Equation (35) is a PI-type FLC with non-linear gain factors. The fuzzy associative memory (FAM) of Mamdani rule base model to develop the PI-type FLC as a fuzzy speed regulator [39] which in term replace the PI speed regulator of conventional DTC is given in Table II.

TABLE II.  
FAM OF FLC AS A FUZZY SPEED REGULATOR OF IM

du		CHANGE IN ERROR (ce)						
		NB	NM	NS	ZE	PS	PM	PB
ERROR (e)	NB	NVB	NVB	NVB	NB	NM	NS	ZE
	NM	NVB	NVB	NB	NM	NS	ZE	PS
	NS	NVB	NB	NM	NS	ZE	PS	PM
	ZE	NB	NM	NS	ZE	PS	PM	PB
	PS	NM	NS	ZE	PS	PM	PB	PVB
	PM	NS	ZE	PS	PM	PB	PVB	PVB
	PB	ZE	PS	PM	PB	PVB	PVB	PVB

### VII. ROTOR SPEED ESTIMATION BY MRAS TECHNIQUE

The MRAS technique is used in sensorless IM drives, first time, by Schauder [25]. The MRAS is important as it leads to relatively easy to implement system with high speed of adaptation for a wide range of applications. The basic scheme of the parallel MRAS configuration is given in Fig.6. The scheme consists of two models; reference and adjustable ones and an adaptation mechanism. The block "reference model" represents the actual system having unknown parameter values. The block "adjustable model" has the same structure of the reference one, but with adjustable parameters instead of the unknown ones. The block "adaptation mechanism" estimates the unknown parameter using the error between the reference and the adjustable models and updates the adjustable model with the estimated parameter until satisfactory performance is achieved.

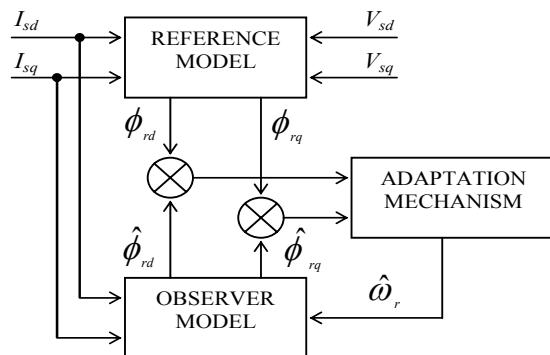

Fig. 6 Structure of MRAS Speed Estimator

A linear state observer for the rotor flux can then be derived by considering the mechanical speed as a constant parameter as its variation is very slow in comparison with the electrical

variables. As the reference model is independent of the rotation speed, it allows for calculating the components of rotor flux from the stator voltage equations.

$$\frac{d\phi_{rd}}{dt} = \frac{1}{a} \left( V_{sd} - R_s i_{sd} - \frac{1}{b} \frac{di_{sd}}{dt} \right) \quad (36)$$

$$\frac{d\phi_{rq}}{dt} = \frac{1}{a} \left( V_{sq} - R_s i_{sq} - \frac{1}{b} \frac{di_{sq}}{dt} \right) \quad (37)$$

Where,

$$a = \frac{M}{L_r} ; \quad b = \frac{1}{\sigma L_s} ; \quad c = \frac{R_r}{L_r}$$

The speed of rotation is used in the observer model to estimate the components of rotor flux.

$$\frac{d\hat{\phi}_{rd}}{dt} = -c\hat{\phi}_{rd} - P\hat{\omega}\hat{\phi}_{rq} + cMi_{sd} \quad (38)$$

$$\frac{d\hat{\phi}_{rq}}{dt} = -c\hat{\phi}_{rq} + P\hat{\omega}\hat{\phi}_{rd} + cMi_{sq} \quad (39)$$

The adaptation mechanism compares the two models and estimates the speed of rotation by an integral proportional regulator. Using Lyapounov stability theory, we can construct a mechanism to adapt the mechanical speed from the asymptotic convergence's condition of the state variables estimation errors.

$$\hat{\omega}_r = K_p (\hat{\phi}_{rd} \phi_{rq} - \phi_{rd} \hat{\phi}_{rq}) + K_i \int (\hat{\phi}_{rd} \phi_{rq} - \phi_{rd} \hat{\phi}_{rq}) dt \quad (40)$$

Where  $K_p$  and  $K_i$  are positive gains.

### VIII. SIMULATION AND RESULTS

To verify the proposed scheme, the simulation has been carried out by using MATALAB SIMULINK. In the simulation performed, certain stator flux and torque references are compared to the values calculated in the driver and errors are sending to the DTFC. The outputs of the flux and torque comparators are used in order to determine the appropriate voltage vector and stator flux space vector by employing DTFC and the actual speed is estimated by means of MRAS.

The digital simulation studies were made by using the SIMULINK software in MATLAB environment for the system described in Fig.1. The speed and torque loops of the drive are designed using fuzzy logic control techniques and same has been simulated. The feedback control algorithms were iterated until best simulation results were obtained. The system dynamic responses obtained by simulation are shown in Fig.6 and Fig.7 for stator currents, torque and speed to conclude the comparative results of sensorless conventional DTC with PI speed regulator and proposed sensorless DTFC with FLC as a fuzzy speed regulator. The fuzzy logic based sensorless DTFC with Fuzzy speed regulator of IM drive presents the very much improved performances to achieve tracking of the desired trajectory. In which the rise time is 0.44 seconds for sensorless DTFC with fuzzy speed regulator and 1.23 seconds for sensorless conventional DTC with PI

type speed regulators respectively. From the simulated speed response of speed shown in Fig.8 of the proposed scheme, the tracking of the speed change is very fast compare to the sensorless conventional DTC scheme simulated results shown in Fig.7. The reason for superior performance is basically it is adaptive in nature and is able to realize different control law for each input state of error and change in error. Also, the Fig.8 shows the ripple in the proposed control scheme for simulated stator currents and the actual torque responses is found to be very much reduced.

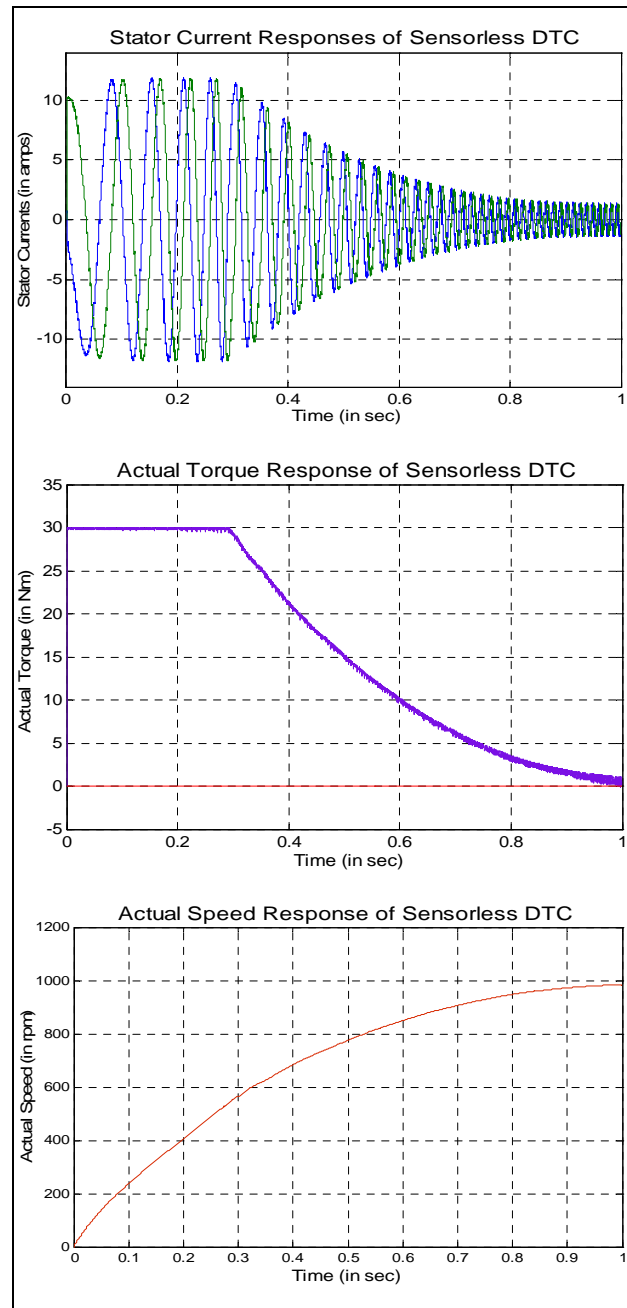

Fig. 7 Sensorless Conventional DTC simulated responses with PI speed regulator



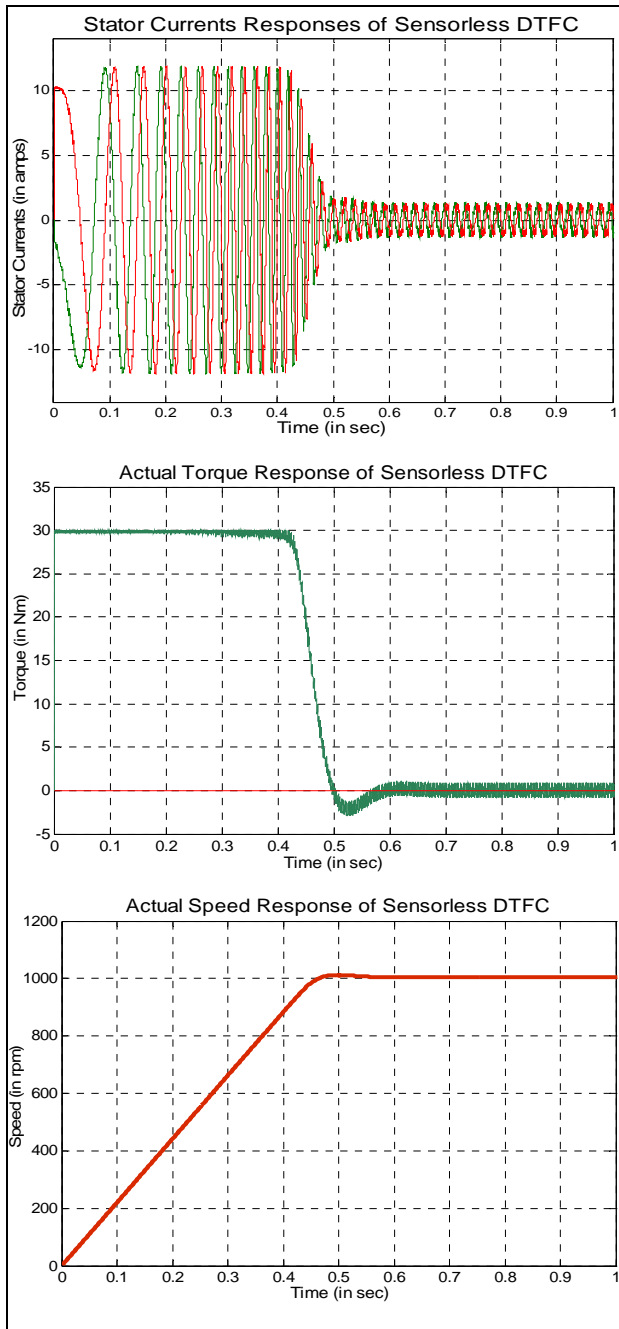

Fig. 8 Proposed Sensorless DTFC simulated responses with Fuzzy speed regulator

## IX. CONCLUSIONS

The paper presents a new approach for sensorless speed control of IM drive system using fuzzy logic technique. In this paper, a fuzzy logic based DTC methodology for IM drive system intended for an efficient control of the torque and flux without changing the motor parameters has been developed. Also, the flux and torque can be directly controlled with the inverter voltage vector using SVM technique. A DTFC is designed in order to satisfy the limits of the flux and torque

and to select the space vector voltage of switching table. A PI type FLC has been designed as fuzzy speed regulator which provides the reference torque to DTFC. And also a MRAS type speed estimator is developed to estimate the rotor speed.

The proposed system has been analyzed, designed and performances were studied extensively by simulation to validate the theoretical concept. The simulation results show that the proposed controller is superior to conventional DTC in robustness and in tracking precision. The sensorless speed control of IM with DTFC and fuzzy speed regulator strategy provides fast dynamic responses with no overshoot and negligible steady-state error. So, it is concluded that it can be applied for the AC servo systems and is reliable in a wide operating speed range.

## REFERENCES

- [1] S. Benaicha, R. Nait-Said, F. Zidani, M-S. Nait-Said, B. Abdelhadi, "A direct torque fuzzy control of SVM inverter-fed Induction Motor drive", *Proc. of the International Journal of Artificial Intelligence and Soft Computing* Vol. 1, Nos. 2-4, pp. 259 – 270, 2009.
- [2] Mei C. G., Panda S. K., Xu J. X., Lim K. W., *Direct Torque Control of Induction Motor-Variable Switching Sectors*. IEEE Int. Conf. Power Electron. and Drive Sys., PEDS'99, Hong Kong, 1999, p. 80-85.
- [3] Lascu C., Boldea I., Blaabjerg F., *A Modified Direct Torque Control for Induction Motor Sensorless Drive*. IEEE Trans. Ind. Applicat., 2000, 36(1), p. 122-130.
- [4] Aller J. M., Restreo J. A., Bueno A., Paga T., Guzman V. M., Giménez M. I., Sensorless Speed Control of the Induction Machine Combining Field Orientation Method and DTC.
- [5] Barut M., Bogosyan S., Gokasan M., *Speed sensorless direct torque control of IMs with rotor resistance estimation*. Int. J. Energy Conv. and Manag., 2005, 46, p. 335-349.
- [6] Sbita L., Ben Hamed M., An MRAS-based full order Luenberger observer for sensorless DRFOC of induction motors. Int. J. ACSE, 2007, 7(1), p. 11-20.
- [7] Cirrincione M., Pucci M., Sensorless direct torque control of an induction motor by a TLS-based MRAS observer with adaptive integration. Automatica, 2005, 41, p. 1843-1854.
- [8] Pedro L. R. S., Aurelio G. C., Vicente F. B., Indirect-Field-Oriented Control of an Asynchronous Generator with Rotor-Resistance Adaptation Based on a Reference Model. 15th Triennial World Congress, IFAC, Barcelona, Spain, 2002.
- [9] Bilal A., Umit O., Aydin E., Mehrded E., *A Comparative Study on Non-Linear State Estimators Applied to Sensorless AC Drives: MRAS and Kalman Filter*. 30 Annual Conf. of the IEEE Ind. Electron. Society. Busan, Korea, 2004.
- [10] Ouhrouche M. A., Estimation of speed, rotor flux and rotor resistance in cage induction motor using the EKF-algorithm. Int. J. Power and Energy Sys., 2002, p. 1-20.
- [11] Messaoudi M., Sbita L., Abdelkrim M. N., *On-line rotor resistance estimation for sensorless indirect vector control of induction motor drives*. IEEE Forth Int. Multi-Conf. on Systems, Signals and Devices SSD'07, El Hammamet, Tunisia, 2007, 2.
- [12] Kyo B. L., Frede B., Reduced-Order Extended Luenberger Observer Based Sensorless Vector Control Driven by Matrix Converter With Nonlinearity Compensation. IEEE Trans. Ind. Electron., 2006, 53(1), p. 66-75.
- [13] Cheng Z. C., Hai P. L., *An Application of Fuzzy-Inference-Based Neural Network in DTC System of Induction Motor*. In Proc. First Int. Conf. on Machine Learning and Cybernetics, Beijing, 2002, p. 354-359.
- [14] Sbita L., Ben Hamed M., *Fuzzy controller and ANN speed estimation for induction motor drives*. IEEE Forth Int. Multi-Conf. on Systems, Signals and Devices SSD'07, El Hammamet, Tunisia, 2007, 2.

- [15] Mir S., Elbuluk M. E., Zinger, D. S., PI and Fuzzy Estimators for Tuning the Stator Resistance in Direct Torque Control of Induction Machines. *IEEE Trans. Power Electron.*, 1998, 13(2), p. 279-287.
- [16] Lascu C., Boldea I., Blaabjerg F., Variable-Structure Direct Torque Control - A Class of Fast and Robust Controllers for Induction Machine Drives. *IEEE Trans. Ind. Electron.*, 2004, 51(4).
- [17] Sang M. K., Woo Y. H., Sung J. K., *Design of a new adaptive sliding mode observer for sensorless induction motor drive*, *Electric. Power Sys. Res.*, 2004, 70, p. 16-22.
- [18] Messaoudi M., Sbita L., Abdelkrim M. N., A robust nonlinear observer for states and parameters estimation and on-line adaptation of rotor time constant in sensorless induction motor drives. *Int. J. Phys. Sci.*, 2007, 2(8), p. 217-225.
- [19] El Hassan I., Westerholt E. V., Roboam X., De Fomel B., Comparison of different state models in Direct Torque Control of induction machines operating without speed sensor. *IEEE*, 2000, p. 1345-1352.
- [20] Huai Y., Melnik R. V. N., Thogersen P. B., *Computational analysis of temperature rise phenomena in electric induction motors*. *Applied Thermal Engineering*, 2003, (23), p. 779-795.
- [21] Nick R. N. I., Abdul H. M. Y., Direct Torque Control of Induction Machines with Constant Switching Frequency and Reduced Torque Ripple. *IEEE Tran. Ind. Electron.*, 2004, 51(4), p. 758-767.
- [22] Faiz J., Sharifian M. B. B., Keyhani A., Proca A. B., *Sensorless Direct Torque Control of Induction Motors Used in Electric Vehicle*. *IEEE Trans. Energy Conv.*, 2003, 18, p. 1-10.
- [23] Kang J. K., Sul S. K., New Direct Torque Control of Induction Motor for Minimum Torque Ripple and Constant Switching Frequency. *IEEE Trans. Ind. Applicat.*, 1999, 35(5), p. 1076-1082.
- [24] José R., Jorge P., César S., Samir K., Hemin M., *A Novel Direct Torque Control Scheme for Induction Machines with Space Vector Modulation*. 35th Annual IEEE Power Electron. Specialists Conf. Aachen, Germany, 2004, p. 1392-1397.
- [25] Schauder C., Adaptive Speed Identification for Vector Control of Induction Motors without Rotational Transducers. *IEEE Trans. Ind. Applicat.*, 1992, 28(5), p. 1054-1062.
- [26] Ben Hamed M., Sbita L.: Speed sensorless indirect stator field oriented control of induction motor based on Luenberger observer, In *Proc. IEEE-ISIE Conf. Montréal, Québec, Canada, 2006*, 3, p. 2473-2478.
- [27] Yager, R. G. "Fuzzy Logics and Artificial Intelligence", *Journal of the Fuzzy Sets and Systems*, Vol. 90, pp. 193-198, 1997.
- [28] Lee, C. C. "Fuzzy Logic in Control System: Fuzzy Logic Controller". *Proc. of the Part I/II, IEEE Trans. Systems Man. Cybernetics*, Vol. 20, pp. 404-435, 1990.
- [29] Takahashi I, Naguchi T. "A new quick-response and high-efficiency control strategy of an induction motor", *Proc. of the IEEE Transactions on Industry Application [ISSN 0093-9994]*, Vol. 22, No. 5, pp. 820-827, 1986.
- [30] Hui-Hui Xiao, Shan Li, Pei-Lin Wan, Ming-Fu Zhao, "Study on Fuzzy Direct Torque Control System", *Proc. of the Fourth International Conference on Machine Learning and Cybernetics*, Beijing, pp: 4-5 August 2002.
- [31] Mamdani, E. H. "Applications of Fuzzy Algorithms for Simple Dynamic Plants", *Proc. of the IEE 121*, pp. 1585 - 1588, 1974.
- [32] TANG, L. et al "A New Direct Torque Control Strategy for Flux and Torque Ripple Reduction for Induction Motors Drive by Space Vector Modulation", *Conf. Rec. IEEE-PESC'2001*, Vol. 2, pp. 1440-1445, 2001.
- [33] R.Toufouti S.Meziiane, H. Benalla, "Direct Torque Control for Induction Motor Using Fuzzy Logic", *Proc. ACSE Journal*, Vol. 6, Issue 2, pp.19 - 26, Jun. 2006.
- [34] Jagadish H Pujar and S.F. Kodad "Speed Control of Induction Motor Using Rough-Fuzzy Controller" *Proc. of the Second International Conference on Cognition and Recognition*, PES College of Engineering, Mandya, Karnataka, April 10<sup>th</sup>-12<sup>th</sup> 2008.
- [35] F. Blaschke "The principle of field orientation as applied to the new TRANSVECTOR closed loop control system for rotating field machines", *Siemens Review XXXIX*, (5), pp:217-220, 1972
- [36] Jagadish H. Pujar, S.F. Kodad "Simulation of Fuzzy Logic Based Direct Torque Controlled Permanent Magnet Synchronous Motor Drive", *Proceedings of the International Conference on Artificial Intelligence-ICAI'09*, Vol. I, pp. 254-257, July 13-16, 2009, Las Vegas Nevada, USA.
- [37] Jagadish H. Pujar, S. F. Kodad "Direct Torque Fuzzy Control of an AC Drive", *IEEE Proc. of the International Conference on Advances in Computing, Control & Telecommunication Technologies-ACT'09*, Trivandrum, India, pp. 275-277, 28-29 Dec. 2009.
- [38] Jagadish H. Pujar, S. F. Kodad "Digital Simulation of Direct Torque Fuzzy Control of PMSM Servo System", *International Journal of Recent Trends in Engineering- IJRTE*, Vol. 2, No. 2, pp. 89-93, Nov 2009.
- [39] Jagadish H. Pujar, S. F. Kodad "Fuzzy Speed Regulator for Induction Motor Direct Torque Control Scheme", *International Journal of Recent Trends in Engineering- IJRTE*, Vol. 3, No. 3, pp. 10-14, May 2010.
- [40] Jagadish H. Pujar, S. F. Kodad "Digital Simulation of Direct Torque Fuzzy Control of IM with Fuzzy Speed Regulator", *International Journal of Recent Trends in Engineering- IJRTE*, Vol. 3, No. 3, pp. 15-19, May 2010.



**Jagadish. H. Pujar** received the M. Tech degree in Power and Energy Systems from NITK Surthkal, Mangalore University in the year 1999. He has got a teaching experience of round 11 years. Currently, he is working as an Asst. Professor in B V B College of Engg. Tech., Hubli, Karnataka, India in the Dept. of EEE and simultaneously he is pursuing Ph.D in EEE Department of the prestigious Jawaharlal Nehru Technological University, Anapatur, Andhra Pradesh, India. His area of interests are neural networks, fuzzy logic, power electronics, power systems, soft computing techniques based systems development.



**Dr. S. F. Kodad** received the B.E. degree in EEE from STJ Institute of Technology, Ranebennur, Karnataka, India from Karnataka University and the M.Tech. degree in Energy Systems Engg. from JNTU, Hyderabad, India in the year 1992. He received his Ph.D. degree in Electrical Engg. from JNTU, Hyderabad, India in the year 2004. He has got a teaching experience of nearly 21 years. Currently, he is working as Director in Krishnamurthy Institute of Technology, Hyderabad, Andhra Pradesh, India. He has published a number of papers in various national & international journals & conferences & done a number of in-house & industry projects. He has also presented a number of guest lectures and various seminars and participated in a number of courses, seminars, workshops, symposiums in the various parts of the country in different institutions and also conducted a few courses. He is also guiding a number of Ph.D students. His area of interests are neural networks, fuzzy logic, power electronics, power systems, artificial intelligence, Matlab, Renewable energy sources, etc.