

# Robust On-Body Communications using Creeping Wave: Methodology and Analysis

M. Ali, K. Masood

**Abstract**—In this paper methodology to exploit creeping wave for body area network BAN communication reliability are described. Creeping wave propagation effects are visualized & analyzed. During this work Dipole, IA antennas various antennas were redesigned using existing designs and their propagation characteristics were verified for optimum performance when used on BANs. These antennas were then applied on body shapes-including rectangular, spherical and cylindrical so that all the effects of actual human body can be taken nearly into account. Parametric simulation scheme was devised so that on Body channel characterization can be visualized at front, curved and back region. In the next phase multiple inputs multiple output MIMO scheme was introduced where virtual antennas were used in order to diminish the effects of antennas on the propagation of waves. Results were, extracted and analyzed at different heights. Finally based on comparative measurement and analysis it was concluded that on body propagation can be exploited to gain spatial diversity.

**Keywords**—BAN, Creeping Wave, MIMO, WIAs.

## I. INTRODUCTION

**B**ODY area networks deal with the communications On and around human body .They can be divided into on-body and off-body networks. On-body networks correspond to communications on the human body. For on-body communications there are two important things to consider: one is the design of antennas and second is the fading characteristics of propagation [1]. The fading of propagation channel around the human body has been studied relevant to specific antenna types, but in all those cases the effects of antennas are inherently included [1]. If we can eliminate the effects of antennas, then we can focus on the propagation only channel characteristics.To understand the propagation-only channel characteristics it is necessary to first understand and visualize the propagation including the effect of antennas and then analyzing the propagation behavior eliminating the effect of antennas. After going through existing work parametric simulation study including the effect of antennas is done. Then final simulation scheme using MIMO is evolved without the effect of antennas.So in this paper the methodology to exploit creeping wave, data collection methods and then analysis based on the graphical information of on-body-channels is given.

## II. THEORETICAL BACKGROUND

On body propagation is combination of several type of propagation waves which includes surface, diffracted and

F. M.Ali was with the LTH (Lund University of Technology), Kiruna, Sweden (phone: 0092-331-5255522; e-mail: aliman8@hotmail.com).

S. K.Masood, is studying in NWPU (NorthWestern Polytechnical University), Xian, China(phone: 0086-18291863843; e-mail: khayyam\_masood@hotmail.com).

creeping waves. Surface waves correspond to LOS (line-of-sight) body surface to body surface propagation) whereas NLOS (Non-Line-of-sight) propagation is achieved through creeping waves. For Wireless BANs geometrical analysis can be used for channel analysis but it has certain restrictions of chosen antenna positions, body postures and off-body environment. [7].We tried to achieve robustness in on-body communications the creeping wave with antenna and propagation effects irrespective of the environment. Creeping wave is any incident wave which is diffracted around the shadowed surface of a smooth convex shaped body. it propagates along the surface and loses energy by tangentially shedding diffracted waves. The propagation behavior is observed around the body in different regions with and without effect of antennas. Using CST simulations are performed and then using MATLAB 3-D analysis is done.

## III. DESIGN AND ANALYSIS

The procedural flow chart for the scheme to be followed is given in Fig.1. After getting necessary knowledge next step is to adopt design approach. To exploit creeping wave characteristics it is necessary to visualize wave propagation behavior around human body. Various antennas and shapes are used in order to correctly estimate the propagation characteristics around human body. Software used is CST simulation software. All the simulations are done at frequency of 2.45 GHz. The body material used is equivalent to that of muscle and human flush with conductivity of 1.81 S/m and relative permittivity of 53.58.

Considering this fact, and to get a better insight into antenna properties, we focus on the variations of E-field around the body. In the process, two methods are used to observe E-field around the body:

- In the first method, we compared the values of the transmission coefficient  $S_{21}$ , i.e. a receive antenna is used to detect the E-field field (Fig 2).
- In the second method, the E-field is perfectly measured without receive antenna(s). From another perspective, there is no receiving antenna(s) to disturb the E-field distribution.

Simulation study is done by evaluating several 3-D body shapes, i.e., spherical, rectangular and cylindrical bodies. Different antennas, including, monopoles, dipoles and wearable integrated antennas (WIAs), are used. Fig.3 shows the monopole antennas moving around spherical body at constant rate and at constant height of 10 mm .The received position is fixed. For all these positions value of  $S_{11}$ parameter (reflection coefficient) and  $S_{21}$  parameter (transmission coefficient) is obtained. The plot in Fig.3 is given for rectangular body where it is obvious that as soon as transmitting antenna reaches close to receiving antenna the

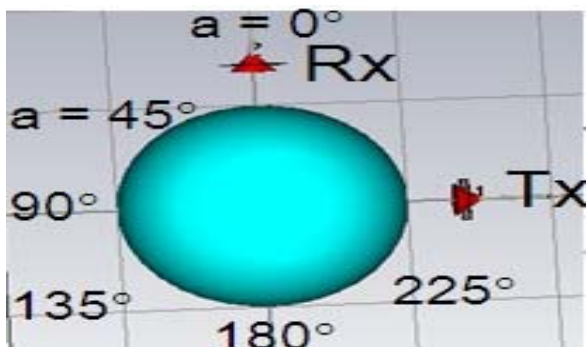

Fig.2 Movement of receive antenna around the body with fixed transmit antenna (at height of 10 mm from the body)

$S_{21}$  value is more where as when it is at 180 degree from transmitting antennas then  $S_{21}$  is minimum. In order to analyze  $S_{21}$  at the back region of the body, the perfect NLOS case (corresponding to the plotted angle of  $90^\circ$  or antenna separation of  $180^\circ$ ) for the cylindrical body is simulated given in Fig.4. The proximity of antennas to the body also affects the matching of the antennas. The resonance of antennas was ensured to be at 2.5 GHz in all cases [4]. As expected, the matching at the center frequency improves as the antennas are moved further away from body (i.e., the influence of the body decreases) [5]. For comparative study, experiment is also performed for spherical body just like the rectangular body. The results are shown in the graph given in Fig.5. To observe the effect of antenna propagation around the body, antennas are also placed at a different distance or "height" from the bodies (i.e. at 20 mm). The height is varied to observe the change of  $S_{21}$  with respect to the distances for the center frequency of 2.5 GHz. Corresponding plot is given in Fig.6. For all the positions including LOS and NLOS, the path gain for the spherical body is consistently better than the rectangular body for antennas at distances of 10 mm and 20 mm as shown in Fig.5 & Fig.6. This result is supported by the presence of very many creeping wave paths on the smooth curved spherical surface. The value of  $S_{21}$  for the spherical body in the NLOS situation (i.e. at larger separation angles

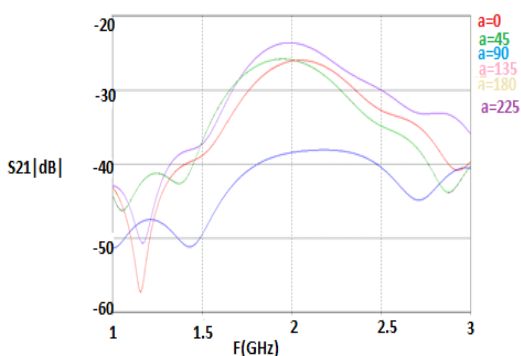

Fig. 3  $S_{21}$  for the rectangular body at different positions of transmit and receive monopole antennas (at the height of 10 mm from the body).

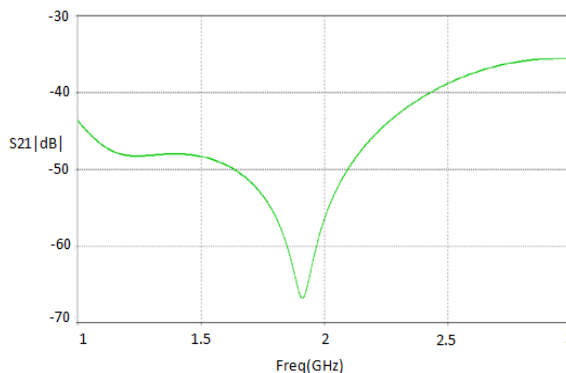

Fig. 4  $S_{21}$  for the cylindrical body when the two antennas are on opposite sides of the body (at the height of 10 mm from the body)

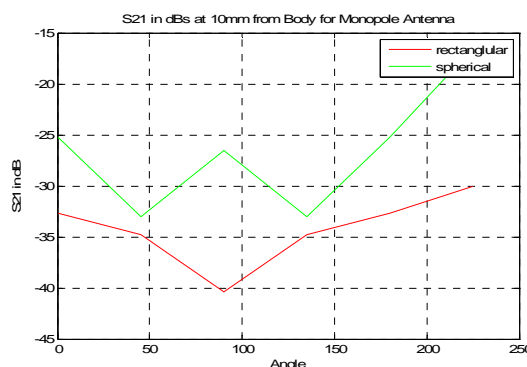

Fig. 5 Comparison of  $S_{21}$  for the spherical and rectangular bodies at the height of 10 mm.

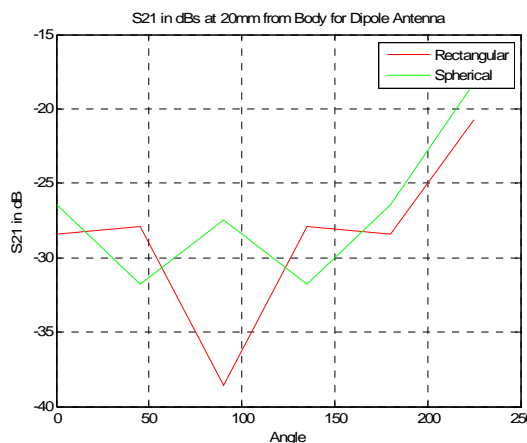

Fig. 6 Comparison of  $S_{21}$  for the spherical and rectangular bodies at the height of 20 mm.

between the antennas of between  $135^\circ$  and  $225^\circ$ , or equivalently between  $45^\circ$  and  $135^\circ$  on the plots) is significantly larger than that for the rectangular body. The  $S_{21}$  parameter for the spherical body is approximately 12-14dB larger than that of the rectangular body, when the antennas are on the opposite sides of the body at the angle of  $90^\circ$  in Fig.5 and Fig.6. The decline in the  $S_{21}$  values for the spherical body for the adjacent positions is sharper than those of the  $S_{21}$

values calculated for the adjacent positions of the rectangular body for both antennas heights of 10mm and 20mm from the body. By changing the antenna distance from the body, the  $S_{21}$  parameters for the rectangular body is almost the same, but the values of  $S_{21}$  for the spherical body experience a downward shift with the increase in distance between the body and the antenna. For the spherical body, the value of  $S_{21}$  for perfect non NLOS (at the angle of  $90^\circ$ ) is greater than that of rectangular and cylindrical body (at the height of 10 mm). The lowest value of  $S_{21}$  is

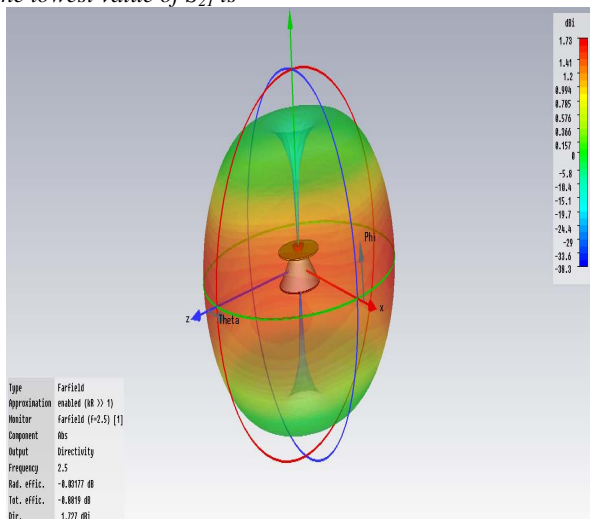

Fig. 7 WIA antennas showing field variation

Observed for the rectangular body, which is 14 dB less than spherical body.  $S_{21}$  value is highly dependent on *both* the body geometry and the type of antennas. E-field variation for WIA shown in Fig 7. WIA configuration on cylindrical body to extract E-field is shown in Fig 8. This antenna gives maximum radiation tangential to the surface and the polarization of the E-field is normal to the body surface. Thus, WIA favors the propagation of creeping waves. Its structure is such that the loading plate is near to the surface, which decreases the direct coupling between the body surface and the antenna element. This leads to smaller variations in impedance with different antenna-body separation distances and boosts on-body communication by minimizing body tissue losses [4].

Simulation results confirm that on-body propagation is best supported by smooth curved surface, as opposed to sharp edges. For bodies with smooth curved surface, the height of the antenna from the body surface is a significant factor influencing the path gain (a loss of 2-3 dB is observed when monopole antennas are elevated from the height of 10 mm to 20 mm). The polarization of the antenna should be normal to the body surface, in order to take advantage of creeping wave propagation. In fact, a loss of up to 20dB was observed when the polarization of the antenna is at a tangential orientation to the body surface, instead of the normal orientation.

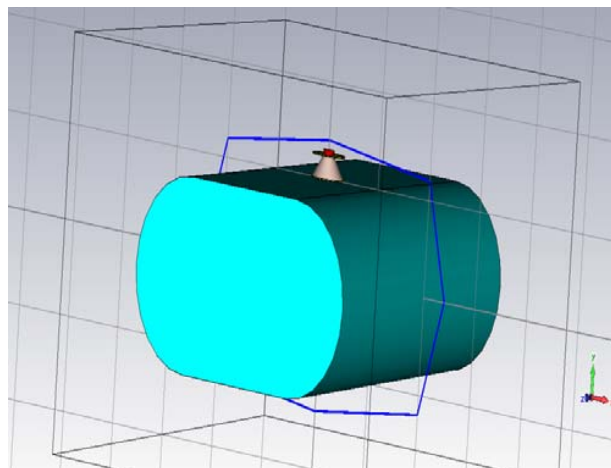

Fig. 8 E-Field calculation around Cylindrical shape

After taking into account the simulations and analysis, it was observed that antennas perform differently depending on the geometry of the body [4]. The antennas design also affects the propagation of E-field around the body. Although the path gain ( $S_{21}$ ) and the E-field give us an overview of the E-field variation, the characteristics of the antennas are inherently included in this analysis. Therefore, the hertzian dipoles are used, in an attempt to decouple the antenna characteristics from the propagation characteristics. In the next part onwards, we will focus on the cylindrical body, since it more closely resembles the shape of human body (or torso).

#### IV. IMPROVISATION AND DEALING WITH PARAMETRIC ANTENNAS

After gaining the necessary insights, we designed and carried out a parametric simulation study (in CST), in which a setup of four transmit antenna positions and three antenna orientations was used. (See Fig 9). Four positions were designed on the front portion (upper side) of the body. The positions were maintained at spacing of  $\lambda/2$  in order to avoid the effect of antennas on each other. The propagation behavior was visualized and analyzed around the body in three different regions: Front, curved and back. Where front portion was one where we placed the antennas, the curved portion was along curved region of the body and back region was the one at 180 degree from front side antennas. The propagation characteristics were studied in all these regions individually. Visualization and analysis of fading characteristics were done for all four positions individually as shown in Fig. 10. The analysis was done by putting antennas in x, y and z orientations respectively and for various heights from the body. The visualization of the electric field around the body shows that when both the transmit and receive antennas are in line-of-sight (LOS) or semi-LOS, the field decays at an exponential rate with separation distance. In non-LOS (NLOS) situations, standing wave patterns were observed in the received fields (see fig 10C). The fading of the NLOS conditions was determined to be log-normally distributed, which agrees with existing studies [5].

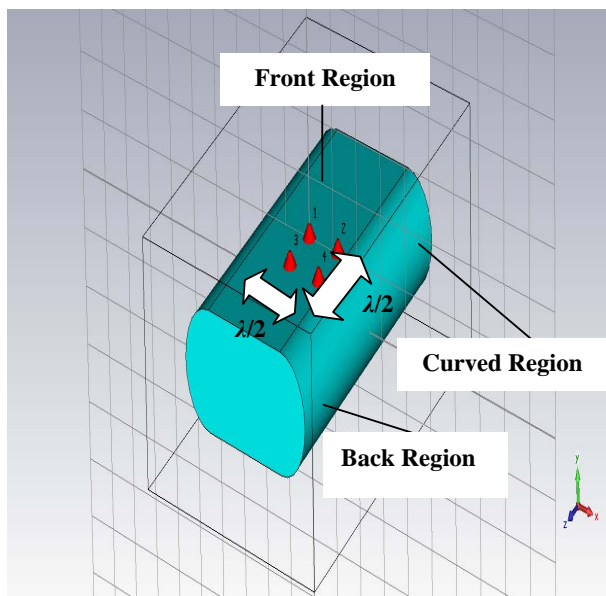

Fig. 9 Different positions of the transmit antennas in the y orientation

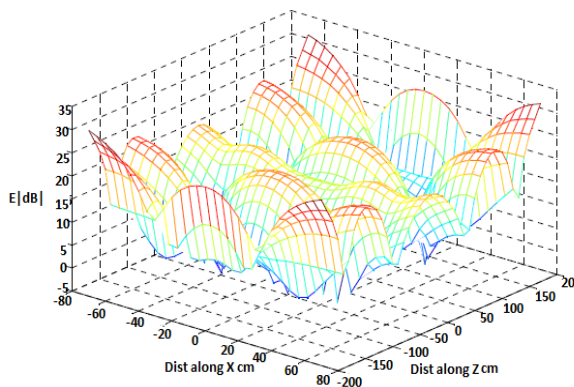

Fig.10(C) Back Region

Fig. 10 3-D view of E-field propagation in the (a) front, (b) curved, and (c) back regions of the body for transmit antenna at Position 1.

Electric field maximum strength is obtained at transmit position 1 of antenna as given in Fig.10A. Before this position electric field is at much reduced level and as we move from transmit position 1 to the edge on front side electric field strength is getting reduced as shown in Fig 10A). So almost uniform distribution of E-field is present on front side. This E-field distribution is continued on the curved region as shown in Fig10B). As obvious from the fig that E-field strength is higher on upper side of curved region and it starts reducing as we move from upper side of curved region to lower side of curved region. At the end of curved region we can see strong variations in E-field as now we are almost at the back side of cylindrical body. E-field distribution continues from this point onwards at the back side of body as given in Fig 10C). The maximum interference region is obtained at the back side of simulated human body [7] as shown in see Fig 10C). This indicates that the fading characteristics in NLOS are favorable for robust on-body communications, even with the absence of scatterers in the surrounding environment [3]-[4].

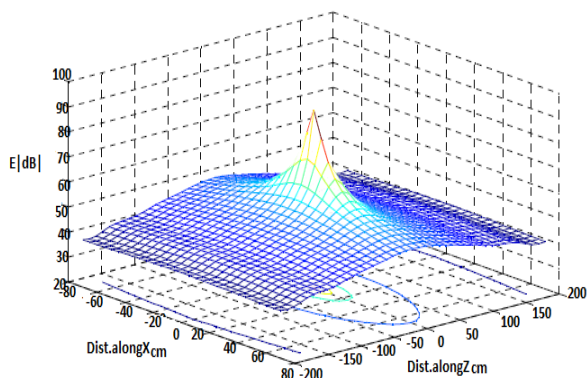

Fig. 10(a) Front Region

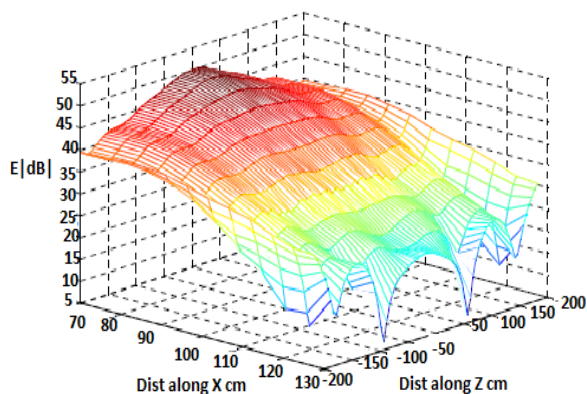

Fig. 10(b) curved region

### V. CONCLUSION

The exploitation of creeping wave for robust communications is such a powerful idea which can boost reliability in on-body communications as clearly indicated in various channel visualizations as shown and discussed in this paper. After using different antennas for the purpose it is concluded that on-body propagation can be increased by using modified antennas. Same benefit can be achieved by using cheaper and simple antenna like dipole and in this case we will need to exploit the creeping wave travelling Normal to the surface of the human body. Capacity calculations can be made and based on the results MIMO scheme can be used to increase the robustness based on spatial diversity concept as indicated by various fading dips especially on the back side of the body.

## REFERENCES

- [1] J. Takada, T. Aoyagi, K. Takizawa, N. Katayama, T. Kobayashi, K.Y. Yazdandoost, H. B. Li, and R. Kohno, "Static propagation and channel models in body area," in *COST2100 TD(08) 639*, Lille, France, Oct. 6-8, 2008.
- [2] L. Liu, P. De Doncker, and C. Oestges, "Fading correlation measurement and modeling on the front and back side of humanbody," in *COST2100 TD(08) 642*, Lille, France, Oct. 6-8, 2008.
- [3] A. Fort, C. Desset, P. Wambacq and L.V. Biesen, "Indoor body area channel model for narrowband communications," *IET Microw. Antennas Propagat.*, vol. 1, no. 6, pp. 1197-1203, Dec. 2007.
- [4] P.S.Hall, Y. Hao, V. I. Nechayev, A.Alomain, C. C.Constantinou, C.Parini, M. R. Kamarudin, T. Z. Salim, D. T. M. Heel, R.Dubrovka, A. S. Owadall, W. Song, A. Serra, P.Nepa, M. Gallo, and M. Bozzetti, "Antennas and propagation for on-body communication systems," *IEEE Antennas Propagat. Mag.*, vol. 49, no. 3, pp. 41-58, Jun. 2007.
- [5] I. Khan, P. S. Hall, Y. I. Nechayev, L. Akhoondzadeh-asl, "Antenna Technology (iWAT)" International Workshop, 2010.
- [6] I. Khan, Hall, P.S. Hall, "Antennas and Propagation" *IEEE Transactions*. vol.58, Issue. 1, pp.195 – 202, 2010.
- [7] J.Ryckert, P.DeDonckder, R.Meys,A.de LE Hoye and S.Domay, "Channel model for wireless communication around human body," *Electron..Lett.*, vol.40, no.9, Apr.29,2004.

**M.Ali** . Mr Muhammad Ali was born in Abbottabad , Pakistan in 1980.He completed his Bachelors of Engineering degree in Electrical with Honors from University of Peshawar Pakistan. He has completed his MS degree in wireless communications from LTH(Sweden).He has served in Public service organization in Pakistan from 2004-2007.During his MS he has also served in LTH(Teacher Assistant) wih Prof.Ulf Korner.Mr. Muhammad Ali is currently working in Pakistan and is in involved in remote research work in collaboration with Professor Timo Hamalainen of Finland.

**K. Masood** . (Islamabad, Pakistan, DOB 21-10-1985), was born in Islamabad, Pakistan on 1985. He completed his bachelor's in engineering in aerospace from Institute of Space Technology, Islamabad, Pakistan. He is currently during his Master's in Aeronautical Engineering from NorthWestern Polytechnical University, Xian, P.R. China. He has served four years in R&D organization in Pakistan and published two international papers. He has supervised two pairs of students in their bachelors final year project and has represented MIHE university, England on various forums. He has also taught A levels and O levels student. Currently his main focus is on his Masters degree.