

# Realization of Electronically Tunable Current-mode First-order Allpass Filter and Its Application

Supayotin Na Songkla, and Winai Jaikla

**Abstract**—This article presents a resistorless current-mode first-order allpass filter based on second generation current controlled current conveyors (CCCII). The features of the circuit are that: the pole frequency can be electronically controlled via the input bias current: the circuit description is very simple, consisting of 2 CCCIIs and single grounded capacitor, without any external resistors and component matching requirements. Consequently, the proposed circuit is very appropriate to further develop into an integrated circuit. Low input and high output impedances of the proposed configuration enable the circuit to be cascaded in current-mode without additional current buffers. The PSpice simulation results are depicted. The given results agree well with the theoretical anticipation. The application example as a current-mode quadrature oscillator is included.

**Keywords**—First-order allpass filter; current-mode; CCCII.

## I. INTRODUCTION

THE current-mode circuits have been receiving considerable attention due to their potential advantages such as inherently wide bandwidth, higher slew-rate, greater linearity, wider dynamic range, simple circuitry and low power consumption [1]. An all-pass filter or phase shifter is one of the most important building blocks of many analog signal processing applications and therefore has received much attention. It is frequently used for introducing a frequency dependent delay while keeping the amplitude of the input signal constant over the desired frequency range. Other type of the active circuits such as oscillators and high-Q band-pass filters are also realized by using all-pass filters [2-6]. The literature surveys show that the first-order all-pass filter circuit using different high-performance active building blocks such as, current conveyors (CCII) [4-5, 7-12], OTAs [13], current controlled current conveyors (CCCII) [14-16, 29], differential voltage current conveyor (DVCC) [17], differential difference current conveyors (DDCCs) [18-19], current differencing buffered amplifier (CDBA) [20] and operational transresistance amplifiers (OTRAs) [21-23], have been reported. Unfortunately, these reported circuits suffer from one or more of the following weaknesses: excessive use of the active and/or passive elements [4-5, 7-23], lack of electronic adjustability [4-5, 7-12, 17-19, 21-23]. The CCII is a reported

active component, especially suitable for a class of analog signal processing [24]. The fact that the device can operate in both current and voltage-modes, provides flexibility and enables a variety of circuit designs. In addition, it can offer advantageous features such as high-slew rate, higher speed, wide bandwidth and simple implementation [24-25]. However, the CCII can not control the parasitic resistance at X ( $R_x$ ) port so when it is used in some circuits, it must unavoidably require some external passive components, especially the resistors. This makes it not appropriate for IC implementation due to occupying more chip area, high power dissipation and without electronic controllability. On the other hand, the introduced second-generation current-controlled conveyor (CCCII) [26] has the advantage of electronic adjustability over the CCII. Also, the use of dual-output current conveyors is found to be useful in the derivation of current-mode single input three output filters using a reduced number of active components [27-28].

The aim of this paper is to propose a current-mode first-order all-pass filter, emphasizing on the use of the CCCII. The features of the proposed circuit are that: the angle pole frequency can be electronically controlled: the circuit description is very simple, it employs 2 CCCIIs and single grounded capacitor as passive component, which is suitable for fabricating in monolithic chip. The performances of the proposed circuit are illustrated by PSpice simulations, they show good agreement with the calculation. The application example of the proposed all-pass filter as a quadrature oscillator is included.

## II. THEORY AND PRINCIPLE

### A. Basic Concept of CCCII

Since the proposed circuit is based on the CCCII, a brief review of CCCII is given in this section. The characteristics of the ideal CCCII are represented by the following hybrid matrix:

$$\begin{bmatrix} I_Y \\ V_X \\ I_Z \end{bmatrix} = \begin{bmatrix} 0 & 0 & 0 \\ 1 & R_x & 0 \\ 0 & \pm 1 & 0 \end{bmatrix} \begin{bmatrix} V_Y \\ I_X \\ V_Z \end{bmatrix}. \quad (1)$$

If the CCCII is realized using CMOS technology,  $R_x$  can be respectively written as

S.N. Songkla is with the Department of Electronic Technology, Faculty of Industrial Technology, Suan Sunandha Rajabhat University, Bangkok, 10300, Thailand (e-mail: n\_songkla@hotmail.com).

W. Jaikla is with the Department of Engineering Education, Faculty of Industrial Education, King Mongkut's Institute of Technology Ladkrabang, Bangkok, 10520, Thailand (e-mail: winai.ja@hotmail.com)

$$R_x = \sqrt{\frac{1}{kI_B}}; k = 8\mu_n C_{ox} \left(\frac{W}{L}\right)_{10-11} = 8\mu_p C_{ox} \left(\frac{W}{L}\right)_{12-13}. \quad (2)$$

Here  $k$  is the physical transconductance parameter of the MOS transistor.  $I_B$  is the bias current used to control the intrinsic resistance at  $x$  port. In general, CCCII can contain an arbitrary number of  $z$  terminals; provide both directions of currents  $I_z$ . As an example, the symbol and the equivalent circuit of the CCCII with a pair of  $z^+$  and  $z^-$  terminals are illustrated in Fig. 1(a) and (b), respectively. The internal construction of CMOS CCCII is shown in Fig. 2.

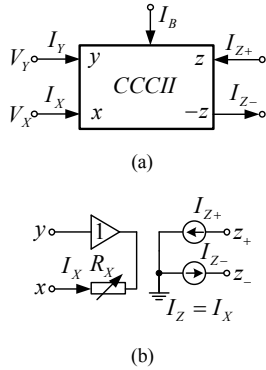

Fig. 1 CCCII (a) Symbol (b) Equivalent circuit

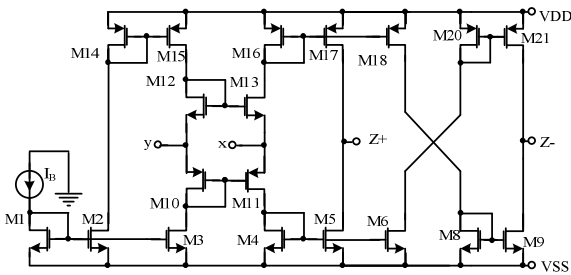

Fig. 2 Schematic of the CMOS CCCII

### B. Proposed current-mode first-order allpass filter

The proposed current-mode first-order allpass filter is illustrated in Fig. 2. It consists of 2 CCCIIs and 1 grounded capacitor. The number of component of the proposed circuit is equal to circuit in Ref. [29]. But the second CCCII in proposed circuit want only 2 terminals  $z$ . It should be noted that to achieve low input impedance of the filter, the first CCCII should has low impedance ( $R_{x1} \cong 0$ ) by setting value of  $I_{B1}$  as high as possible. Considering the circuit in Fig. 2 and using CCCII properties in section II.A, the current transfer function can be rewritten to be

$$\frac{I_o}{I_{in}} = -\frac{1 - sCR_{x2}}{1 + sCR_{x2}}. \quad (3)$$

From Eq. (3), the current gain of the proposed circuit is unity and it also has the phase response as

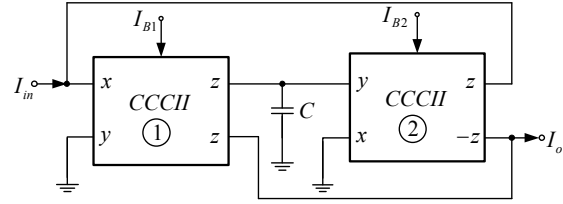

Fig. 3 Proposed current-mode first-order allpass filter

$$\angle H(\omega_p) = \phi(\omega_p) = 180 - 2 \tan^{-1}(\omega_p CR_{x2}). \quad (4)$$

If  $R_{x2} = \sqrt{1/k_2 I_{B2}}$ , the phase response can be re-expressed to be

$$\angle H(\omega_p) = \phi(\omega_p) = 180 - 2 \tan^{-1}(\omega_p C / \sqrt{k_2 I_{B2}}). \quad (5)$$

It can be seen in (5) that the circuit gives a phase shift from  $0$ -( $-180^\circ$ ). Moreover, the angle pole frequency can be electronically controlled by  $I_{B2}$ . The  $\omega_p$  sensitivities of the filter can be written to be

$$S_C^{\omega_p} = -1; S_{I_{B2}}^{\omega_p} = S_{k_2}^{\omega_p} = \frac{1}{2}. \quad (6)$$

Therefore, all of active and passive sensitivities are no more than unity in magnitude.

### III. RESULTS OF COMPUTER SIMULATION

The working of the proposed circuit has been verified using PSpice simulation program. The PMOS and NMOS transistors have been simulated by respectively using the parameters of a  $0.25\mu\text{m}$  TSMC CMOS technology [30]. The aspect ratios of PMOS and NMOS transistor are listed in Table 1. Fig. 2 depicts schematic description of the CCCII used in the simulations. The circuit was biased with  $\pm 1.25\text{V}$  supply voltages,  $C=0.1\text{nF}$ ,  $I_{B1}=300\mu\text{A}$  and  $I_{B2}=50\mu\text{A}$ . Simulated gain and phase responses of the filter are given in Fig. 4. It can be found that the simulated gain and phase responses are slightly deviated from ideal responses due to the error terms as expressed in Eqs. (9) and (10).

TABLE I  
DIMENSIONS OF THE TRANSISTORS

Transistor	W ( $\mu\text{m}$ )	L ( $\mu\text{m}$ )
M1-M9	5	0.5
M10-M11	16	0.25
M12-M13	8	0.25
M14-M16, M18-21	15	0.5
M17	15.1	0.5

Phase response for different  $I_{B2}$  is shown in Fig. 5. This result confirms that the angle pole frequency can be electronically controlled by setting  $I_{B2}$  as shown in Eq. (5). The time-domain response of the proposed filter is shown in Fig. 6. A sine wave of  $20\mu\text{A}$  amplitude and  $2\text{MHz}$  is applied as the input to the filter and the output is  $90^\circ$  phase-shifted.

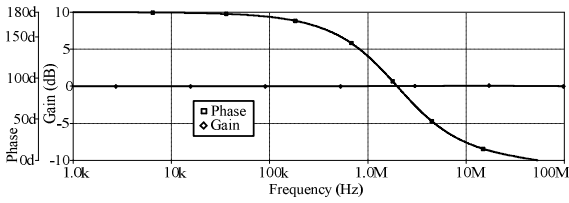

Fig. 4 Gain and phase responses of the proposed allpass filter

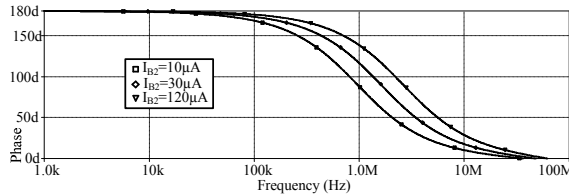

Fig. 5 Simulated phase responses of the proposed allpass filter when  $I_{B2}$  is varied

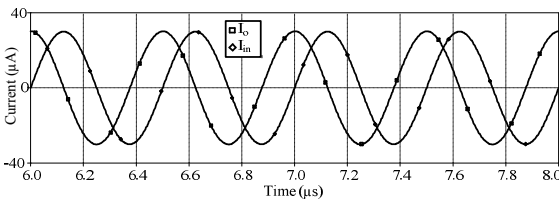

Fig. 6 Filter response to a 2MHz sinusoidal input signal

IV. APPLICATION EXAMPLE AS QUADRATURE OSCILLATOR

To show an application of the proposed allpass filter, a quadrature oscillator is synthesized by cascading an allpass filter and an inverting lossless integrator employing the CCCII, as shown in Fig. 7. The circuit description of current-mode inverting lossless integrator is shown in Fig. 8. Considering the circuit in Fig. 8 and using CCCII properties, the current transfer function is written as

$$\frac{I_o}{I_{in}} = -\frac{1}{sR_{x3}C_2} \tag{11}$$

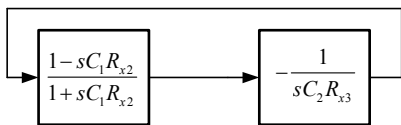

Fig. 7 Block diagram for quadrature oscillator

From the block diagram in Fig. 7, the following characteristic equation can be obtained

$$s^2 + \left( \frac{1}{R_{x2}C_1} - \frac{1}{R_{x3}C_2} \right) s + \frac{1}{C_1C_2R_{x2}R_{x3}} = 0 \tag{12}$$

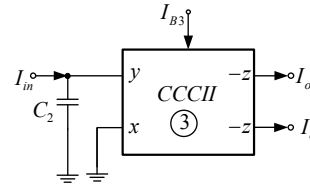

Fig. 8 Current-mode inverting lossless integrator based on CCCII

From Eq. (12), it can obviously be seen that the system can be set as an oscillator if

$$\frac{C_2}{C_1} = \frac{R_{x2}}{R_{x3}} \tag{13}$$

Eq. (13) is called the condition of oscillation, this is achieved by setting

$$C_2 = C_1 \text{ and } R_{x3} = R_{x2} \tag{14}$$

The oscillation frequency of this system can be obtained to be

$$\omega_{osc} = \sqrt{\frac{1}{C_1C_2R_{x2}R_{x3}}} \tag{15}$$

It can be found that both oscillation condition and frequency can be electronically controlled. The circuit description of the quadrature oscillator is shown in Fig. 9.

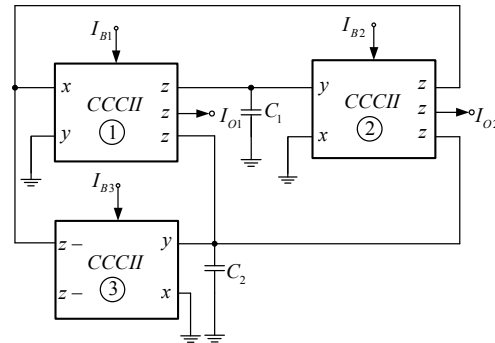

Fig. 9 Quadrature oscillator based on CCCII

The confirmed performances of the oscillator can be seen in Fig. 10 and 11, showing the responses of the oscillator, the bias currents  $I_{B1}$ ,  $I_{B2}$  and  $I_{B3}$  are respectively set to  $300\mu A$ ,  $100\mu A$  and  $102\mu A$ ,  $C_1=C_2=100pF$ . This yields oscillation frequency of 2.5MHz. The total harmonic distortion (THD) is about 0.751%.

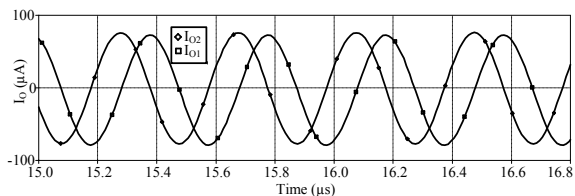

Fig. 10 The simulation result of current waveforms of circuit in Fig. 9

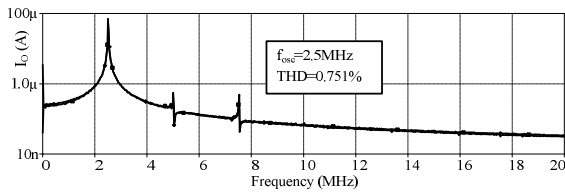

Fig. 11 The output spectrum of the oscillator

## V. CONCLUSIONS

An electronically tunable current-mode first-order allpass filter has been introduced via this paper. The proposed configuration is very simple and can be electronically controlled. It consists of 2 CCCIs and single capacitor. So it is easy to fabricate in IC form to use in battery-powered or portable electronic equipments such as wireless communication devices. The PSpice simulation results were depicted, and agree well with the theoretical anticipation. The application example as the quadrature oscillator is included. It shows good usability of the proposed all-pass filter.

## REFERENCES

- [1] C. Toumazou, F. J. Lidgley and D. G. Haigh, *Analogue IC design: the current-mode approach*, Peter Peregrinus, London, 1990.
- [2] R. Schauman and E. Valkenburg, *Design of analog filters*, Oxford University Press, New York, 2001.
- [3] T. C. Donald, T. C. David, and R.G. Jason, "A high frequency integrable band-pass filter configuration," *IEEE Transactions on Circuits and Systems*. Vol. 44, pp. 856-860, 1997.
- [4] O. Cicekoglul, H. H. Kuntman, and S. Berk, "Single CCII+ based all-pass filters," *Int. J. of Electronics*. Vol. 86, pp. 947-959, 1999.
- [5] M. Higashimura, and Y. Fukai, "Realization of all-pass and notch filters using a single current conveyor," *Int. J. of Electronics*. Vol. 65, pp. 823-828, 1988.
- [6] A. Toker, S. Ozoguz, O. Cicekoglul, and C. Acar, "Current mode all-pass filters using current differencing buffered amplifier and new high-Q band-pass filter configuration," *IEEE Transaction on Circuits and Systems-II*. Vol. 47, pp. 949-954, 2000.
- [7] O. Cicekoglul, and H. H. Kuntman, "CCII+ based first order allpass filters with all grounded passive elements," *Proceeding of MELECON 1998*. Vol. 1, pp. 608-612, 1998.
- [8] K. Pal, and Rana, S. 2004. "Some new first-order all-pass realizations using CCII," *Active and Passive Electronic Components*. Vol. 27, pp. 91-94, 2004.
- [9] A. M. Soliman, "Generation of current conveyor-based all-pass filters from op amp-Based circuits," *IEEE Transactions on Circuits and Systems-II*. Vol. 44, pp. 324-330, 1997.
- [10] J. W. Horng, "Current conveyors based allpass filters and quadrature oscillators employing grounded capacitors and resistors," *Computers & Electrical Engineering*. Vol. 31, pp. 81-92, 2005.
- [11] O. Cicekoglul, H. Kuntman, and S. Berk, "All-pass filters using a single current conveyor," *Int. J. of Electronics*. Vol. 86, pp. 947-955, 1999.
- [12] M. A. Ibrahim, H. Kuntman, S. Ozcan, O. Suvak, and O. Cicekoglul, "New first-order inverting-type second-generation current conveyor-based all-pass sections including canonical forms," *Electrical Engineering*. Vol. 86, pp. 299-301, 2004.
- [13] A. Ü. Keskin, K. Pal, and E. Hancioglu, "Resistorless first-order all-pass filter with electronic tuning," *Int. J. of Electronics and Communications (AEU)*. Vol. 62, pp. 304-306, 2006.
- [14] P. Kumar, A. Ü. Keskin, and K. Pal, "Wide-band resistorless all-pass sections with single element tuning," *Int. J. of Electronics*. Vol. 94, pp. 597-604, 2007.
- [15] A. Toker, E. O. Gune, and S. Ozoguz, "New high-Q band-pass filter configuration using current controlled current conveyor based all-pass filters," *Proceeding of ICECS 2001*. Vol. 1, pp. 165-168, 2001.
- [16] S. Minaei, and O. Cicekoglul, "A Resistorless realization of the first-order all-pass filter," *Int. J. of Electronics*. Vol. 93, pp. 177-183, 2006.
- [17] M. A. Ibrahim, S. Minaei, and H. A. Kuntman, "DVCC based differential-mode all-pass and notch filters with high CMRR," *Int. J. of Electronics*. Vol. 93, pp. 231-240, 2003.
- [18] M. A. Ibrahim, H. Kuntman, and O. Çiçekođlu, "First-order all-pass filter canonical in the number of resistors and capacitors employing a single DDCC," *Circuits, Systems, and Signal Processing*. Vol. 22, 525-536, 2003.
- [19] J. W. Horng, C.-L. Hou, C.-M. Chang, Y.-T. Lin, I.-C. Shiu, and W.Y. Chiu, "First-order all-pass filter and sinusoidal oscillators using DDCCs," *Int. J. of Electronics*. Vol. 93, pp. 457-466, 2006.
- [20] S. Maheshwari, "Voltage-mode all-pass filters including minimum component count circuits," *Active and Passive Electronic Components*. 2006.
- [21] S. Kilinc, and U. Cam, "Realization of allpass filters using operational transresistance amplifier (OTRA)," *Proceeding of the IEEE 12th Signal Processing and Communications Applications Conference*. Vol. 1, pp. 133-136, 2004.
- [22] S. Kilinc, and U. Cam, "Operational transresistance amplifier based first-order allpass filter with an application example," *Proceeding of the MWSCAS '04*. Vol. 1, pp. 65-68, 2004.
- [23] C. Cakir, U. Cam, and O. Cicekoglul, "Novel allpass filter configuration employing single OTRA," *IEEE Transactions on Circuits and Systems-II*. Vol. 52, pp. 122-125, 2005.
- [24] K. C. Smith, and A. Sedra, "The current conveyor-a new circuit building block," *IEEE Proc*. Vol. 56, pp. 1368-1369, 1968.
- [25] A. Sedra, and K. C. Smith, "A second-generation current conveyor and its applications," *IEEE Trans. Circuit Theory*. Vol. 17, pp. 132-134, 1970.
- [26] A. Fabre, O. Saaïd, F. Wiest, and C. Boucheron, "Current controllable bandpass filter based on translinear conveyors," *Electron. Lett*. Vol. 31, pp. 1727-1728, 1995.
- [27] K. Ikeda, and Y. Tomita, "Realization of current-mode biquadratic filter using CCCIs with current followers," *Electronics and Communications in Japan*. Vol. 77, pp. 99-107, 1994.
- [28] A. M. Soliman, "New current mode filters using current conveyors. *Int. J. Electron. Commun. (AEU)*. Vol. 51, pp. 275-278, 1997.
- [29] P. Singthong, M. Siriruchyanun, W. Jaikla, "Electronically controllable first-order current-mode allpass filter using CCCIs and its application," *Proceedings of the 18th International Conference Mixed Design of Integrated Circuits and Systems (MIXDES)*, pp. 314-318, 2011
- [30] P. Prommee, K. Angkeaw, M. Somdunyakanok, and K. Dejhan, "CMOS-based near zero-offset multiple inputs max-min circuits and its applications," *Analog Integr. Circuits Signal Process*. Vol. 61, pp. 93-105, 2009.

**Winai Jaikla** was born in Buriram, Thailand in 1979. He received the B.Tech. Ed. Degree in telecommunication engineering from King Mongkut' Institute of Technology Ladkrabang, Thailand in 2002, M. Tech. Ed. in electrical technology and Ph.D. in electrical education from King Mongkut' Institute of Technology North Bangkok (KMUTNB) in 2004 and 2010, respectively. His research interests include electronic communications, analog signal processing and analog integrated circuit.