

Powering Pacemakers from Heart Pressure Variation with Piezoelectric Energy Harvesters

A. Mathieu, B. Aubry, E. Chhim, M. Jobe, M. Arnaud

Abstract—Present project consists in a study and a development of piezoelectric devices for supplying power to new generation pacemakers. They are miniaturized leadless implants without battery placed directly in right ventricle. Amongst different acceptable energy sources in cardiac environment, we choose the solution of a device based on conversion of the energy produced by pressure variation inside the heart into electrical energy. The proposed energy harvesters can meet the power requirements of pacemakers, and can be a good solution to solve the problem of regular surgical operation. With further development, proposed device should provide enough energy to allow pacemakers autonomy, and could be good candidate for next pacemaker generation.

Keywords—Energy harvester, heart, leadless pacemaker, piezoelectric cells, pressure variation.

I. INTRODUCTION

TODAY pacemakers are installed under the skin in patient shoulder. They are connected to heart by leads through veins and are powered by lithium batteries in order to stimulate it. They have a lifetime of up to 10 years [1] and have to be replaced at battery depletion. Usually leads are not changed, but these extra corporal objects may generate some problems like infections. To avoid them the solution is to continue improving the quality of treatment and patients' comfort. With miniaturization progress, leadless pacemakers have been developed. They do not use a battery as energy source and are directly implanted inside the heart [2]. These solutions allow reduce the invasiveness of cardiac implants and solve leads problems such as dislodgement, malfunction, fracture, infection etc.

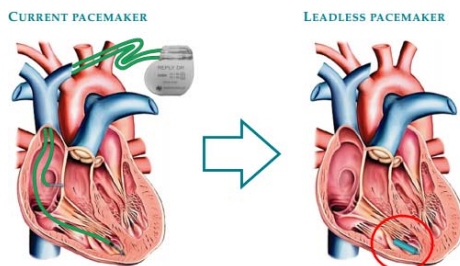

Fig. 1 Difference of Implantation between Current Pacemaker and Leadless One

Of all possible energy sources for leadless pacemakers, the only natural one is the heart mechanical energy itself [3]

A. Mathieu, B. Aubry, E. Chhim, M. Jobe, and MA. Arnaud are with ECE Paris school of engineering, Paris, 75015 France (e-mail: amathieu@ece.fr, baubry@ece.fr, mchhim@ece.fr, jobe@ece.fr, marnaud@ece.fr).

because it can last virtually infinitely and it is by definition biocompatible. Amongst all heart mechanical energy sources, piezoelectric transduction has been selected here because, with this solution, heart mechanical energy is directly converted in electrical energy [4]. More specifically, blood pressure variation during heartbeat is the chosen solution to twist a piezoelectric cell as, during each cardiac cycle, blood pressure inside right ventricle changes from 2-8 mmHg to 15-30 mmHg.

As we can see on the right ventricular pressure-volume loop relation that for each heart cycle, we have 2 brutal variation of the pressure for an almost constant volume [5]. These brutal compression and depression will be the mechanical energy to deform the piezoelectric structure. In the left ventricle, the pressure changes in higher proportions. However, it is not possible to install the pacemaker there because of high chances of rejection and difficulty of medical installation of such a device in a high-pressure chamber of the heart.

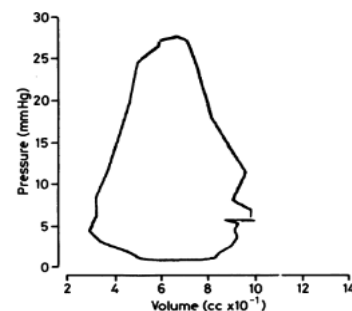

Fig. 2 Right Ventricle Volume Variation vs Pressure Variation

In left ventricle, the pressure changes in higher proportion, however it is not possible to place the pacemaker here because of high chances of rejection and difficulty of medical installation of such a device in heart high-pressure chamber.

With the blood pressure variation harvesting technique [6], it is also possible to predict the amount of produced energy because blood pressure cannot diverge dramatically from its normal value. Furthermore heartbeat excitation is very stable and reliable, and its variation is not affected by heartbeat frequency changes. However this solution needs a flexible packaging because blood pressure can be affected by atmospheric pressure variation. For example this device can be disturbed in an airplane.

II. HEART DYNAMICS BEHAVIOUR

The heart is the muscular organ that constantly pumps blood throughout the body. It is composed by 2 pumps:

- The left pump bringing oxygenated blood from the lungs to distal organs
- The right pump bringing the blood back from distal organs to the lungs to be oxygenated

Each of these pumps has two separate cavities. The atrial receives blood coming to the heart from the organs (right side) or from the lungs (left side). It delivers the blood to the ventricle that pumps the blood out of the heart to the lungs (right side) or to distal organs (left side),

The cardiac cycle is composed of two phases:

- systole
- diastole

The systole corresponds to the contraction of the heart. It is during this phase that the blood is expelled out the heart. The diastole corresponds to the relaxing of the heart. It is during this phase that the blood goes back to the heart.

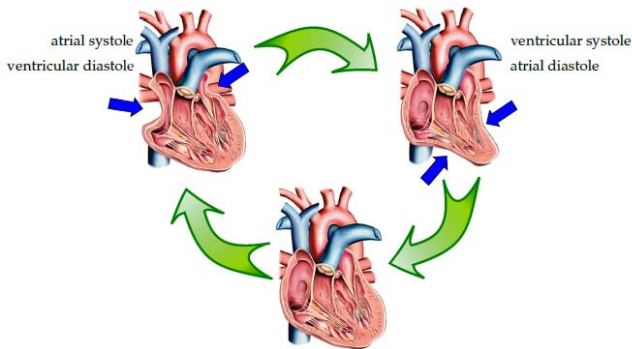

Fig. 3 Contraction Cycle of the Heart

During a cardiac cycle, the blood pressure changes in high proportion. In the right ventricle, the pressure changes with an amplitude of 20 mmHg between the systole and the diastole. In the left ventricle, this last one changes by an amplitude of 100 mmHg.

When the myocardium is contracting, a strong force is exerted on the fluid inside the cavity. Due to this last one, the blood pressure increases and expels the blood out of the cavity. Thus, the pressure is high at the exit of the heart, decreases along the vessels, and is low when the blood is back to the heart. It is the same situation for general and pulmonary circulations.

III. DESCRIPTION DEVICE

Chosen energy producing device uses pressure variation during heartbeat. This variation allows displacement or deformation of piezoelectric cells. The higher is the pressure variation, the larger is the deformation of piezoelectric cell, and consequently the more energy is produced. Its amount depends on the displacement and the characteristics of piezoelectric cells. Piezoelectric cells deformation produces an oscillating current which has to be transformed in a direct

current to make the pacemaker work. Consequently it has to be redressed and sleeked.

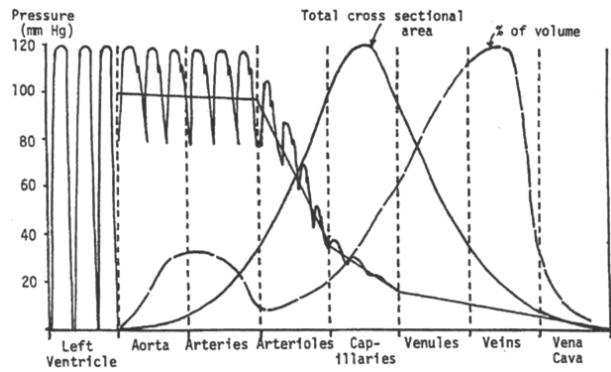

Fig. 4 Pressure Levels for the General Circulation

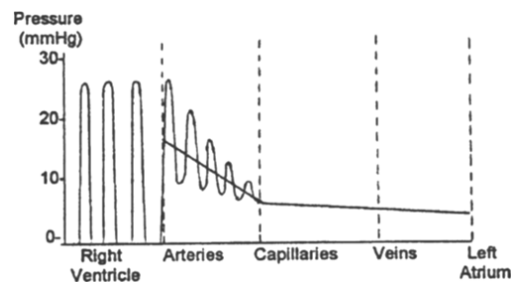

Fig. 5 Pressure levels for the pulmonary circulation

To make the pacemaker works, the following device is used:

- A diode bridge to redress the current [7]
- A capacitor to smooth out the current

A microcontroller ARDUINO and a pressure sensor are also used to measure pressure variation. Then the device is installed in a hermetic flexible packaging to simulate the right ventricle. A force is applied on this last one to create a pressure variation and thus to twist piezoelectric cells. This pressure variation can be measured with pressure sensor.

IV. RESULTS

A. Theoretical Considerations

The device is composed of two parts. A first one is fixed while another one is moved by the pressure variation. The moving parts can perform radial and longitudinal displacements.

$$W_{pressure} = \iiint_{\text{packaging cycle}} P \cdot dx \cdot d\epsilon \cdot \text{sign} \left(\frac{dP}{dt} \right) \quad (1)$$

$$W_{pressure} = A \int_{\text{cycle}} P \cdot dx \cdot \text{sign} \left(\frac{dP}{dt} \right) \quad (2)$$

$$W_{pressure} = 4A \int_{P=0}^{\frac{P_{\text{systole}} - P_{\text{diastole}}}{2}} P \cdot dx \quad (3)$$

$$W_{pressure} = 4A \cdot \frac{1}{2} \cdot \frac{P_{\text{systole}} - P_{\text{diastole}}}{2} \cdot x_{\text{max}} \quad (4)$$

$$W_{pressure} = (P_{systole} - P_{diastole}) \cdot A \cdot x_{max} \quad (5)$$

with P the pressure, dx the displacement and A the moving part area.

The device has to be flexible to create a displacement under pressure variation. This mechanical energy is transformed by the transducer into electrical energy. As the mass of the moving parts is very small, the system resonance frequency is

very large compared to heartbeat. Therefore it can be considered here that inertial effects are negligible and that system mechanical behavior is accurately described in a quasi-static approximation. A description of the system is proposed by using (8) where the packaging deformation induces a change in volume.

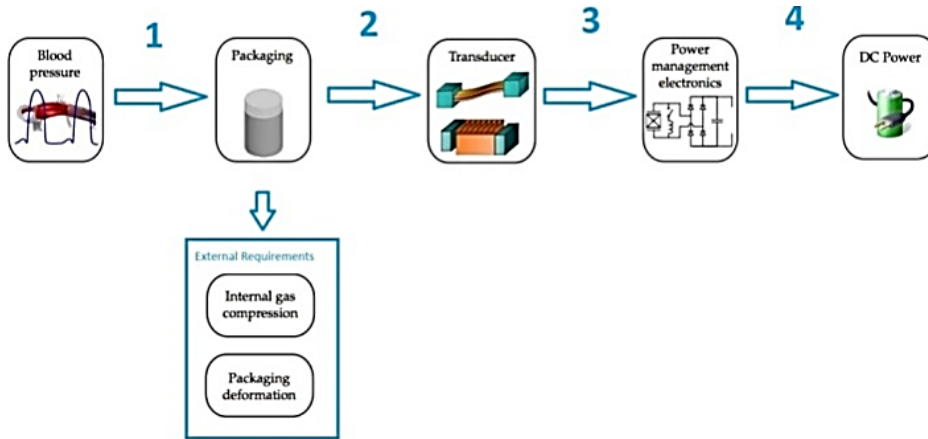

Fig. 6 Sketch of the Steps from Piezoelectric Cell to Pacemaker

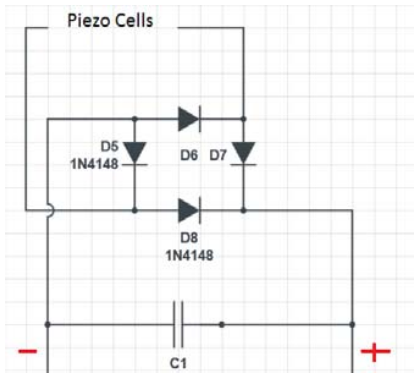

Fig. 7 AC → DC Converter Device

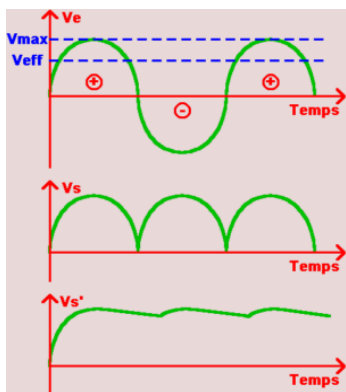

Fig. 8 AC → Obtained Voltage Curves

$$Pe(t) = Pi(\Delta V) + Ppack(\Delta V) + Ptrans(\Delta V) \quad (6)$$

Pe refers to the external pressure, Pi to the internal pressure, $Ppack$ to the stiffness of the packaging and $Ptrans$ to the transducer rigidity.

$$\int_{Pb=0}^{Pb=Pb,max} Pe(t)dV = \int_{Pb=0}^{Pb=Pb,max} Pi(\Delta V)dV + \int_{Pb=0}^{Pb=Pb,max} Ppack(\Delta V)dV + \int_{Pb=0}^{Pb=Pb,max} Ptrans(\Delta V)dV \quad (7)$$

$$\int_{Pb=0}^{Pb=Pb,max} (Pe(t) - Pi(\Delta V = 0))dV = \int_{Pb=0}^{Pb=Pb,max} (Pi(\Delta V) - Pi(\Delta V = 0))dV + \int_{Pb=0}^{Pb=Pb,max} Ppack(\Delta V)dV + \int_{Pb=0}^{Pb=Pb,max} Ptrans(\Delta V)dV \quad (9)$$

Win refers to the input mechanical energy, $Wgas$ to the energy stored in the internal gas, $Welast$ to the elastic energy of the packaging that is stored when the packaging is deformed, $Wmecha$ to the mechanical energy that effectively enters into the transducer.

These quantities are calculated for a quarter cardiac cycle. However for a whole cycle the net deformation of the packaging and the net gas compression energies $Welast$ and $Wgas$ are zero: their stored energy for the first (and third) quarter cycle is given back to the blood during the second (and fourth) quarter cycle.

Thus, it is only $Wmecha$ that can be transformed in electrical energy. However, only a part of $Wmecha$ will be transformed.

By using (8), it can be deduced that the packaging has to be as flexible as possible for two reasons:

- First, the more flexible is the packaging, the higher the change in volume will be and therefore the higher Win will be.

- Second, the more flexible is the packaging, the less energy is gone in W_{elast} for a given change in volume. Hence, a larger part of the input energy W_{in} is transferred to the transducer as W_{mecha} .

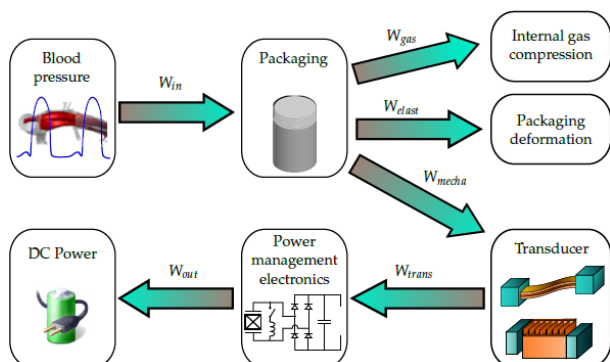

Fig. 9 Energy Flow in Blood Pressure Energy Harvesting

B. Energetic Requirements

The constraints on the device are imposed by pacemaker requirements. These last ones are the energy consumption and the value of the current to make it work. Nowadays a pacemaker needs an entry current of about 3V and consumes about $5 \mu\text{W}$ [8]. These values are anticipated to decrease in future years with scientific and technical advances.

Twisting several piezoelectric cells, it is possible to charge and discharge a capacitor in a 3V LED [9]. This experiment allows simulate simply the charge and discharge of a 3V battery and to switch on continuously a 3V LED. This experiment shows that a DC voltage generator can be constructed which is able to make a pacemaker work only using piezoelectric cells.

However, the value of pressure variation in the right ventricle has to be respected. In last experiment, the device has been encapsulated in a hermetic flexible packaging, and application of a varying pressure was generating a pressure variation similar to right ventricle variation, i.e. a variation of about 20 mmHg. This pressure variation creates a displacement of piezoelectric cells which generates an AC current. Thus, it is possible to create an AC current respecting the pressure variation of about 20 mmHg in the right ventricle [10]. Obviously heart frequency beat which is about 1 Hz has to be respected.

C. Medical Requirements

The device has to be implanted in the right ventricle. Thus, used materials have to be biocompatible. They cannot be toxic for the hearth. Furthermore, the device should not disturb heartbeat itself. This is the reason why it is proposed to encapsulate the electronic device in a titanium packaging [11]. Piezoelectric cells have to be twisted but they cannot be in contact with blood. They have to be encapsulated in a flexible packaging. To solve this problem, it is proposed to encapsulate these cells in a hemo-compatible bio membrane from calf pericardium. This membrane, already used for heart valves, is flexible and allows piezoelectric cell deformation. The whole

device should not have a size of more than 20% of already used for heart valves already used for heart valves right ventricle.

V. CONCLUSION

Heart pressure variation is a promising energy source to make a leadless pacemaker works. This energy source already allows meet pacemaker requirements despite many accessible improvements in design and performance [12]. In future years, this kind of pacemaker could be the new generation offering more comfort for patients, inasmuch as many improvements about piezoelectric cells are possible in their design and their performance.

ACKNOWLEDGMENT

The authors are very much indebted to ECE Paris School of Engineering to have provided the environment where the work has been developed, to the Professors who guided them during their research, to Dr. Marck for organization and planning, and to Pr. M. Cotsaftis for help in preparing the manuscript.

REFERENCES

- [1] T Gopinathan, K P Arul Shri: *Simulation of Recharging Battery of the Pacemaker using Piezoelectric Crystal from the Pulse in Aorta*, Thesis, Dec 2011.
- [2] H.W. Ko: US Patent 3456134A: Piezoelectric Energy Converter for Electronic Implants, 1969.
- [3] A. Badel: *Récupération d'Énergie et Contrôle Vibratoire par Éléments Piézoélectriques Suivant une Approche Non Linéaire*, Ph.D. Thesis, Université de Savoie, 2008.
- [4] M. Deterre: *Toward an Energy Harvester for Leadless Pacemakers*, Ph.D. Thesis, Paris-Sud Univ. 2013.
- [5] N. Andrew: Redington, Cardiac Dept, Brompton Hospital, Fulham Road, London SW3 6HP, in press.
- [6] R. White, G. Savage, M. Zdeblick: US Patent 7729768 B2: Implantable Cardiac Motion Powered Piezoelectric Energy Source.
- [7] S. Priya, D.J. Inman: *Energy Harvesting Technologies*.
- [8] N. Bassiri-Gharb : *Piezoelectric Mems: Materials and Devices, Piezoelectric and Acoustic Materials for Transducer Applications*, A. Safari, E.K. Akdogan, eds., Springer US, 2008, pp. 413–430.
- [9] W. Clark, C. Mo : *Energy Harvesting Technologies*, Ch.16, pp.405-430, S. Priya, D.J. Inman eds., Springer, 2009.
- [10] M. Deterre, E. Lefeuvre, E. Dufour-Gergam : *An Active Piezoelectric Energy Extraction Method for Pressure Energy Harvesting*, *Smart Materials and Structures*, Vol.21(8), 085004, 2012.
- [11] M.A. Karami, D.J. Inman: *Powering Pacemakers from Heartbeat Vibrations Using Linear and Nonlinear Energy Harvesters*, *Appl. Phys. Lett.* 100, 042901 (2012), in press.
- [12] S.R Anton, H.A Sodano : *A Review of Power Harvesting Using Piezoelectric Materials (2003–2006)*, *Smart Materials and Structures*, Vol.16(3), R1, 2007.