

Orbit Propagator and Geomagnetic Field Estimator for NanoSatellite: The ICUBE Mission

Lv Meibo, Naqvi Najam Abbas, Hina Arshad, and Li YanJun

Abstract—This research contribution is drafted to present the orbit design, orbit propagator and geomagnetic field estimator for the nanosatellites specifically for the upcoming CUBESAT, ICUBE-1 of the Institute of Space Technology (IST), Islamabad, Pakistan. The ICUBE mission is designed for the low earth orbit at the approximate height of 700KM. The presented research endeavor designs the Keplerian elements for ICUBE-1 orbit while incorporating the mission requirements and propagates the orbit using J2 perturbations. The attitude determination system of the ICUBE-1 consists of attitude determination sensors like magnetometer and sun sensor. The Geomagnetic field estimator is developed according to the model of International Geomagnetic Reference Field (IGRF) for comparing the magnetic field measurements by the magnetometer for attitude determination. The output of the propagator namely the Keplerians, position and velocity vectors and the magnetic field vectors are compared and verified with the same scenario generated in the Satellite Tool Kit (STK).

Keywords—CUBESAT, Geomagnetic Field, ICUBE-1, Orbit Propagator, Satellite.

I. INTRODUCTION

THIS paper presents the design and implementation of J2 orbit propagator along with the Geomagnetic field estimator for the Cubesat, ICUBE-1 of Institute of Space Technology (IST) [1], Islamabad, Pakistan. ICUBE-1 is the first student satellite of Pakistan that is planned to be launched in late 2013 in a sun synchronous orbit at an altitude of 700KM. The payload consists of CMOS camera that will be used for capturing photos. The detailed subsystem overview and system engineering analysis is given in [2].

ICUBE-1 is the first experimental CUBESAT of this series that is being developed by IST to provide hands on experience to its student about the satellite technology. Cubesat concept [3], initially proposed by Bob Twiggs has gained a wide appreciation all over the globe due to its technical and economic feasibility. Cubesat projects have drawn broad area of applications especially for Earth observation, formation flying, reconnaissance and many military applications.

This paper proceeds in a following sequential manner. Section II presents the Keplerian orbit design of ICUBE-1 while addressing the Keplerians calculations, simple orbit propagator and J2 Orbit propagator while comparing the MATLAB and STK [4] results. The orbit and geomagnetic

field Simulink model is presented in Section III and Section IV analysis the propagator and estimator while Section V presents the implementation flow diagram of the design and implementation of J2 orbit propagator along with geomagnetic field estimator for the ICUBE-1 and paper concludes with some conclusion and recommendations.

II. ICUBE-1 KEPLERIAN ORBIT DESIGN

A. Orbit Design and Keplerian Elements of ICUBE-1

Orbit of a satellite is its trajectory in space. This trajectory is disturbed by many perturbing effects. These effects are taken into account according to the type of the orbit propagator developed. These perturbations are due to Earths gravity, aerodynamic drag and third body effects.

For the ICUBE mission a nearly circular orbit with Altitude of 700 KM and inclination of 98.8 degrees is designed with period of 97.72 minutes. The orbit design has been simulated in STK as shown in Fig. 1.

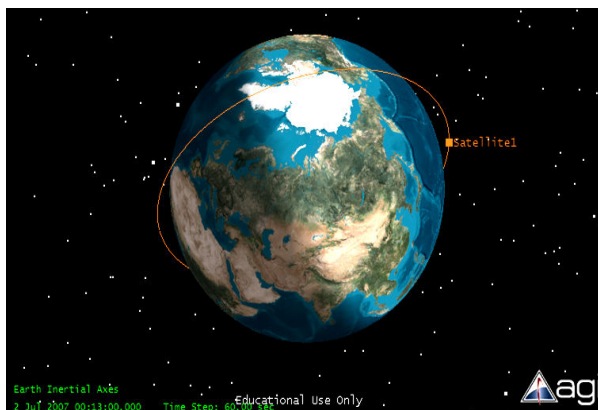

Fig. 1 ICUBE-1 Orbit in STK

The initial Keplerian elements are computed that describe the shape and size of the orbit of ICUBE-1. These Keplerian elements are the basics for the development and implementation of simple orbit propagator, J2 propagator or HPOP propagator. The six Keplerian Elements are propagated to get the position and velocity at every time step. Keplerians are found using the equations as shown in the Table I.

Lv Meibo is lecturer at School of Astronautics, Northwestern Polytechnical University, Xi'an, China with specialization in navigation, guidance and control. (phone: 0086-15829682227; e-mail: nwpuet@nwpu.edu.cn).

Naqvi Najam Abbas is PhD candidate at School of Astronautics, Northwestern Polytechnical University, Xi'an, China (phone: 0086-15129299607; e-mail: najm_naqvi@yahoo.com).

TABLE I
KEPLERIAN CALCULATIONS

Inclination: It is an angle between the equatorial plane and the orbital plane. It is the angle between the unit vector K and the angular momentum vector h . Inclination is usually between 0 to 180 degrees

Right ascension of ascending node: It is an angle, measured at the center of the earth, from the vernal equinox to the ascending node. By convention, the right ascension of ascending node is a number between 0 and 360 degrees

Argument of Perigee: Argument of perigee is the angle from ascending node to the perigee. Conventionally it's taken between 0 to 360 degrees.

Eccentricity (e): Eccentricity defines the shape of the orbit. If the eccentricity is 0 then the orbit is circular, when eccentricity is 1 then orbit is purely ellipse. Eccentricity lies between 0 and 1

Mean Motion (n): It is the average angular velocity, or number of revolutions per days. It describes the size of the ellipse

Mean Anomaly (M): Mean anomaly is an angle that marches uniformly in time from 0 to 360 degrees. Mean anomaly is 0 degrees at perigee and 180 degree at apogee. Different anomalies are used such as true anomaly (v) and eccentric anomaly (E).

$$\cos(i) = \frac{\hat{K} \cdot \vec{h}}{|\hat{K}| |\vec{h}|}$$

$$\cos(\Omega) = \frac{\hat{I} \cdot \vec{n}}{|\hat{I}| |\vec{n}|}$$

If $(n_j \leq 0)$ then $\Omega = 360^\circ - \Omega$

$$\cos(\omega) = \frac{\vec{n} \cdot \vec{e}}{|\vec{n}| |\vec{e}|}$$

If $(e_k \leq 0)$ then $\omega = 360^\circ - \omega$

$$\vec{e} = \frac{\vec{v} \times \vec{h}}{\mu} - \frac{\vec{r}}{r}$$

$$n = \sqrt{\frac{\mu}{a^3}}$$

$$\cos(v) = \frac{\vec{e} \cdot \vec{r}}{|\vec{e}| |\vec{r}|} \quad \text{If } (\vec{r} \cdot \vec{v} \leq 0)$$

then $v = 360^\circ - v$

$$\tan(E/2) = \sqrt{\frac{1-e}{1+e}} \tan(v/2)$$

$$M = E - e \sin E$$

The graphical representation of these Keplerian elements has been given in Fig. 2 [5].

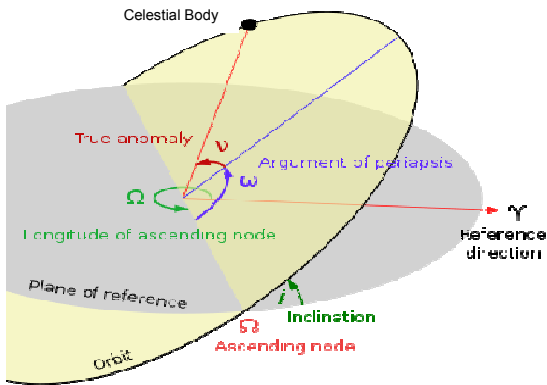

Fig. 2 Keplerians Graphical Representation

The Keplerian elements found using equations in Table I for simple orbit design can be tabulated as shown in Table II.

TABLE II
KEPLERIAN ELEMENTS

| Keplerians | Value |
|------------|-----------------|
| i | 97.9908° |
| Ω | 279.066° |
| ω | 0° |
| e | $9.86986e-007$ |
| a | 7028.14 |
| M | 0 |

The ground track obtained for the computed Keplerians and simple orbit design is simulated in STK as shown in Fig 3.

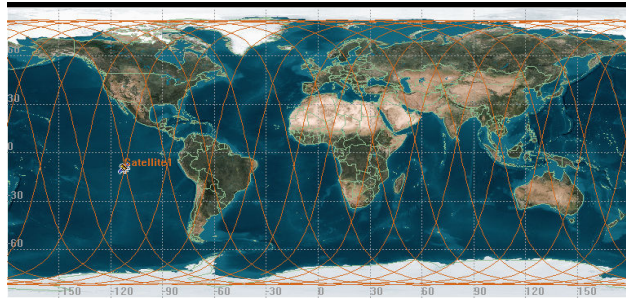

Fig. 3 Ground Track of ICUBE-1

B. Simple Orbit Propagator

Simple orbit propagator is developed by propagating the Keplerian elements without taking into consideration of any perturbations on the orbit. Keplerians elements propagation from the developed orbit propagator in MATLAB is compared with the same dynamic scenario generated in the STK as shown in the Figs. 4 and 5 that verify the design and calculation.

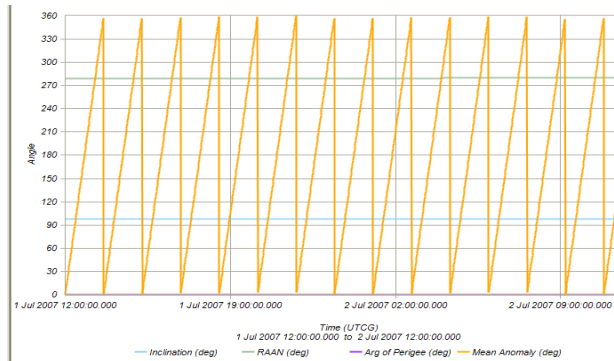

Fig. 4 Keplerian Elements from STK

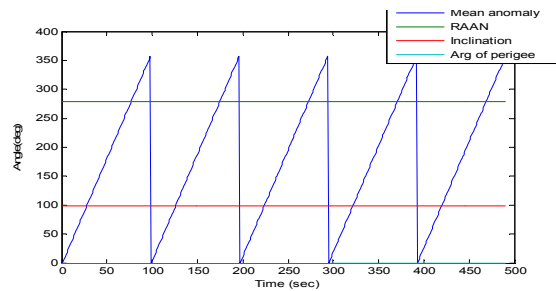

Fig. 5 Keplerian Elements from MATLAB

C.J2 Orbit Perturbations

J2 orbit propagator is developed for I-CUBE while considering the perturbations due to non-spherical earth, solar radiations and third body gravitation. This perturbation mainly affects the right ascension of ascending node, argument of perigee and mean anomaly which can be defined using (1)-(3).

$$\dot{\Omega} = -\frac{3}{2} J_2 n \left(\frac{R_E}{a}\right)^2 (1 - e^2)^{-2} \cos(i) \quad (1)$$

$$\omega = -3 n J_2 [1 - 5 \cos^2(i)] \left(\frac{R_E}{a}\right)^2 \frac{1}{4} (1 - e^2)^{-2} \quad (2)$$

$$\dot{M} = n + \frac{3 J_2 n [3 \cos^2(i) - 1]}{4 (1 - e^2)^{3/2}} \left(\frac{R_E}{a}\right)^2 \quad (3)$$

The Keplerian elements and the position and velocity vector found by the J2 orbit propagator are compared and verified with the satellite tool kit (STK) and the results are shown in Figs. 6-9.

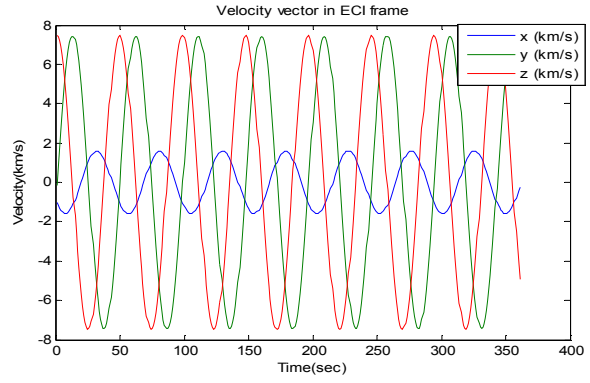

Fig. 9 Velocity Vector in ECI from J2 Orbit Propagator

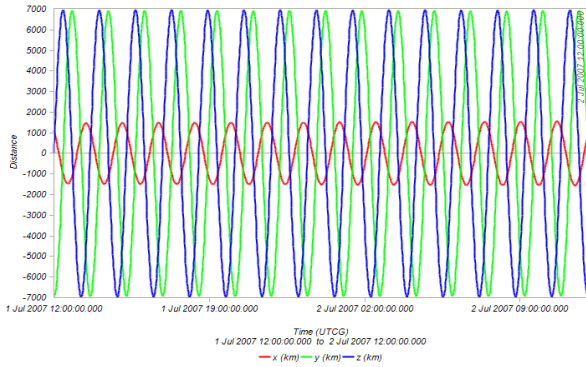

Fig. 6 Position Vector in ECI Frame from STK

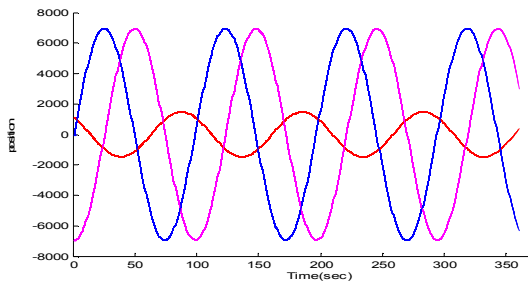

Fig. 7 Position Vector in ECI Frame from J2 Orbit Propagator

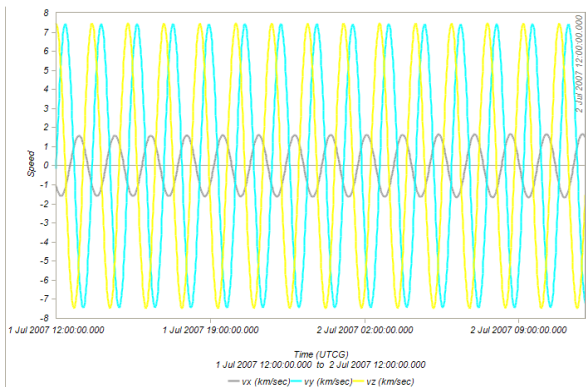

Fig. 8 Velocity Vector in ECI Frame from STK

III. SIMULINK MODEL OF ORBIT PROPAGATOR AND GEOMAGNETIC FIELD ESTIMATOR

The Simulink model was developed for the J2 orbit propagator and geomagnetic field estimator and has been shown in Fig. 10.

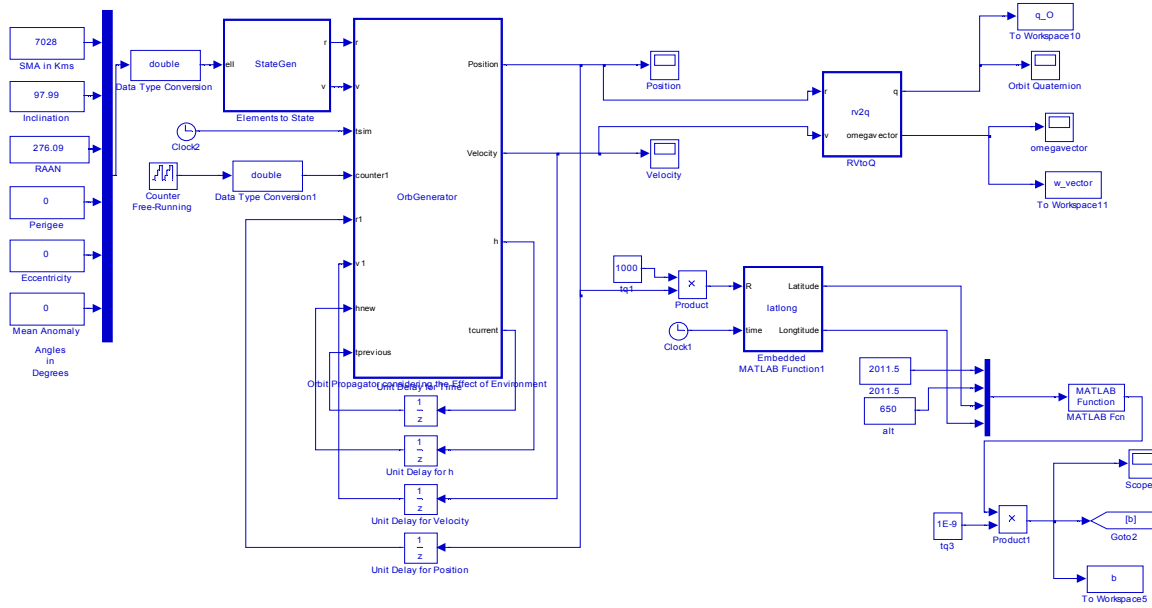

Fig. 10 Simulink model of Orbit Propagator and Geomagnetic Field Estimator

IV. GEOMAGNETIC FIELD ESTIMATOR

Attitude determination of the ICUBE-1 involves the determination of geomagnetic field by the magnetometer and to compare it with the International Geomagnetic Reference field (IGRF) model [6]-[7]. An IGRF model is developed for implementation in ICUBE-1 and its design and analysis details are presented in this section.

A. Coordinate Transformation

To get the estimate of magnetic field at each position on every instant, IGRF model is used and it requires the position vector in ECEF frame. To get the position in ECEF frame we need a Rotation matrix that transforms the position from ECI to ECEF. The rotation matrix is given as

$$R_E^I = R_z(\theta) \tag{4}$$

where $R_z = \begin{bmatrix} \cos(\theta) & \sin(\theta) & 0 \\ -\sin(\theta) & \cos(\theta) & 0 \\ 0 & 0 & 1 \end{bmatrix}$ (5)

where θ is the ascension of the zero meridian. The theta required for ECI to ECEF transformation can be calculated by using the epoch calendar date, day and time (UT1) and calculating modified Julian date (MJD) for it according to (6).

$$MJD = 376 \cdot year - \dots \tag{6}$$

$$+ \text{floor}\left(7 \cdot \frac{\text{year} + \text{floor}\left(\frac{\text{month} + 9}{12}\right)}{4}\right) \dots$$

$$+ \text{floor}\left(275 \cdot \frac{\text{month}}{9}\right) + \text{days} - 730531.5$$

where days can be calculated as

$$\text{days} = \text{day} + \left(\frac{\text{hour}}{24} + \frac{\text{minute}}{60} + \frac{\text{second}}{3600}\right) \tag{7}$$

Finally the θ , that is valid from 1900-2099 years is given as.

$$\theta = 280.466061837 + 360.98564736629 * MJD + 0.000388 * \left(\frac{MJD}{36525}\right)^2 \tag{8}$$

The Position vector presented in ECEF frame is shown in Fig. 11 and compared with the ECEF results from STK in Fig. 12.

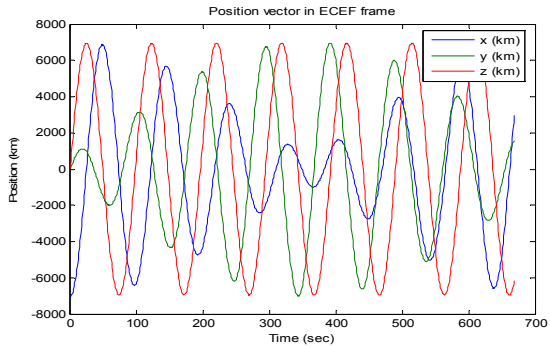

Fig. 11 Position Vector in ECEF Frame from J2 Orbit Propagator

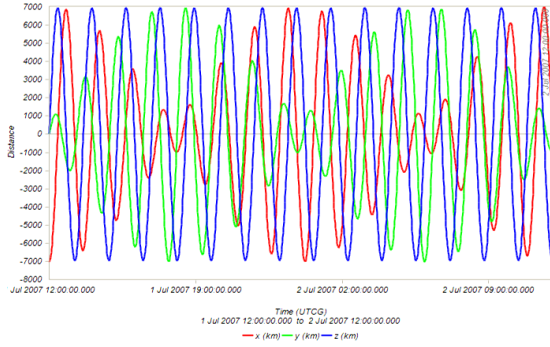

Fig. 12 Position Vector in ECEF Frame from STK

B. Geomagnetic Field Modeling

IGRF is International Geomagnetic Reference model, developed by different modelers and Institutes and describes magnetic vector field with respect to position and date. It gives spot values of Geo magnetic field. To determine the magnetic vector for comparison with magnetic vector from magnetometer, the magnetic field of Earth should be known at different positions (Latitude, Longitude). IGRF model's data is used to develop geomagnetic field estimator

The IGRF model used in this estimator is IGRF 2000 that gives Magnetic field near and above the surface of Earth with good approximation. IGRF model consist of set of spherical harmonic coefficients that are time dependent and are obtained by expanding and truncating the magnetic field potential. Mathematically it can be given as (9) [8]

$$V = a \sum_{n=1}^N \sum_{m=0}^n \left(\frac{a}{r}\right)^{n+1} (g_n^m \cos m(\phi) h_n^m \cos m(\phi)) P_m^n \cos(\theta) \quad (9)$$

where a is the equatorial radius of earth, r is the geocentric distance, ϕ is the longitude eastward from the Greenwich, θ is the colatitudes, $P_m^n \cos(\theta)$ are Schmidt quasi-normalized associated Legendre functions while m and n are the orders of the function.

The IGRF model along with Schmidt function is integrated with orbit propagator to give geomagnetic field at different positions as the orbit estimator propagates. The values thus obtained will be taken as reference to compare with the geomagnetic vector obtained through magnetometer. The geomagnetic field in geocentric frame calculated by the estimator is shown in the Fig. 13 and compared with [9] for reference.

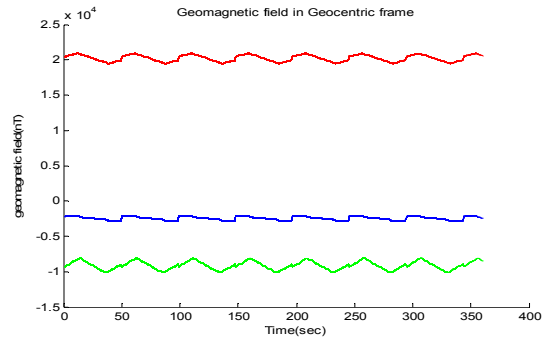

Fig. 13 Geomagnetic Field Estimation in Geocentric Frame

The Geomagnetic field in ECEF is obtained from geomagnetic estimator and is compared with STK as shown in Figs. 14 and 15.

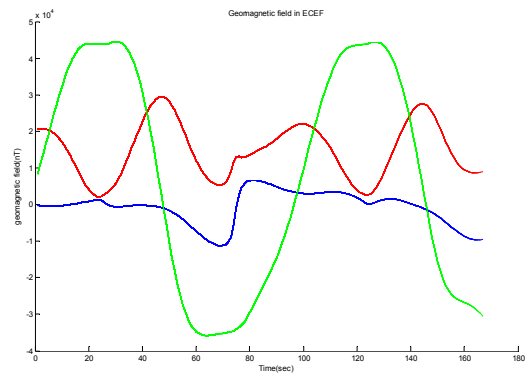

Fig. 14 Geomagnetic Field Estimation in ECEF

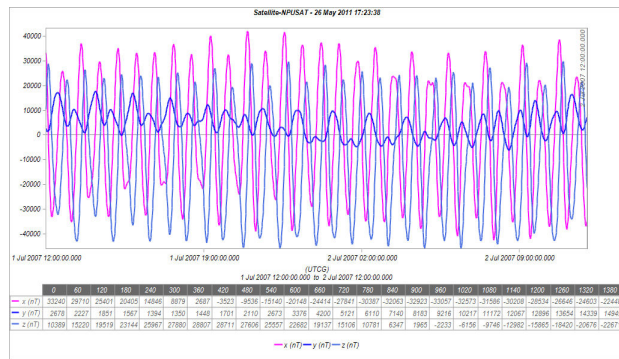

Fig. 15 Geomagnetic Field Estimation in ECEF from STK

V. FLOW DIAGRAM OF ORBIT PROPAGATOR AND GEOMAGNETIC FIELD ESTIMATOR

The flow diagram showing the basic operation incorporated in the development of MATLAB based J2 orbit propagator and magnetic field estimator is given in Fig. 16. It consists of initializing with the initial position and velocity vector and finding the Keplerians accordingly. The next step is about applying the J2 perturbations and propagating the orbit for one day. Finally IGRF model is implemented after applying the

transformations from ECI to ECEF frame and finding the geomagnetic field.

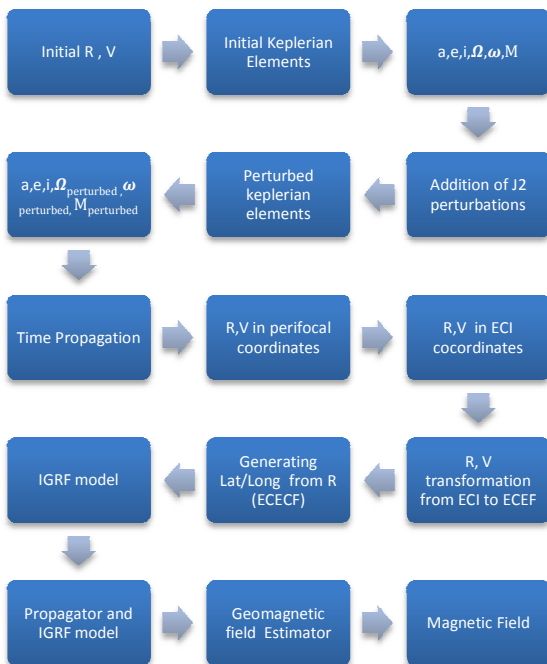

Fig. 16 Flow Diagram

- [6] S. S. Ose, Master's Thesis, "Attitude determination of the NCUBE satellite," Department of Engineering Cybernetics, June, 2003
 [7] Kristian Svartveit, Master's Thesis, "Attitude determination of the Norwegian Student Satellite NCube," Department of Engineering Cybernetics, 2004
 [8] IGRF Model, www.ngdc.noaa.gov/IAAGA/vmod/igrf.html
 [9] <http://wdc.kugi.kyoto-u.ac.jp/igrf/point/index.html>

VI. CONCLUSION AND RECOMMENDATIONS

CubeSat technology is gaining momentum with the latest trends of technology and applications. The Nanosatellite missions are moving from university sectors towards the commercial, communication and earth observation missions. Institute of Space Technology, Pakistan is developing its debut CubeSat, ICUBE-1 that is going to be launched in late 2013. This experimental student satellite has the objectives of technology learning and experimentation. This research paper presented the design of Keplerian orbit and J2 orbit propagator along with the geomagnetic field estimator developed in MATLAB environment and the results are compared with the same scenario generated with the help of satellite tool kit. All the results from STK verify and validate the propagator and estimator. This research contribution participated in the attitude determination and control system of the ICUBE-1.

ACKNOWLEDGMENT

The authors are thankful to Northwestern Polytechnical University, NPU, Xi'an China and Institute of Space Technology, IST Pakistan for research support.

REFERENCES

- [1] www.ist.edu.pk
 [2] Rehan Mahmood, Khurram Khurshid, Qamar ul Islam, "Institute of Space Technology CubeSat: ICUBE-1 Subsystem Analysis and Design", 32nd IEEE Aerospace Conference, USA, 2011.
 [3] <http://cubesat.calpoly.edu/>
 [4] Satellite Tool Kit, www.stk.com
 [5] http://en.wikipedia.org/wiki/Orbital_elements