

Optimum Design of an 8x8 Optical Switch with Thermal Compensated Mechanisms

Tien-Tung Chung, Chin-Te Lin, Chung-Yun Lee, Kuang-Chao Fan, and Shou-Heng Chen

Abstract—This paper studies the optimum design for reducing optical loss of an 8x8 mechanical type optical switch due to the temperature change. The 8x8 optical switch is composed of a base, 8 input fibers, 8 output fibers, 3 fixed mirrors and 17 movable mirrors. First, an innovative switch configuration is proposed with thermal-compensated design. Most mechanical type optical switches have a disadvantage that their precision and accuracy are influenced by the ambient temperature. Therefore, the thermal-compensated design is to deal with this situation by using materials with different thermal expansion coefficients (α). Second, a parametric modeling program is developed to generate solid models for finite element analysis, and the thermal and structural behaviors of the switch are analyzed. Finally, an integrated optimum design program, combining Autodesk Inventor Professional software, finite element analysis software, and genetic algorithms, is developed for improving the thermal behaviors that the optical loss of the switch is reduced. By changing design parameters of the switch in the integrated design program, the final optimum design that satisfies the design constraints and specifications can be found.

Keywords—Optical switch, finite element analysis, thermal-compensated design, optimum design.

I. INTRODUCTION

THE fiber-optic network is very important in high-speed data transfer because its characteristics are low-cost, lightweight and high-bandwidth [1]. Optical switches are essential devices in the fiber-optic network, and they guide signals from input ports to appropriate output ports. For NxN mechanical type optical switches, optical cross-connects (OXC) has been identified as a key technology in recent years [2]–[5]. The main components for this technology are collimators, micro mirrors and actuators. The basic unit of OXC is a cross-bar switching stage, in which the reflecting mirrors can be switched to ON or OFF states. The direction of

the light signal will be changed when the mirror is switched to ON state, or else the light signal will go straight.

Both 2D and 3D optical switches are studied for large-port-count NxN switches. The advantage of 3D switches is that the requirement is 2N mirrors, but they have difficulty in manufacturing and control [6]. On the other hand, the layout of a typical NxN OXC switch is similar to a NxN matrix and requires N² mirrors. When the port number is increased, the required mirror number is also increased. At the same time, the process to assemble the switch with large port number is also much more difficult for the small port number switch.

Many researchers studied the arrangement layout for reducing the mirror number. Ma and Kuo [6] designed an architecture layout with Benes principle. Wang [7] proposed a mirror layout method with multi-level optical switches. In these previous researches, the required mirror number is reduced and quite good results are obtained.

In addition, the optical switches have a general problem that the ambient temperature affects their precision and accuracy. The change of the ambient temperature of the optical switch usually leads to induce translations and rotations of reflecting mirrors, and optical misalignments of traveling lights are accumulated during their travel distance among reflection mirrors. In response to this kind of thermal problem, a thermal-compensated mechanism is necessary. Morey and Glomb [8] developed a thermal-compensated design for optical waveguide light filtering device. Yoffe [9] assembled a passive thermal-compensated package for fiber gratings, which is mounted in that package consisting of two materials with different thermal expansion coefficients. Also, some researchers [10]–[12] developed temperature-insensitive structures to resist the deformation while temperature rising in micro/nano mechanical devices. Lemaire [13] proposed that the material which has a large thermal expansion coefficient would make the larger deformation than that produced by the material which has a small thermal expansion coefficient. Thus, when the ambient temperature changed, the components would have convex or concave deformation shape.

In this paper, the optimum design for an 8x8 optical switch is applied. The characteristics of this switch are reducing optical loss, fewer mirrors and improved thermal behaviors. The switch layout was derived by an expert system. Besides, the thermal and structural analysis in finite element method is applied to calculate the mirrors' translations and rotations which would affect the optical losses, and the results in finite element method should pass the Telcordia test.

T. T. Chung is with the Department of Mechanical Engineering, National Taiwan University, Associate Professor, Taipei 10617 Taiwan (phone: 886-2-3366-2705; fax: 886-2-2363-1755; e-mail: ttchung@ntu.edu.tw).

C. T. Lin is with the Department of Mechanical Engineering, National Taiwan University, Ph.D. Student, Taipei 10617 Taiwan (e-mail: d94522033@ntu.edu.tw).

C. Y. Lee is with the Department of Mechanical Engineering, National Taiwan University, Graduate Student, Taipei 10617 Taiwan (e-mail: r96522603@ntu.edu.tw).

K. C. Fan is with the Department of Mechanical Engineering, National Taiwan University, Professor, Taipei 10617 Taiwan (e-mail: fan@ntu.edu.tw).

S. H. Chen is with the Department of Mechanical Engineering, National Taiwan University, Ph.D. Student, Taipei 10617 Taiwan (e-mail: d94522020@ntu.edu.tw).

II. STRUCTURAL DESIGN FOR OPTICAL SWITCHES

An expert system is developed to determine the feasibility layouts for reflecting mirrors [14]. The expert system is implemented with knowledge rules which can be used in generating the feasible mirror layouts for the NxN optical switch such that the switching states for all signal switching are fulfilled. For example, the 8x8 switch needs $8!=40320$ switching states. After all feasible mirror layouts are found out, the best mirror layout can be selected with shortest light traveling distance. The final best mirror layout is shown in Fig.1. It has 17 movable mirrors and 9 fixed mirrors. The total number of mirrors in this layout is less than Benes architecture [6] and Wang's design [7]. The size of the layout is also smaller than both of two prior layouts.

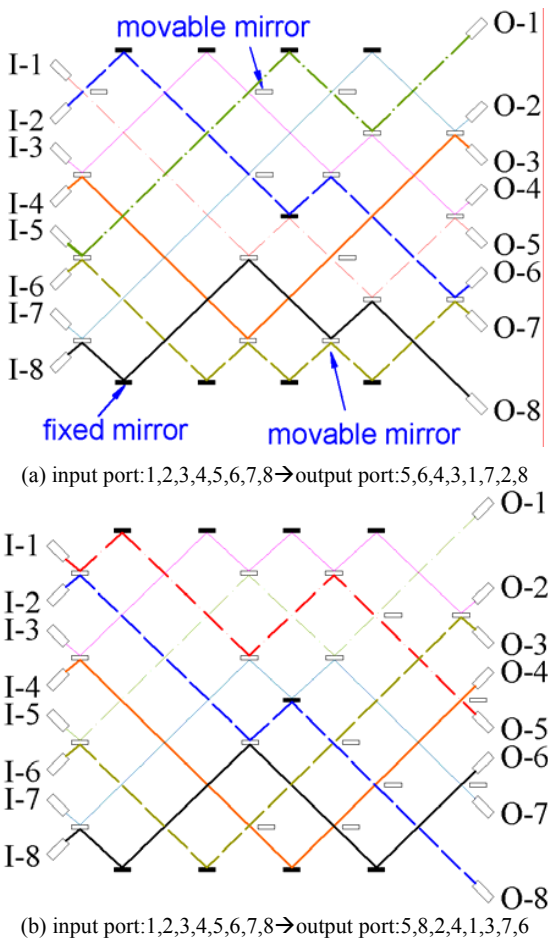

Fig. 1 The layout of the optical switch

Each reflecting mirror is fixed in an arm attached to a relay actuator. The relay TQ2-L2-5V ATQ229, as shown in Fig. 2, is selected from the commercial market. This relay has good bi-stable reliability. When it switches to OFF state and then comes back to ON state repeatedly, the relay should return to its original position. Hence, this relay is suitable to be used as the switching unit for the optical switch.

Secondly, for reducing the number of mirrors, the two long

fixed mirrors with M-type frame are used. Finally, because there are some thermal problems in optical switch, the thermal-compensated mechanisms are developed to deal with the problems, and this issue will be described in the next chapter. As a result, the model of the 8x8 optical switch can be designed and is shown in Fig. 3. This 8x8 optical switch is composed of a base, 8 input fibers, 8 output fibers, 2 long fixed mirrors with M-type frame, 1 fixed mirror, and 17 movable mirrors. The input and output fibers are located in the opposite edges of the optical switch, respectively. Every fiber has a collimator at its end to convert the light signal. The light signal may be reflected several times during it travels from an input fiber to an output fiber. The prototype of this 8x8 optical switch is shown in Fig. 4.

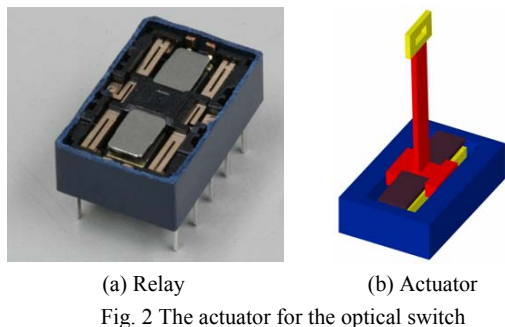

Fig. 2 The actuator for the optical switch

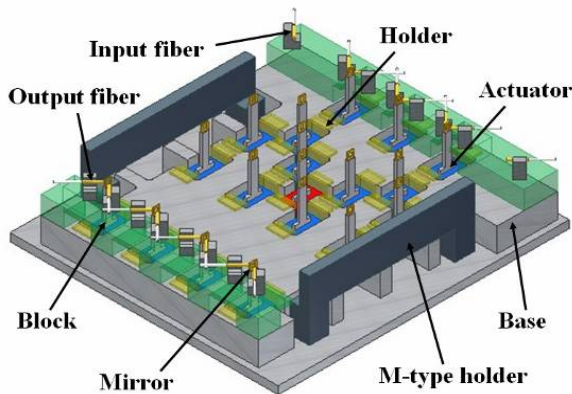

Fig. 3 The model of 8x8 optical switch

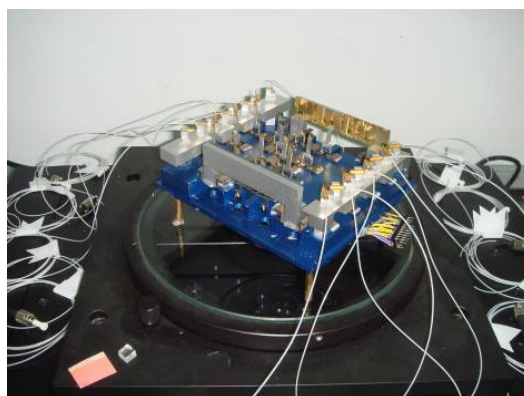
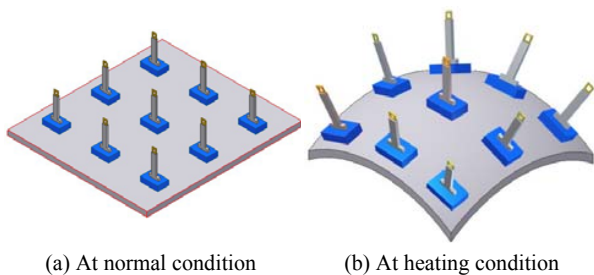

Fig. 4 Prototype of 8x8 optical switch

III. THERMAL-COMPENSATED DESIGN

One of the important performances of optical switches is the high reliability in signal transfer. However, optical switches, one kind of precise machine, are sensitive to temperature change. The thermal loadings of optical switches include heat generation of actuators and the surface heat convection due to ambient temperature. Because the relay of actuators is uses electricity, it will produce heat generation and then raises up the temperature. This situation will cause movements between base and actuators. Aside from the problem of heat generation, optical switches have another problem from the environmental temperature. Optical switches are usually working in different environments, so the Telcordia testing defines a standard that optical switches must have the ability to work in the temperature range of -40 °C to 70 °C. When ambient temperature rises up or cools down, the change of the body temperature may make the optical switches produce thermal deformation and decrease the reliability of optical signal. Therefore, optical switches need a solution to overcome these thermal problems.

Although a simple structure can be proposed easily to construct the layout mentioned before, as shown in Fig. 5(a), it is easily affected by temperature change. When relay temperature arises, the base of the optical switch has the convex deformation, as shown in Fig. 5(b). This deformation will result in translational offsets or angular rotations of reflecting surfaces of mirrors. If a mirror moves away its correct position, the corresponding light path would be also changed so that the collimators would not receive the light signal.



(a) At normal condition (b) At heating condition

Fig. 5 The thermal deformation of optical switches

There are two types of thermal deformation [13], as shown in Fig. 6. One is induced by a non-uniform temperature distribution in the structure. A non-uniform temperature distribution in the structure will cause the non-uniform thermal deformation, as shown in Fig. 6(a), since the deformation in the top surface is larger than that in the bottom surface. The other phenomenon is that the components have different thermal expansion coefficients. The magnitude of thermal deformation is proportional to the thermal expansion coefficient for general materials. Therefore, a structure composed of two materials with different thermal expansion coefficients usually produces a deformation due to temperature change, as shown in Fig. 6(b). Furthermore, the contact area between two materials enhances the thermal deformation as usual [15], and the response can be schematized as shown in Fig. 7. It can infer that the

deformation is larger with increasing of the contact area. Thus, the thermal-compensated design is proposed as a solution for the optical switch and is described in the following.

The origin of optical loss is due to variety of light paths. The light paths between input and output collimators in optical switches using OXC are constructed by mirrors. Hence, keeping the mirrors' positions is the main objective for thermal-compensated design. However, not all directions of a mirror's motion affect the light paths. For example, when a light path is reflected by x-y plane in 3D space, only the translation in z-direction, the rotation about x-axis, or the rotation about y-axis have great influences on the reflected light direction, and these three directions are called sensitive directions in this paper. If a mirror has a motion in the sensitive direction, the optical loss would be increased.

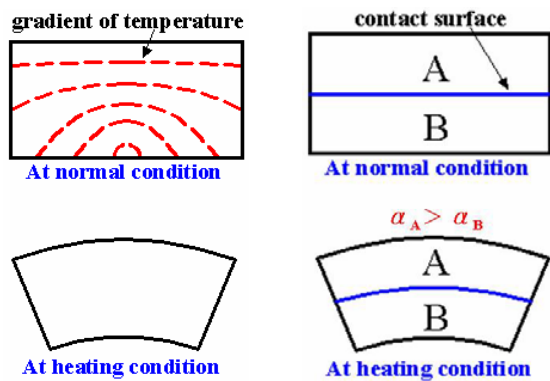

(a) Non-uniform temperature (b) Materials with different thermal coefficient

Fig. 6 Two types of thermal deformation

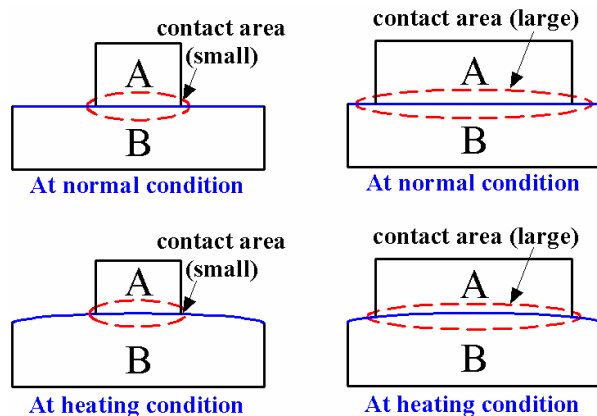

Fig. 7 The thermal behavior of contact areas

The thermal-compensated design will keep small mirror rotations and avoid mirror motions in sensitive directions. In addition, collimators for long distance light paths have their specification for lateral offset and angular misalignment. In this paper, the allowable lateral offset of collimators is 100µm and the allowable angular misalignment is 0.035°. It means that mirror rotations are sensitive directions, and even for small value of mirror rotations it makes more optical loss than those

of insensitive directions – mirror translations. So, thermal compensated design should avoid mirrors being deformed in angular directions. In order to avoid the motions of mirrors in sensitive directions, the thermal compensated design is proposed based on the following rules.

- 1) Avoid the base deformation which usually produces mirrors' rotations in the sensitive directions.
- 2) Avoid the arms' motions in the sensitive directions.

Hence, the first rule is to prevent actuators from being contact with the base, or else the contact of both components will cause the base deformation which would make mirrors' rotations. Then, the next step is to adjust the behavior of arm for refining the mirror's motions.

In order to reduce the optical signal loss induced by the base deformation, first of all, the holder of actuators and a new base structure are proposed and are shown in Fig. 8. The new actuators which add the holders, as shown in Fig. 9, and the new base, as shown in Fig. 8, are presented to avoid the condition that the relay actuators contact the base directly. Thus, this structure can reduce the thermal deformation effectively between base and actuators. For the best performance, the material should be chosen correctly. There are four materials with different thermal expansion coefficients for the base, the holders, the relays and the mirrors. The best way to assembly them is to conjunct of two materials whose thermal expansion coefficients are close to each other. In this paper, the base and the arms are made of aluminum alloy, the relays are mainly made of liquid crystal polyester (LCP), the holders are made of steel and the mirrors are made of silicon wafer, as shown in Fig. 9. Therefore, the material of the holder is chosen in steel, and the deformation of the base and actuators will be reduced greatly.

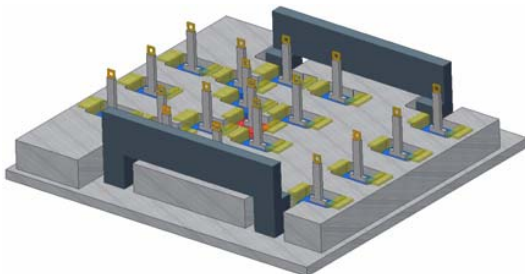

Fig. 8 The structure design for 8x8 optical switch

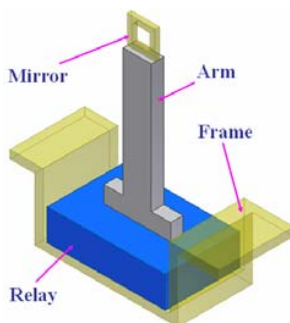

Fig. 9 Structural materials of actuator

It is important to regular the motion of arms and mirrors, and to keep their motion from the sensitivity directions. Fig. 10 shows two assemblies of an actuator, a holder and the base. The actuator and the holder are assembled together and their thermal expansion coefficients are different. When the body temperature changes, the structure will cause an unexpected deformation and make the mirror's motion in the sensitive directions. Fig. 10(a) shows a worse case. In the case, the light signal is reflected in x-z plane, but the deformation makes the mirror rotate about x-axis which is a sensitive direction. Thus, a better design is proposed and is shown in Fig. 10(b). The light signal is reflected in y-z plane, but the deformation makes the mirror rotate about y-axis which is not the sensitive direction. As the result to this design concept, the unexpected error from thermal deformation or assembling can be reduced greatly at the better design.

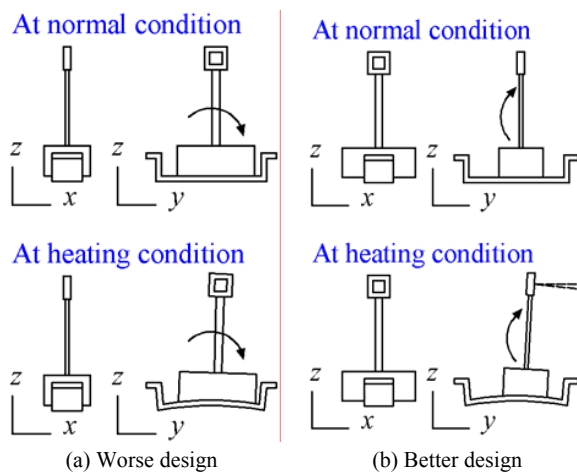

Fig. 10 Two types of holders and mirrors

IV. ANALYSIS OF OPTICAL SWITCH

A series of finite element analyses was carried out to determine whether this switch satisfy Telcordia testing standards or not. For the tests, 8x8 optical switch is placed in a $-40\text{ }^{\circ}\text{C}$ and $70\text{ }^{\circ}\text{C}$ environment, respectively, and then they are removed to ambient temperature. During the test, the optical loss of an 8x8 optical switch should lower than -3.0 dB .

Because of the symmetry, the half model is used to be the finite element meshed model. A type of thermal analysis element was applied to calculate the temperature distribution of the optical switch, and then the deformation can be solved with a structural element transferred from the thermal element. The boundary conditions are shown in Fig. 11.

The meshed model is shown in Fig. 12, and has 71,212 elements. The heat generation of each relay is 0.0471 watt. Natural air convection is also considered. The main goal of the finite element analysis is to simulate the critical working conditions of the optical switch, mainly at ambient temperature $-40\text{ }^{\circ}\text{C}$ and $70\text{ }^{\circ}\text{C}$. The material properties are listed in Table I.

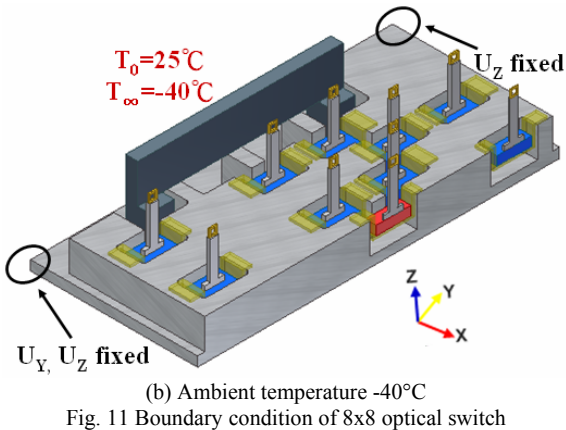
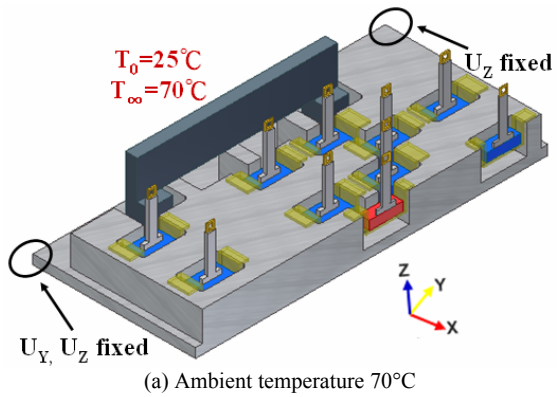

Fig. 11 Boundary condition of 8x8 optical switch

Table III, and the maximum lateral offset of the mirrors are 110µm at ambient temperature 70 °C, and 150 µm at ambient temperature -40 °C. The translational and rotational motion from the thermal deformation is large in the range of the collimator’s specification.

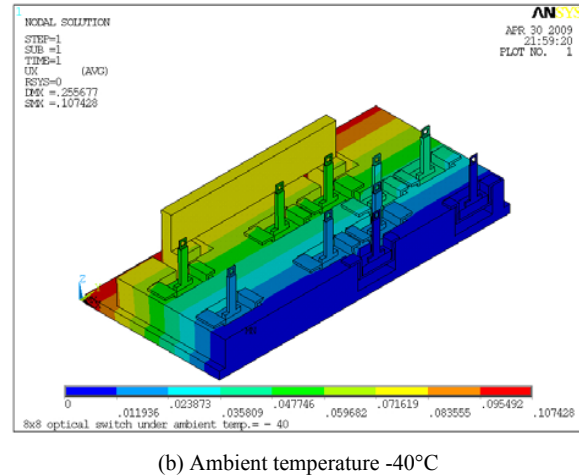
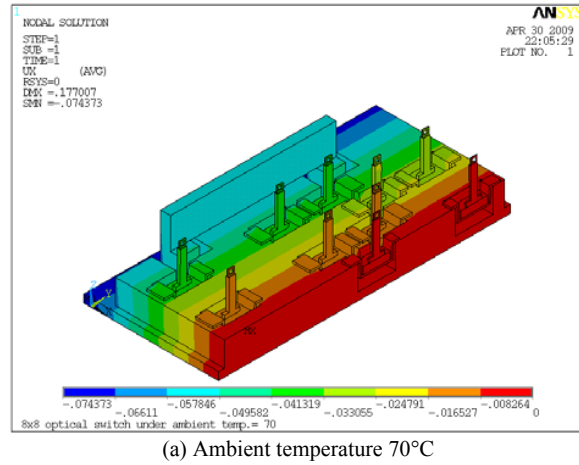

Fig. 13 Thermal deformation diagrams

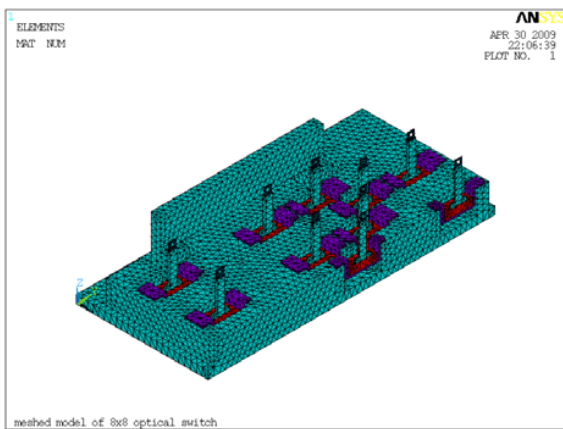

TABLE I
MATERIAL PROPERTIES OF THE OPTICAL SWITCH

	Young's modulus (kgf/mm ²)	Poisson ratio	Thermal conductivity (W/mm-°C)	Thermal expansion coefficient (1/°C)
LCP	700	0.35	0.00015	5.0x10 ⁻⁶
Al-alloy	7300	0.30	0.010	24x10 ⁻⁶
Steel	21122	0.30	0.0519	11.7x10 ⁻⁶
Silicon wafer	11457	0.22	0.124	2.49x10 ⁻⁶

The simulation results thermal deformations are shown in Fig. 13. The displacements of mirrors are shown in Table II and

TABLE II
TRANSLATIONAL MOTION OF MIRRORS AT AMBIENT TEMPERATURE 70°C

	70°C		
	x (mm)	y (mm)	z (mm)
1	-0.0252	0.1379	0.0316
2	-1.92E-05	0.1380	0.0309
3	-0.0518	0.1124	0.0312
4	-0.0251	0.1139	0.0302
5	-0.0368	0.0993	0.0308
6	-0.0143	0.0995	0.0295
7	-0.0521	0.0859	0.0320
8	-1.75E-05	0.0890	0.0294
9	-0.0523	0.0594	0.0322
10	-0.0361	0.0753	0.0313
11	-0.0132	0.0754	0.0301
12	-0.0524	0.0320	0.0321
13	-0.0377	0.0220	0.0326
14	-0.0128	0.0218	0.0316

TABLE III
 TRANSLATIONAL MOTION OF MIRRORS AT AMBIENT TEMPERATURE -40°C

-40°C			
	x (mm)	y (mm)	z (mm)
1	0.0364	-0.1993	-0.0456
2	2.77E-05	-0.1994	-0.0447
3	0.0749	-0.1624	-0.0451
4	0.0363	-0.1645	-0.2409
5	0.0532	-0.1434	-0.0445
6	0.0207	-0.1437	-0.0427
7	0.0752	-0.1241	-0.0462
8	2.52E-05	-0.1285	-0.0425
9	0.0756	-0.0858	-0.0466
10	0.0521	-0.1088	-0.0453
11	0.0191	-0.1090	-0.0435
12	0.0757	-0.0462	-0.0464
13	0.0544	-0.0317	-0.0471
14	0.0185	-0.0316	-0.0457

V. OPTIMUM DESIGN FOR 8X8 OPTICAL SWITCH

Many considerations for application in structural design are required, such as safety, applicability and production cost. Therefore, appropriate constraints are added into optimization problems to find the feasible design under constraints. The general structural optimization problem can be written mathematically as follows:

$$\begin{aligned} &\text{Find } \bar{x}, \text{ such that } F(\bar{x}) \rightarrow \min. \\ &\text{Subject to: } g_i(\bar{x}) \leq 0, \quad i = 1, 2, \dots, n_c \end{aligned} \quad (1)$$

where $\bar{x} = (x_1, x_2, \dots, x_n)$ is the vector of the design variables, n_v is the number of design variables, $F(\bar{x})$ is the objective function, $g_i(\bar{x})$ is the i^{th} constraint and n_c is the total number of constraints.

For verifying the optical losses of the optical switch which are in the range of allowable value, each rotation of mirror should be found out. Three points of each mirror are defined as Fig. 14(a). In Fig. 14(b), point A, B and C are the points in a mirror at its original position, so the original position vectors can be indicated as \vec{A} , \vec{B} and \vec{C} . After the mirror moves, the position vectors of the mirror are \vec{A}' , \vec{B}' and \vec{C}' . The displacement vectors of these points from the original position to the deformed position are \vec{a} , \vec{b} and \vec{c} . The relationships between the original position vectors and the deformed position vectors have been derived in reference [14], and are summarized as following:

$$\vec{A}' = \vec{A} + \vec{a} \quad (2)$$

$$\vec{B}' = \vec{B} + \vec{b} \quad (3)$$

$$\vec{C}' = \vec{C} + \vec{c} \quad (4)$$

The normal direction of the mirror in its original position is defined as \vec{N} , and that from the original position to the deformed position is defined as \vec{N}' . To ignore the surface

curvature due to the thermal deformation, the normal directions can be specified as equation as following:

$$\vec{N} = \vec{BA} \times \vec{BC} = (\vec{A} - \vec{B}) \times (\vec{C} - \vec{B}) \quad (5)$$

$$\vec{N}' = \vec{B'A'} \times \vec{B'C'} = (\vec{A}' - \vec{B}') \times (\vec{C}' - \vec{B}') \quad (6)$$

The relationship between the rotation angle θ and the two normal vectors can be expressed as:

$$\vec{N}' \cdot \vec{N} = |\vec{N}'| |\vec{N}| \cos \theta \quad (7)$$

Thus, the rotation angle θ can be solved from the previous equation as:

$$\theta = \cos^{-1} \frac{\vec{N}' \cdot \vec{N}}{|\vec{N}'| |\vec{N}|} \quad (8)$$

After all mirrors' rotations are determined, the misalignments of all optical paths can be found out. The name of each mirror is numbered as Fig. 15. Because of the symmetry of the model, only 14 mirrors need to be numbered. The rotation angles of these mirrors are listed in Table 4.

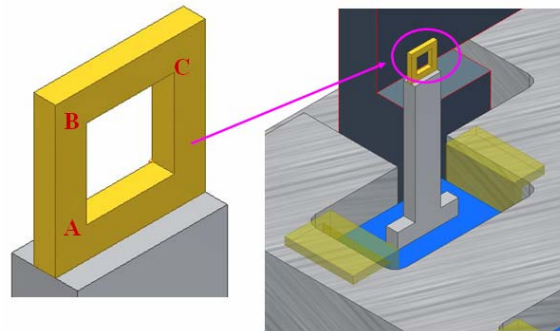

(a) Points A, B, C of a mirror

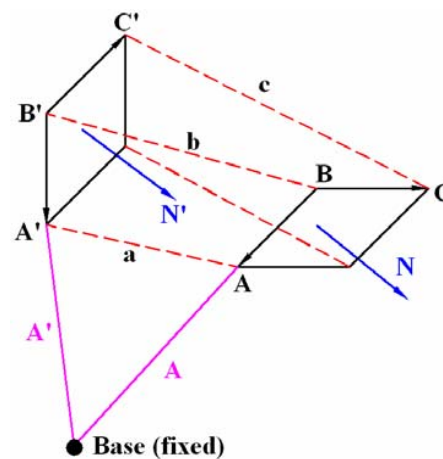

(b) The position change of a mirror and the normal vector

Fig. 14 Diagram for calculation of mirror's rotation

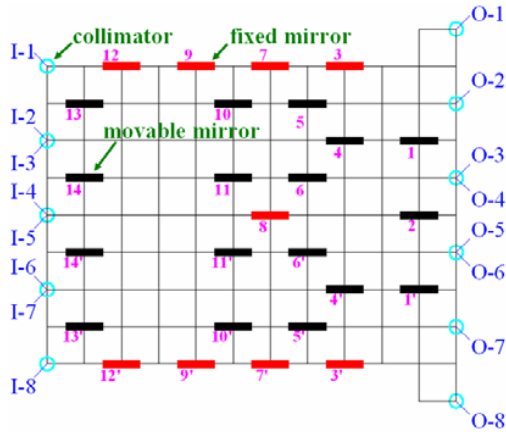

Fig. 15 Mirror numbers of the optical switch

TABLE IV
ROTATION OF MIRRORS

Mirror number	Rotation angle of mirror (degree)	
	70°C	-40°C
1	0.0030	0.0043
2	0.0019	0.0028
3	0.0100	0.0144
4	0.0058	0.0084
5	0.0064	0.0092
6	0.0035	0.0051
7	0.0019	0.0027
8	0.0023	0.0034
9	0.0087	0.0125
10	0.0104	0.0150
11	0.0002	0.0004
12	0.0079	0.0114
13	0.0054	0.0078
14	0.0231	0.0334

In all paths, the path from the third input fiber to the second output fiber is shown as Fig. 16 and it accumulates the maximum misalignment computed from the results. The total rotation of the path is 0.0634°, and it leads the optical misalignment of 0.1268°, which is larger than the allowable value of the collimators, 0.07°. Therefore, the signals of an 8x8 optical switch would be unstable.

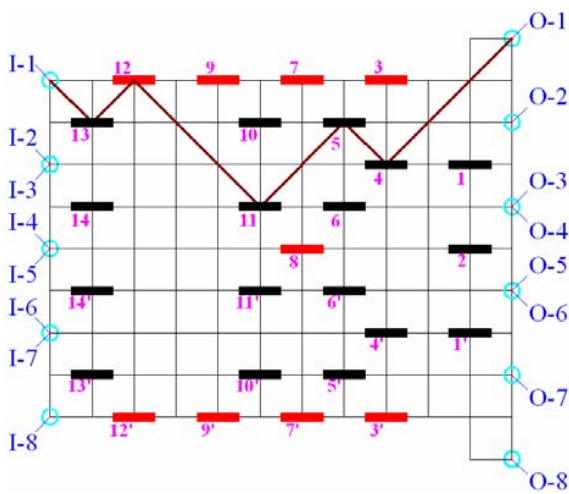

Fig. 16 An optical path with maximum misalignment

For stabilizing the transmission signals of 8x8 optical switches, an optimum problem is used by genetic algorithms (GA). The geometry of switch system is shown in Fig. 17. The objective function is to minimize the sum of all the mirror rotation angles in each optical path. There are two design variables; one is the thickness of base plate x_1 and another is the height of relay holders x_2 . The constraints are the thickness of base plate must be less than 7 mm and the height of relay holders must be less than 9 mm. Thus, the optimum problem is listed in Equation (9). The initial values of design variables are 6.5 mm and 4.5 mm, respectively. The optimum design problem is described in Equation (9).

Find \bar{x} , such that $\sum [\theta_i(\bar{x})]^2 \rightarrow \min$
subject to:

$$1 \leq x_1 \leq 6.5$$

$$1 \leq x_2 \leq 8.5$$

where $\theta_i(x)$ is the rotation of the i^{th} mirror in a optical path, which determines the signals of 8x8 optical switch would be stable or not. The relation between objective function and design variables is shown as Equation (2) to (8) and the rotation will be changed by the design variables.

The results of the optimum solution are $x_1 = 3.3144$ mm, $x_2 = 7.60094$ mm. The maximum mirror rotation (0.034°) of a critical light path is allowable. Therefore, the optimum design of this system can provide the better structure, of the optical switch that satisfies design specifications.

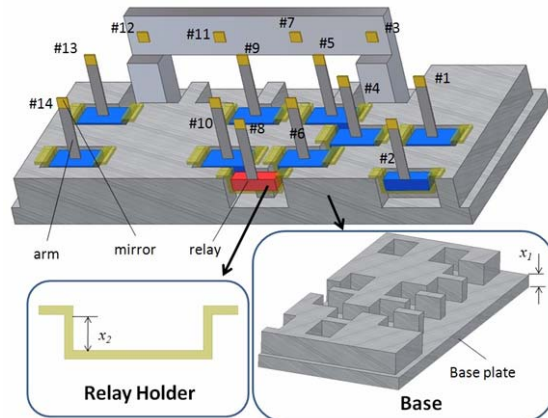

Fig. 17 The geometric structure of 8x8 optical switch

VI. CONCLUSION

In this paper, an 8x8 optical switch is proposed with fewer mirrors, and the optimum design is carried out to improve to the thermal characteristics. To improve the reliability, the thermal-compensated design is proposed to reduce the effects from thermal deformation. The design contains two design concepts to keep the mirrors' motions away from the sensitive directions. For the best performance, an optimum program is

carried out for minimizing the rotations of the 8x8 optical mirrors to reduce the optical loss. Therefore, the performance of the 8x8 optical switches is confirmed in satisfying design requirements.

REFERENCES

- [1] D. T. Neilson, R. Frahm, P. Kolodner, C. A. Bolle, R. Ryf, J. Kim, A. R. Papazian, C. J. Nuzman, A. Gasparyan, N. R. Basavanthally, V. A. Aksyuk and J. V. Gates, "256 256 Port optical cross-connect subsystem," *Journal of Lightwave Technology*, vol. 22, no. 6, pp.1499-1509, 2004.
- [2] X. C. Shan, T. Ikehara, Y. Murakoshi and R. Maeda, "Applications of micro hot embossing for optical switch formation," *Sensors and Actuators*, vol. 119, pp.433-440, 2004.
- [3] J. Bao, Z. Cao, Y. Yuan and X. Wu, "A non-silicon micro-machining based scalable fiber optic switch," *Sensors and Actuators*, vol. 116, pp. 209-214, 2004.
- [4] H. T. Hsieh, C. W. Chiu, T. Tsao, F. Jiang and G. D. J. Su, "Low-actuation-voltage MEMS for 2-D optical switches," *Journal of Lightwave Technology*, vol. 24, no.11, pp.4372-4379, 2006.
- [5] X. Li, Z. Zhou and M. Hamdi, "Non-violation set scheduling for two-dimensional optical MEMS switch," *IEEE Communications Letters*, vol. 10, no. 4, pp. 308-310, 2006.
- [6] X. H. Ma and G. S. Kuo, "A novel integrated multistage optical MEMS-mirror switch architecture design with shuffle Benes inter-stage connecting principle," *Optics Communications*, vol. 242, pp.179-189, 2004.
- [7] J. Q. Wang, S. C. Lin and J. S. Wu, "Method of mirror layout of multi-level optical switch," *Taiwan R.O.C. Patent No. 434418*, 2000.
- [8] W. W. Morey and W. L. Glomb, "Incorporated Bragg filter temperature compensated optical waveguide device," *U.S. Patent No. 5,042,898*, 1991.
- [9] G. W. Yoffe, P. A. Krug, F. Ouellette and D. A. Thorncarft, "Passive temperature-compensated package for optical fiber gratings," *Applied Optics*, vol. 34, pp.6859-6861, 1995.
- [10] L. G. de Peralta, A. A. Bernussi, V. Gorbounov and H. Temkin, "Temperature-insensitive reflective arrayed-waveguide grating multiplexers," *IEEE Photonics Technology Letter*, vol. 16, no. 3, pp.831-833, 2004.
- [11] D. L. Weidman, G. H. Beall, K. C. Chyung, G. L. Francis, R. A. Modavis and R. M. Morena, "A novel negative expansion substrate material for a themalizing fiber bragg gratings," *22nd European Conference on Optical Communication-ECOC'96, Oslo*, pp.1.61-1.63, 1996.
- [12] H. Tanobe, Y. Kondo, Y. Kadota, K. Okamoto and Y. Yoshikuni, "Temperature insensitive arrayed waveguide gratings on InP substrates," *IEEE Photonics Technology Letter*, vol. 10, no. 2, pp.831-833, 1998.
- [13] P. J. Lemaire and G. J. Shevchuk, "Fiber grating package," *U.S. Patent No. 5,841,920*, 1998.
- [14] T. T. Chung, C. T. Lin and H. Fan, "Design and analysis of a 8x8 optical switch," *The 12th International Conference on Mechatronics Technology(ICMT 2008)*, Sudbury, Ontario, Canada, 2008.

Tien-Tung Chung was born in Taoyuan, Taiwan, on September 16, 1953. He received his bachelor degree from Dept. of Power Mechanical Engineering of National Tsing Hua University, Hsinchu, Taiwan, in 1976. After his two years of military service, he got both of his master degree and Ph.D. degree from Dept. of Mechanical Engineering of National Taiwan University, Taipei, Taiwan, in 1980 and 1986, respectively.

He has been an associate professor in Dept. of Mechanical Engineering at National Taiwan University since August 1987. His research interests include structural optimization, computer-aided design, expert system and reverse engineering.