

# Optimization of Proton Exchange Membrane Fuel Cell Parameters Based on Modified Particle Swarm Algorithms

M. Dezvarei, S. Morovati

**Abstract**—In recent years, increasing usage of electrical energy provides a widespread field for investigating new methods to produce clean electricity with high reliability and cost management. Fuel cells are new clean generations to make electricity and thermal energy together with high performance and no environmental pollution. According to the expansion of fuel cell usage in different industrial networks, the identification and optimization of its parameters is really significant. This paper presents optimization of a proton exchange membrane fuel cell (PEMFC) parameters based on modified particle swarm optimization with real valued mutation (RVM) and clonal algorithms. Mathematical equations of this type of fuel cell are presented as the main model structure in the optimization process. Optimized parameters based on clonal and RVM algorithms are compared with the desired values in the presence and absence of measurement noise. This paper shows that these methods can improve the performance of traditional optimization methods. Simulation results are employed to analyze and compare the performance of these methodologies in order to optimize the proton exchange membrane fuel cell parameters.

**Keywords**—Clonal algorithm, proton exchange membrane fuel cell, particle swarm optimization, real valued mutation.

## I. INTRODUCTION

NOWADAYS, by increasing usage of electricity energy in different industrial field, using from clean and new generation of electricity product is really important. In order to have a clean electricity energy without pollution and getting high performance with a good reliability, the traditional electricity energy production methods are replaced with several new methods. Among these methods, fuel cells are new and clean generation that can produce electricity and thermal energy to use in various industrial usages.

The usage of fuel cell makes a wide research gate for the researchers and investigators to find the best methods and optimization of fuel cell parameters to get the best performance. Among the optimization methods, particle swarm optimization algorithm (PSO) is a kind of high performance optimization algorithm.

In recent years, several different researches have been done in this field. PSO algorithm has been introduced as an effective technic for identifying some PEMFC parameters in [1]. Simulation results and desired values have been compared

to confirm the performance of this method. In [2], an electrical equivalent circuit of PEMFC has been presented. This paper expressed a model with an accurate representation of the static and dynamic behavior for the PEMFC. The main work in this paper was the application of the simulated annealing as an optimization method to get the PEMFC model parameters. Reference [3] described a modified PSO algorithm by using a RVM operator in order to enhance the global search capacity. This modified algorithm of PSO, has been investigated along with PSO variants and the results showed that effectiveness of RVM has been varied for different PSO variants as well as different kinds of functions. In [4], a new PSO method based on clonal selection algorithm has been proposed to guarantee the diversity of the population and avoiding premature convergence. Experimental results show the effective performance of this method as well. Reference [5] proposed a novel PSO algorithm based on immunity clonal strategies as a clonal PSO. It has been found that this method has better optimization solving capability and faster convergence than the conventional standard PSO based on the simulation results.

In this paper, at first by describing the equivalent circuit of the PEMFC, electrochemical reactions and relevant equation are presented. PSO algorithms are described generally and two types of modified PSO algorithm as a clonal selection algorithm and RVM algorithm are investigated to optimized the PEMFC parameters. Simulation results are employed to show the effectiveness of these methods by comparing the optimized parameters with the original value of the PEMFC in the presence and absence of measurement noise.

## II. PEMFC MODELING

In this section, electrical equivalent circuit model of a PEMFC and its equations are presented. The electrochemical reactions in the PEMFC process can be described as:

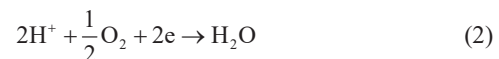

Therefore, the overall reaction can be defined as:



M. Dezvarei is with the Imam Khomeini International University, School of Electrical Engineering, Qazvin, Iran (e-mail: dezvarei.m@gmail.com).

S. Morovati is with Iran University of Science and Technology, School of Railway Engineering, Tehran, Iran (e-mail: s\_morovati@rail.iust.ac.ir).

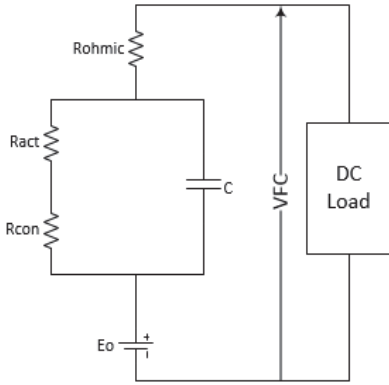

Fig. 1 Electrical equivalent circuit of a fuel cell

As shown in Fig. 1, (4)-(7) can represent the static fuel cell stack electrochemical behavior for a single cell of the PEMFC.

$$V_{FC} = E_0 - \eta_{ohmic} - \eta_{act} - \eta_{con} \quad (4)$$

$$\eta_{ohmic} = r \times i \quad (5)$$

$$\eta_{act} = A \ln\left(\frac{i}{i_0}\right) \quad (6)$$

$$\eta_{con} = -B \ln\left(1 - \frac{i}{i_L}\right) \quad (7)$$

where, in (4),  $E_0$  is the open circuit voltage, and  $\eta_{ohmic}$  is the resistance loss resulting from electrolyte resistance to the flow of electrons. The activation over potential as the  $\eta_{act}$ , is due to the activating chemical reactions to take place at the fuel cell electrodes.  $\eta_{con}$  is the voltage drop because of the consumptions of reactants by the fuel cell.

In (5),  $r$  is the area specific resistance, and  $i$  is the fuel cell current rating.  $A$  and  $i_0$  are the Tafel slope and the exchange current density in (6), respectively. In (7),  $B$  is used as the concentration constant, and  $i_L$  is the limiting current density for which the fuel cell is being used at the same rate in the maximum supply speed. Then, we can simplify (4) as:

$$V_{FC} = E_0 - r(i + i_n) - A \ln\left(\frac{i + i_n}{i_0}\right) + B \ln\left(1 - \frac{i + i_n}{i_L}\right) \quad (8)$$

$i_n$  is used in this equation because of the other losses due to the internal current in the fuel cell.

It could be found that parameters of the fuel cell can be simplified to optimize the six parameters in (8) ( $E_0, i_n, i_0, A, B, r$ ). In order to have more than one cell, the overall voltage of fuel cell stack can be calculated as (9) where  $Z$  is the number of fuel cell connected together in series:

$$V_T = ZV_{FC} \quad (9)$$

The general equation of the fuel cell can be rewritten as (10):

$$f(V_s, i, \Delta) = V_s - Z(E_0 - r(i + i_n) - A \ln\left(\frac{i + i_n}{i_0}\right) + B \ln\left(1 - \frac{i + i_n}{i_L}\right)) \quad (10)$$

where  $\Delta$  is a set of identified parameters ( $E_0, i_n, i_0, A, B, r$ ) of the fuel cell model. In parameters identification of the fuel cell, we need an objective function which is considered based on root mean square deviation (RMSD) model which is one of the best methods to show differences between the original and simulated data. This objective function can be defined as:

$$F = \sqrt{\frac{1}{N} \sum_{k=1}^N f(V_s(K), i(k), \Delta)^2} \quad (11)$$

By minimizing (11), the best value of simulated parameters will be achieved.

### III. PARTICLE SWARM OPTIMIZATION (PSO) ALGORITHM

PSO is a population based optimization algorithm inspired by social behavior of animals like school of fishes or bird flocking. The PSO algorithm uses from the natural intelligence of particles in such that a number of particles look for the best state in multidimensional space of their swarm. During flight or swim, each particle adjusts its position according to its experience and neighbors' experiences, including current velocity, position, and the best previous position. At this time, all particles will be reached to their best positions.

The PSO algorithm starts from the random solution of particle position and velocity which does not have any effect on optimization process. Then, searching for the best state by updating themselves will begin. Particles profit from the neighbor experience to get its best state. Each particle keeps tracking of its coordination in the solution space which is associated with the best solution (fitness) that has achieved by that particle before.

The basic concept of PSO is movement of each particle toward its personal best position which is called pbest and the global best position as the gbest, with a random weighted acceleration at each time. In the other words, PSO utilizes pbest and gbest to modify the current search point to avoid the particle movement in the same direction, meanwhile the swarm will converge to optimal position. Position of particle is corresponding to set of PEMFC model parameter which is considered to solution point in search space.

The position and velocity of each particle calculates based on linear combination of position and velocity vector as following (12)-(13), respectively:

$$x_j(t+1) = v_j(t+1) + x_j(t) \quad (12)$$

$$v_j(t+1) = w(t)v_j(t) + c_1r_{1j}(t)(pbest_j(t) - x_j(t)) + c_2r_{2j}(t)(gbest(t) - x_j(t)) \quad (13)$$

where  $j$  represents particle number,  $x$  and  $v$  are position and velocity of each particle, respectively,  $r_1$  and  $r_2$  are random numbers between zero and one. The different random numbers are used in each dimension of all particles.  $C_1$  and  $C_2$  are cognitive and social parameters (learning factor), and  $w$  is an inertia weight which is used to control the balance between exploration and exploitation (global and local search) based on linear decreasing as:

$$w(t) = w_{\max} - (w_{\max} - w_{\min}) \frac{t}{t_{\max}} \quad (14)$$

where  $w_{\max}$  and  $w_{\min}$  are initial and final inertia, and  $t$  is the iteration number.

To identify the PEMFC parameters, the fitness function is (11), and the objective function minimization will be done with the aim of optimization process.

Firstly, all particles are initialized randomly, and their fitness is evaluated according to the proposed objective function.

The personal best position (pbest) of particles is calculated based on comparison with the current and best position as (15):

$$pbest_j(t) = \begin{cases} pbest_j(t-1), & \text{if } X_j(t) \geq (Fpbest_j(t-1)) \\ X_j(t), & \text{if } X_j(t) < (Fpbest_j(t-1)) \end{cases} \quad (15)$$

The global best position of particles (gbest) is the best minimum value of personal particles position in each iteration that can be defined as:

$$gbest(t) \in (pbest_1(t), pbest_2(t), \dots, pbest_N(t)) \\ |F(gbest(t)) = \min \{F(pbest_1(t), \dots, pbest_N(t))\} \quad (16)$$

The velocity of particles can be rewritten as (17) and to clamp the excessive roaming of particle, velocity shall be limited between  $[-v_{\max}, v_{\max}]$ .

$$v_j(t+1) = \begin{cases} v_{\max}, & \text{if } v_j(t+1) > v_{\max} \\ -v_{\max}, & \text{if } v_j(t+1) < -v_{\max} \\ v_j(t+1), & \text{Otherwise} \end{cases} \quad (17)$$

The  $v_{\max}$  value is related to the maximum allowable excursion of any particle in that dimension [1].

The algorithm stop point is specified based on the maximum iteration value ( $t_{\max}$ ) or the minimum fitness of objective function. In this paper, the maximum iteration is

considered as the stop point.

The PSO algorithm procedure is shown in Fig. 2.

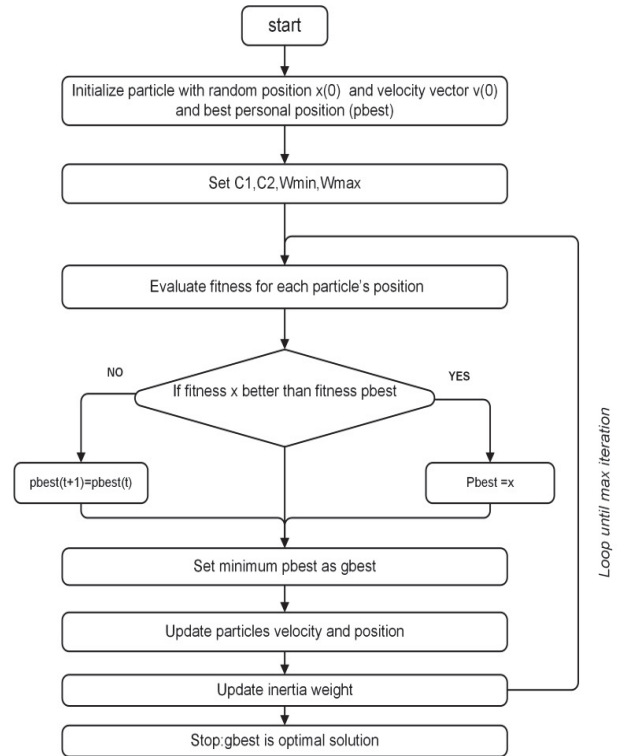

Fig. 2 PSO algorithm flowchart

Simulation parameters which are used in the optimization process by using MATLAB software are given in Table I.

TABLE I  
SIMULATION PARAMETERS

parameter	definition	value
$C_1$	Learning Factor	2
$C_2$	Learning Factor	2
$t_{\max}$	Maximum Iteration	20000
$w_{\max}$	Final Inertia Weight	0.9
$w_{\min}$	Initial Inertia Weight	0.4

#### IV. CLONAL OPTIMIZATION ALGORITHM

In this part, the clonal PSO algorithm (CPSO) which is based on human immune system is presented. When human body faces with antibodies, the body immune system generates several types of antigens to defeat against antibodies. But, one of them has a significant effect to remove antibodies. Finally, the immune system clones the compatible antigen as the best solution against antibodies. This proliferation causes to increase the chance of antibody elimination and to decrease time of immune system response.

In general, PSO algorithm updating the velocity of each particle is done by the knowledge of its past velocity, personal and global best positions. Therefore, when the global best position is the best choice among all the personal best

positions, using the updated velocity has a bit contribution in the moving them to new positions [6]. Meanwhile, in the CPSO method when the initial position of each particle is represented, after every positional search, all of the particles move to the global best position at which each particle disperses according to the gain and direction of its velocity. This process will be repeated until the best global position can represent the optimal solution of the problem. Updating equations by using CPSO algorithm can be defined as:

$$v'_j(t+1) = w(t) \times v'_j(t) \tag{18}$$

$$x'_j(t+1) = v'_j(t+1) + x'_j(t) \tag{19}$$

As noisy data are a popular disturbance in measuring and are used in order to check the robustness of CPSO when a specified noise level is added in measured voltage output of PEMFC, the noisy voltage data are calculated as:

$$V_{noisy} = V_{noise\ free} (1 + level \times random) \tag{20}$$

where,  $V_{noise\ free}$  is the original voltage value, random is a number between  $[-1, +1]$ , and the level noise for PEMFC voltage is assumed 1%.

The simulation results of the CPSO algorithm with/ without noisy data are shown in Fig. 3. As it shown in this figure, it can be found that using CPSO algorithm can improve the optimization process costly and it has a high performance in tracking the original data even in the presence of noise.

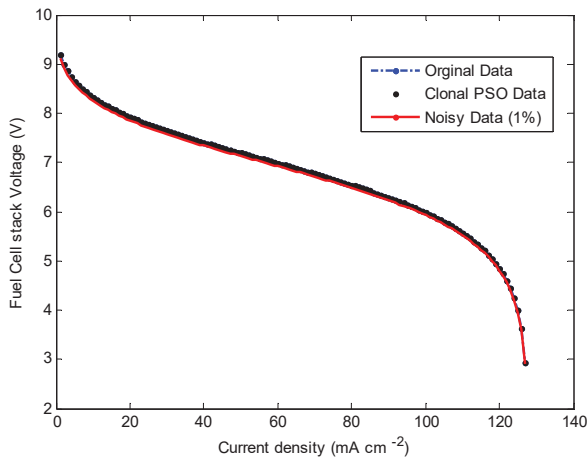

Fig. 3 Voltage-current curves

In Figs. 4 and 5, convergence process for the objective function is shown. As can be seen, it can be concluded that even in the presence of measurement noise, CPSO algorithm has a worthy performance in the optimization process.

In order to compare the results of the optimized parameters, the real value parameters of the PEMFC and simulation results are given in Table II.

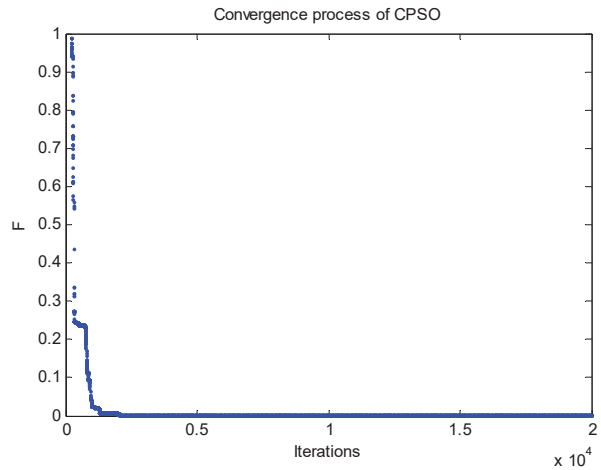

Fig. 4 Convergence process of CPSO

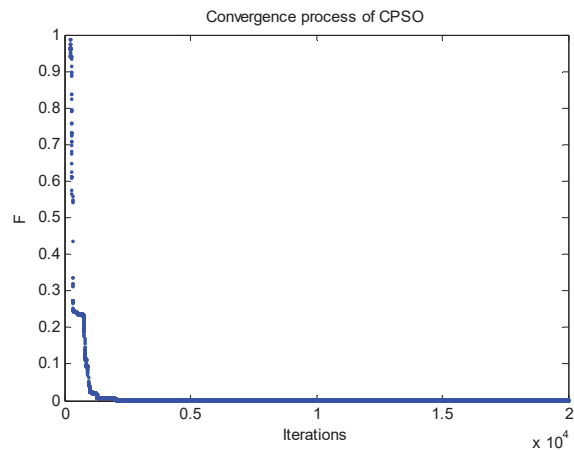

Fig. 5 Convergence process of CPSO with noisy data

TABLE II  
SIMULATION RESULTS BY CPSO

parameter	Real value	Simulated data	
		Free noise	Noisy data
$E_o$ (V)	1.04	0.96143	0.95838
A (V)	0.05	0.05000	0.04954
$i_n$ (mA cm <sup>-2</sup> )	1.26	1.26036	1.26036
$i_o$ (mA cm <sup>-2</sup> )	0.21	1.01091	0.89929
r (kΩ cm <sup>2</sup> )	0.000098	0.000098	0.000097
B (V)	0.08	0.07999	0.07925
F (N/A)	N/A	$2.85 \times 10^{-5}$	$2.88 \times 10^{-5}$

V.RVM OPTIMIZATION ALGORITHM

In this section, RVM algorithm is presented as a modified and advancement of PSO algorithm. This method is applied in the PSO method to increase the diversity of particles in global search. The RVM is based on mutation of particle position caused to find global position with more precise possibility and to avoid for local minimum problem which is more popular in optimization methods. As it can be inferred from the mutation meaning, the selected particle in population shall

be mutated to expand the search area to find global best position. Suppose that  $j$ th particle ( $x_j$ ) is a chosen particle for mutation and for each part of particle defines a sequence of decimal digits as (21):

$$s_{ji} = d_{ji}^1 d_{ji}^2 \dots d_{ji}^{P_{ji}} \quad (21)$$

where  $i$  represents the particle components, and  $P_{ji}$  denotes the number of digits in  $x_{ji}$  including all number parts and the first four digits in the decimal part (excluding the decimal point) [3].

By the concept of mutation in natural genetic, mutation phase is done with converting small digits into a big one and vice versa. This means that the position of mutated particle changes completely. In mutation step, some components of selected particle are randomly chosen to convert digits so that a random binary sequence with size of  $P_{ji}$  is generated and compared to the selected particle. If  $r$ th of binary sequence is one, then  $r$ th of  $S_{ji}$  will mutate. After any mutation, the decimal digit sequence becomes:

$$\overline{s}_{ji} = \overline{d}_{ji}^1 \overline{d}_{ji}^2 \dots \overline{d}_{ji}^{P_{ji}} \quad (22)$$

where,

$$\overline{d}_{ji}^r = \begin{cases} 9 - d_{ji}^r & \text{Mutate} \\ d_{ji}^r & \text{Otherwise} \end{cases} \quad (23)$$

After that, the position and velocity of selected particles will be updated in PSO procedure to use in the next iteration.

In the PSO-RVM algorithm, the first step is initializing and setting the parameters including PEMFC and optimization algorithm.

In this paper, the original values of PEMFC parameters are identified according to [1], and  $P_m=0.05$  is the mutation rate which is used to determine the number of selected particles in the mutation process [7]. The effectiveness of the proposed algorithm is evaluated by the shape fitted curve of voltage-current with the curve of original values. Optimization process includes initializing the first position, velocity, pbest, and gbest for all particles in the first state. These values are initialized randomly, and the purposed algorithm is free from the initial state of particle.

After initializing the first state of particle and setting optimization constant and parameters, the proposed PSO-RVM algorithm will be executed based on the modified PSO procedure and regarding to mutation phase until the algorithm reaches to the maximum iteration.

The noise level and its equation have been considered the same as (20) in the CPSO method.

The simulation parameters are given in Table III to compare them with the original data in the presence and absence of measurement noise.

TABLE III  
SIMULATION RESULTS BY PSO-RVM

parameter	Real value	Simulated data	
		Free noise	Noisy data
$E_o$ (V)	1.04	0.97037	0.96053
$A$ (V)	0.05	0.04999	0.04992
$i_n$ (mA cm <sup>-2</sup> )	1.26	1.25973	1.25987
$i_o$ (mA cm <sup>-2</sup> )	0.21	0.84513	0.99957
$r$ (kΩ cm <sup>2</sup> )	0.000098	0.000098	0.000098
$B$ (V)	0.08	0.08000	0.07988
$F$ (N/A)	N / A	$1.23 \times 10^{-5}$	$2.49 \times 10^{-5}$

The voltage-current curve of PEMFC based on original data and PSO-RVM method is shown in Fig. 6. Actually, the PSO-RVM method increases the chance for finding the best solution by adding some fresh particles with the mutation characteristics in each fly or moving steps. It can be seen that the optimized parameters in the presence or the absence of noise are close to the real values, and the voltage curve based on current density of the fuel cell in the both conditions has a good accuracy and fitness with the real curve.

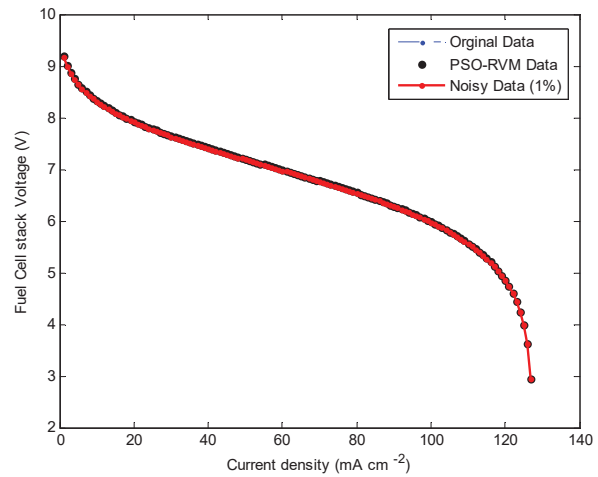

Fig. 6 Voltage-current curves

In Figs. 7 and 8, the convergence process of the cost function is shown. As it is seen, it can be concluded that, even in the presence of measurement noise, the PSO-RVM algorithm has a good performance in the optimization process.

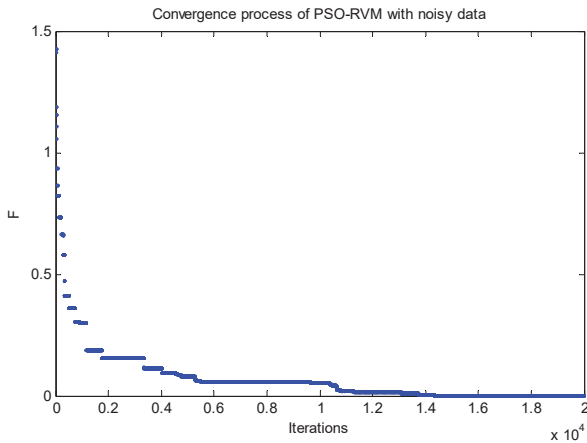

Fig. 7 Convergence process of PSO-RVM

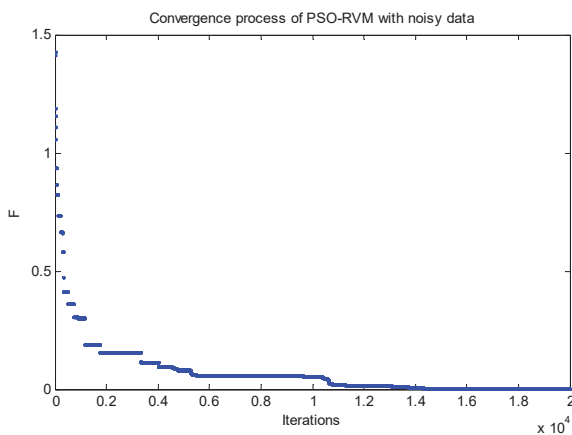

Fig. 8 Convergence process of PSO-RVM with noisy data

## VI. CONCLUSION

In this paper, we presented the modified PSO algorithms as CPSO and RVM algorithms to have a better optimization process for the PEMFC parameters. By comparing the simulation results, it could be found that these methods can improve the optimization costly even in the presence of measurement noise. Generally, the optimization of different objective functions is really significant, and using new methods can be useful in the optimization process with a good accuracy and high performance.

## REFERENCES

- [1] M. Ye, X. Wang, Y. Xu, "Parameter identification for proton exchange membrane fuel cell model using particle swarm optimization," *International journal of hydrogen energy*, 2008.
- [2] M-T. Outeiro, R. Chibante, A. S. Carvalho, A. T. de Almeida, "A parameter optimized model of a proton exchange membrane fuel cell include temperature effects", *International journal of power sources*, 2008.
- [3] H. Lu, P. Striyanyong, Y. Hua Song, T. Dillon, "Experimental study of a new hybrid PSO with mutation for economic dispatch with non-smooth cost function", *International journal of electrical power and energy system*, 2010.2010.
- [4] L. Hu, "A novel particle swarm optimization method using clonal selection algorithm", *International Conference on Measuring Technology and Mechatronics Automation*, 2009.
- [5] Y. Tan, Z. M. Xiao, "Clonal particle swarm optimization and its applications", *IEEE Congress on Evolutionary Computation*, 2007.
- [6] S. J. Nanda, G. Panda, B. Majhi, "Improved identification of Hammerstein plants using new CPSO and ISPO algorithms", *Journal of Expert Systems with Applications*, 2010.
- [7] N. Higashi, H. Iba, "Particle swarm optimization with Gaussian mutation", *Proceeding of the IEEE swarm intelligence symposium*, 2003.