

# Optimization of Loudspeaker Part Design Parameters by Air Viscosity Damping Effect

Yue Hu, Xilu Zhao, Takao Yamaguchi, Manabu Sasajima, Yoshio Koike, Akira Hara

**Abstract**—This study optimized the design parameters of a cone loudspeaker as an example of high flexibility of the product design. We developed an acoustic analysis software program that considers the impact of damping caused by air viscosity. In sound reproduction, it is difficult to optimize each parameter of the loudspeaker design. To overcome the limitation of the design problem in practice, this study presents an acoustic analysis algorithm to optimize the design parameters of the loudspeaker. The material character of cone paper and the loudspeaker edge were the design parameters, and the vibration displacement of the cone paper was the objective function. The results of the analysis showed that the design had high accuracy as compared to the predicted value. These results suggested that although the parameter design is difficult, with experience and intuition, the design can be performed easily using the optimized design found with the acoustic analysis software.

**Keywords**—Air viscosity, design parameters, loudspeaker, optimization.

## I. INTRODUCTION

CONE dynamic loudspeakers came into use in the 1930s and currently are the most widely used loudspeakers. The vibration analysis of conical loudspeakers was first reported in the 1940s by Brown [1] and Bordoïn [2], who studied sound radiation using a loudspeaker cone as a rigid body. However, the rigid body model of a cone is only effective in the case of low-range piston vibration. In 1951, Nimura et al. [3] performed a theoretical analysis of the vibration of a loudspeaker cone. In this study, the eigenvalue of the vibration of a loudspeaker cone was calculated by a graphic solution. In 1975, Frankfort [4] obtained a solution to the membrane vibration of a conical cone, established an exact differential equation that considered flexural vibration, and performed detailed calculations of sound pressure frequency properties, vibration patterns, and driving-point admittance. However, Frankfort's analysis did not include calculations of the edge and center cap, which play important roles in conical loudspeakers. In the 1970s and 1980s, several vibration analyses of loudspeaker cones were performed using the finite element method (FEM) [5], [6]. The FEM has also emerged as an important technique for loudspeaker vibration analysis and

design. In 2005, Kyouno et al. performed an acoustic radiation analysis of loudspeakers by considering electrical, mechanical, and acoustic coupling problems [7]. The study demonstrated the usefulness of addressing a mechanical system and an acoustic system as a coupled problem.

Much research on loudspeaker vibration analysis has been conducted. Very few designs, however, employ optimization techniques. In 1978, Nomura et al. designed a phase inversion loudspeaker system using a nonlinear optimization method [8]. In 1979, Kusudo performed optimal loudspeaker design using the FEM and nonlinear optimization method [9].

This paper concerns a study of optimal materials for vibrating parts of conical loudspeakers. The research involved optimization analysis of vibration displacement of loudspeaker diaphragms using physical properties of vibrating parts of loudspeaker systems as design parameters. It also involved acoustic analysis of conical loudspeakers using acoustic analysis software [10] that takes the impact of dampening by air viscosity into account.

## II. RESPONSE SURFACE OPTIMIZATION METHOD

Optimization problems generally consist of the following three elements. These are referred to as the “three elements of optimization problems.”

- 1) “Design variables” are parameters that can be adjusted within a certain range during design. They are expressed by vectors having multiple components.
- 2) “Objective functions” are numerical values for evaluating targets of optimization, and are expressed as functions of design variables.
- 3) “Constraints” are conditions that must be satisfied during design regardless of circumstances. They are expressed as function inequalities among multiple design variables [11], [12].

Optimization problems are expressed by:

$$\text{Find } x = \{x_1, x_2, \dots, x_n\}^T,$$

$$\text{Min } W = f(x),$$

$$\text{S.T. } \underline{x}_i \leq x_i \leq \overline{x}_i \quad i = 1, 2, \dots, n.$$

Here, design variables include physical properties such as Young's modulus and density for loudspeaker part materials. The objective function is the vibration displacement of the loudspeaker diaphragm. Sound pressure level is a constraint.

Y. Hu, M. Sasajima, Y. Koike and A. Hara are with the Strategic Research & Development Division, Foster Electric Co., Ltd., 196-8550, 1-1-109 Tsutsujigaoka, Akishima, Tokyo, Japan (phone: 042-847-3334; e-mail: {thuy, sasajima, koike}@foster.co.jp).

X. Zhao is with the Department of Mechanical Engineering, Saitama Institute of Technology University, 369-0293, 1690 Fusaiji Fukaya Saitama, Japan (e-mail: zhaoxilu@sit.ac.jp).

T. Yamaguchi is with the Department of Mechanical Science and Technology Faculty of Science and Technology, Gunma University, 376-8515, 1-5-1 Tenjin-cho, Kiryu, Gunma, Japan (e-mail: yamagme3@gunma-u.ac.jp)

Optimization tool and analysis solver were calculated separately, as shown in Fig. 1 to provide high versatility.

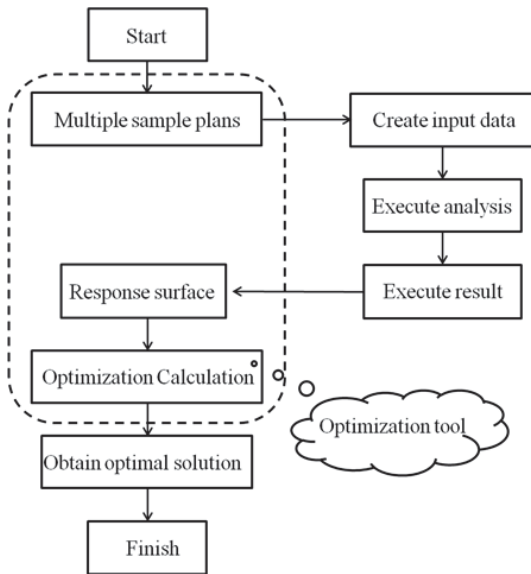

Fig. 1 Flowchart of the analysis solver outside the optimization software

The following calculation procedure is referred to when optimizing physical properties of loudspeaker parts using the response surface method. First, sampling data are prepared for optimization of the response surface method. Next, physical properties of each part are varied using sampling data. Loudspeaker vibration analysis is then conducted and Young's modulus and density to be used for the optimization calculation are obtained from the results of the analysis. Finally, the one-to-one relationships between sampling data and each characteristic value are put together and an interpolation/approximation formula for calculating response surface is prepared. The optimal solution is then determined by optimization calculation using the approximate calculation formula created.

### III. OPTIMIZATION OF LOUSPEAKER PART PHYSICAL PROPERTIES

#### A. Optimal Design Employing Physical Properties of Loudspeaker Cone Paper

This study is concerned with determining the optimal solution for determining vibration displacement of the loudspeaker diaphragm using physical properties of vibrating loudspeaker parts as design parameters.

Fig. 2 shows the loudspeaker model used for the studies described in this paper. First, the objective function is the vibration displacement of the loudspeaker diaphragm. The dotted line in Fig. 3 represents the analysis results for the loudspeaker diaphragm vibration displacement. The solid line

represents the objective function, vibration displacement of the loudspeaker diaphragm. Loudspeaker diaphragms are ideally supposed to exhibit piston motion at all times. Sound is also supposed to diminish by 6 dB each time the distance from the sound source is doubled. The design variables are density of loudspeaker cone paper and Young's modulus. The constraint is that sound pressure level must be maintained.

Table I gives the sampling data generated using design variables and their upper and lower limit values. Because cones employ materials such as paper and metal, Group A considers a wide range of material properties from paper pulp to metal. Various analyses were conducted using the sampling data obtained. Fig. 4 shows the results of the analyses.

Table II gives the optimization results obtained by creating a response surface using results of the analyses. Whereas all of the initial values in the table were center points for the modification range, optimal values varied according to design variables; diaphragm density was the threshold value. Fig. 5 shows the response surface. Fig. 6 shows the results of vibration analysis using the optimal solution obtained. The graph shows that the peak in characteristics that appears at 1500 Hz and 3000 Hz and the dip that appears at 2500 Hz are more even than those of the analysis results. The characteristics were confirmed to be even across the entire frequency band. The target for minimization of displacement is zero; thus, the result for Group A was 0.013. Fig. 7 shows the mode of vibration displacement for a standard loudspeaker at 1500 Hz. Fig. 8 shows the mode of vibration displacement for the optimal solution at 1500 Hz.

In the case of standard loudspeakers, the cone paper resonates and bends when it moves. In the case of the optimal solution, the loudspeakers were confirmed to move as a unit with uniform displacement.

Commonly used paper pulp was the focus for Group B. The optimization results obtained are given in Table III. Density of the diaphragm was the threshold value in Table III as well. The response surface is shown in Fig. 9. Fig. 10 shows the results of the vibration analysis using the optimal solution obtained. The diaphragm resonated at 2400 Hz. The target for minimization of displacement is zero; thus, the result for Group B was 0.02.

TABLE I  
SAMPLE DATA

No	Mass density (g/cm <sup>3</sup> )	Young's modulus (GPa)
1	0.2	1.67
2	2.51	1.67
3	5.0	1.67
4	0.2	35.8
5	2.51	35.8
6	5.0	35.8
7	0.2	70
8	2.51	70
9	5.0	70

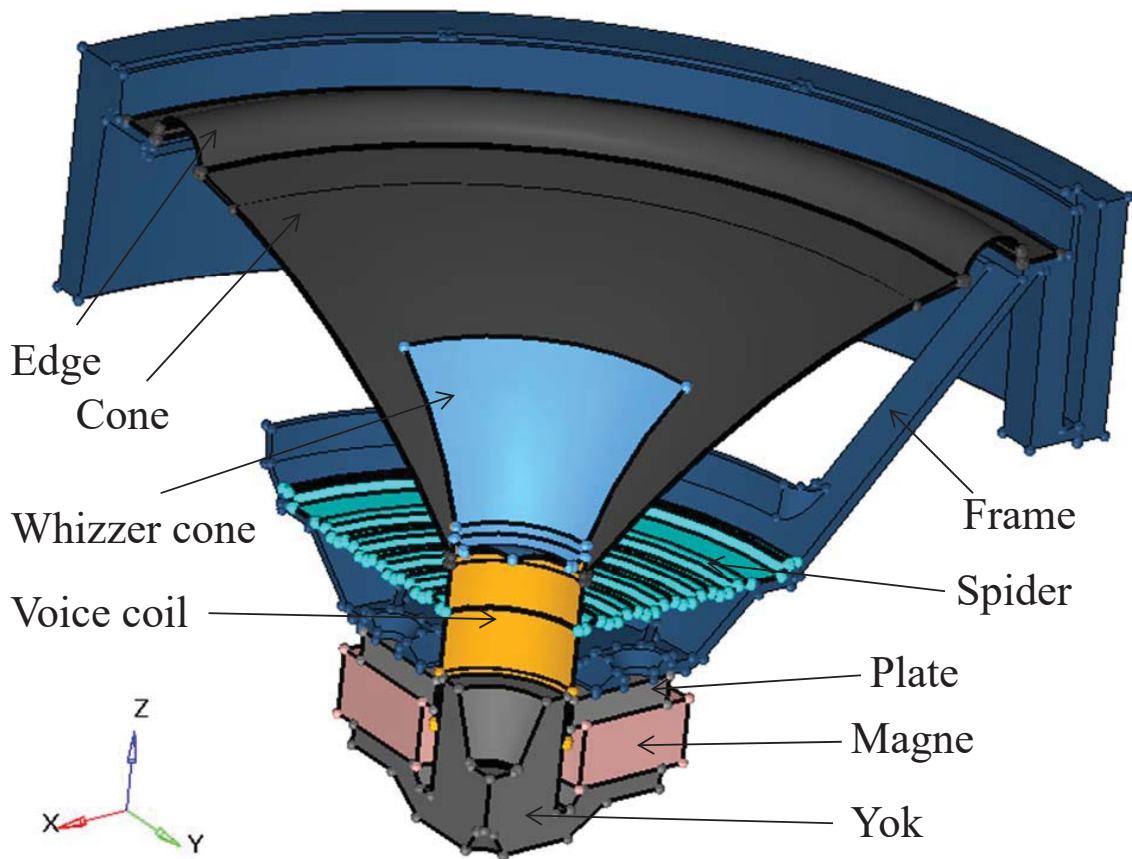

Fig. 2 One-fourth model of a loudspeaker

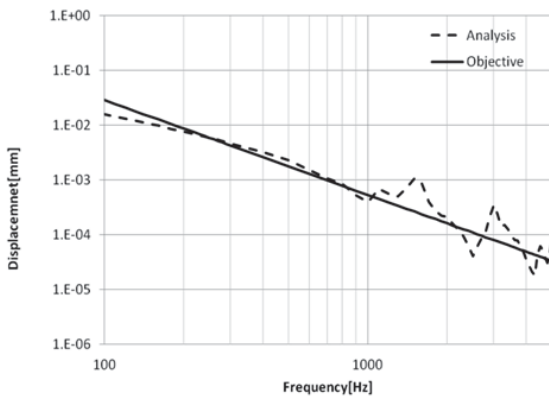

Fig. 3 Diaphragm vibration displacement analysis values and objective function

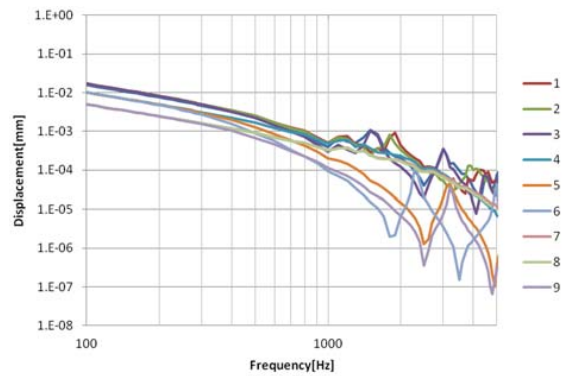

Fig. 4 Analysis results of nine data samples

TABLE II  
DESIGN VARIABLES OF OPTIMIZATION

	Lower limit value	Upper limit value	Initial value	Optimal value
Cone Young's modulus	1.67	70	35.835	32.28
Cone Mass density	0.2	5	2.6	0.2

TABLE III  
DESIGN VARIABLES OF OPTIMIZATION

	Lower limit value	Upper limit value	Initial value	Optimal value
Cone Young's modulus	0.5	7	3.75	2.8
Cone Mass density	0.1	1	0.55	0.1

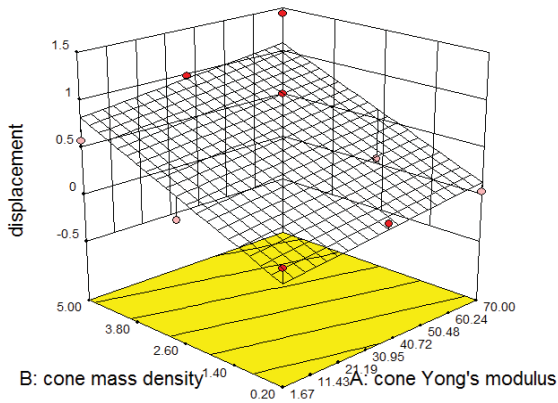

Fig. 5 Response surface of Group A

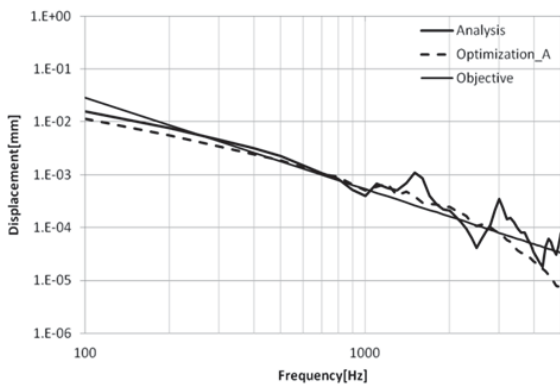

Fig. 6 Analysis results of Optimal Solution A

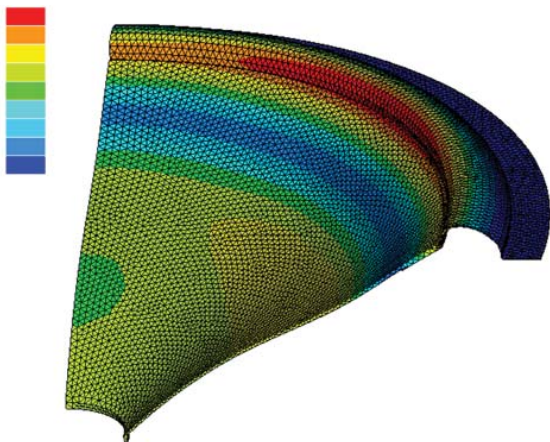

Fig. 7 Mode of vibration displacement for the standard loudspeaker at 1500 Hz

*B. Optimal Design Employing Physical Properties of Loudspeaker Diaphragm*

Density and Young's modulus were taken into account for the cone only in the section above. Young's modulus and density of edge as well are taken into account here. They are four design variables. It is Group C. The objective function and constraints are the same. Table IV gives the sampling data generated using design variables and their upper and lower

limit values. Various analyses were conducted using the sampling data obtained.

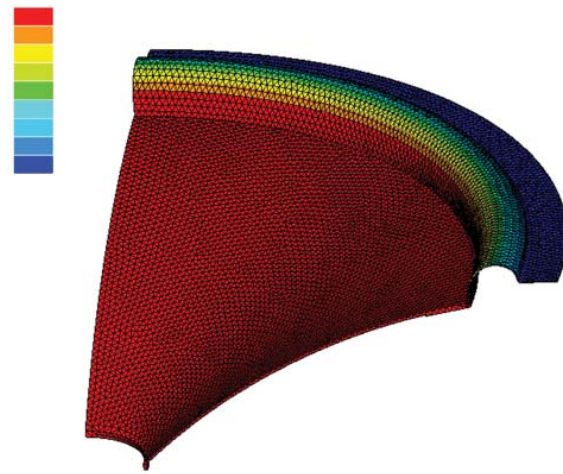

Fig. 8 Mode of vibration displacement for Optimal Solution A at 1500 Hz

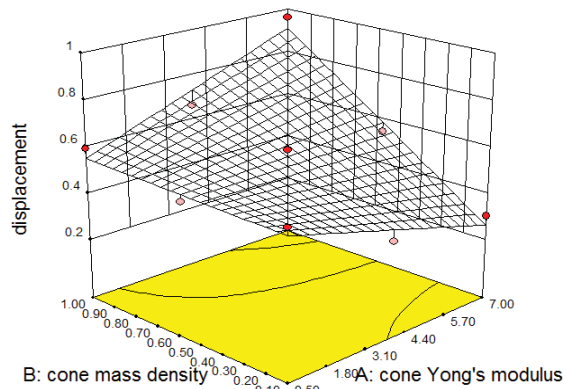

Fig. 9 Response surface of Group B

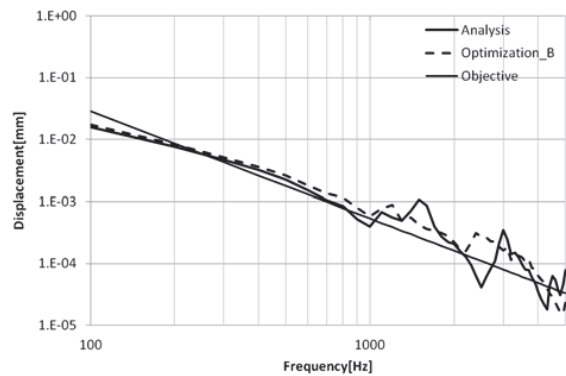

Fig. 10 Analysis results of Optimal Solution B

TABLE IV  
SAMPLE DATA

No	CONE Mass density (g/cm <sup>3</sup> )	CONE Young's modulus (GPa)	Edge Mass density (g/cm <sup>3</sup> )	Edge Young's modulus (GPa)
1	0.35	0.73	0.3	0.032
2	0.35	0.73	0.3	0.116
3	0.35	0.73	0.3	0.2
4	0.775	0.73	0.8	0.032
5	0.775	0.73	0.8	0.116
6	0.775	0.73	0.8	0.2
7	1.2	0.73	1.3	0.032
8	1.2	0.73	1.3	0.116
9	1.2	0.73	1.3	0.2
10	0.35	3.865	0.8	0.032
11	0.35	3.865	0.8	0.116
12	0.35	3.865	0.8	0.2
13	0.775	3.865	1.3	0.032
14	0.775	3.865	1.3	0.116
15	0.775	3.865	1.3	0.2
16	1.2	3.865	0.3	0.032
17	1.2	3.865	0.3	0.116
18	1.2	3.865	0.3	0.2
19	0.35	7	1.3	0.032
20	0.35	7	1.3	0.116
21	0.35	7	1.3	0.2
22	0.775	7	0.3	0.032
23	0.775	7	0.3	0.116
24	0.775	7	0.3	0.2
25	1.2	7	0.8	0.032
26	1.2	7	0.8	0.116
27	1.2	7	0.8	0.2

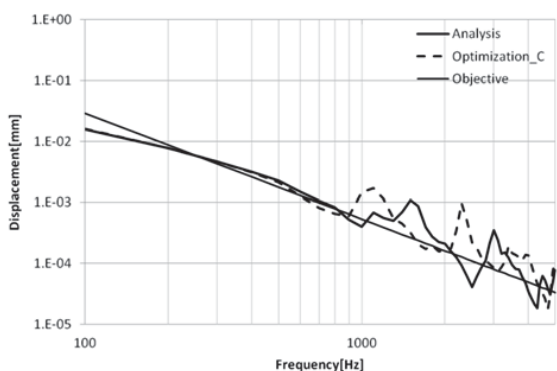

Fig. 11 Analysis results of Optimal Solution C

The optimal solution was obtained as follows: Young's modulus for the cone is 0.73 GPa, the mass density of the cone is 0.35 g/cm<sup>3</sup>, Young's modulus for the edge is 0.032 GPa, edge's mass density is 0.38 g/cm<sup>3</sup>. Fig. 11 shows the results of vibration analysis using the optimal solution obtained. The graph shows that the peak in characteristics that appears at 1500 Hz and 3000 Hz and the dip that appears at 2500 Hz are smaller than those of the analysis results. The new diaphragm resonated at 110 Hz and 2400 Hz. The target for minimization of displacement is zero; thus, the result for Group C was 0.019.

IV. DISCUSSION

This research is concerned with determining the optimal solution for vibration displacement of the loudspeaker diaphragm using physical properties of the vibrating loudspeaker parts as design parameters. First, Young's modulus and the density of the loudspeaker cone paper were studied, and optimal solution was determined. Next, attention was turned to the edge, which significantly impacts displacement characteristics, and an optimal solution was determined.

Comparison results are shown in Fig. 12. Results of Optimal Solution A reveal a high Young's modulus and low density for the cone paper. This means that it is hard and light. Displacement characteristics were even for the entire diaphragm, thus confirming that the diaphragm did not vibrate efficiently. No resonance of the diaphragm and edge was observed, and the diaphragm was found to exhibit piston motion up to high frequencies. Results of Optimal Solution B revealed a peak and dip in characteristics; however, the efficiency was good. With paper materials, the diaphragm is soft and light, such that the motion of the voice coil is not transmitted throughout the diaphragm, and the motion tends to become divided. Therefore, dips and peaks tend to appear in the displacement.

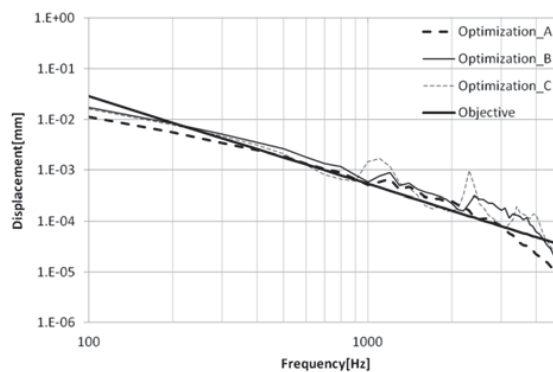

Fig. 12 Comparison of the optimal solutions of the three groups

Paper materials are easy to work with and offer a good balance of characteristics required for loudspeakers, and consequently account for most of the materials used for diaphragms. Metallic materials offer excellent specific modulus. However, internal loss is slight, so they are used mostly for middle-tone and high-tone diaphragms rather than for low frequency diaphragms.

Next, Optimal Solution C, which takes impact of the edge into account, was determined. The edge used in this study was made from another type of material, which was different from the diaphragm. It is called a "free edge," and is applied near the cone diaphragm. This edge offers free selection of material and better performance because it can be processed. The valley of the mid-range can be minimized by minimizing the area of the edge by applying a damping agent or pasting materials together. The performance required of loudspeaker diaphragms

was confirmed from the optimal solutions; the loudspeaker diaphragm was found to be sufficiently light and rigid.

In future, the authors would like to increase the design variables to include factors other than cone paper and edge and take into account other features of diaphragm materials. The authors would also like to perform optimal designs and demonstrate a method to optimize diaphragm materials.

#### V.CONCLUSION

The research described herein involved acoustic linkage analysis of loudspeakers with acoustic analysis software developed by the authors. This software takes into account the impact of air viscosity, which used to be impossible with conventional acoustic analytical methods. The research has further succeeded in facilitating the task of optimizing properties of loudspeaker part materials, as well as parameter design and calculation of acoustic characteristics of materials that are difficult or impossible to test fabricate. As a result of optimizing physical properties of loudspeaker parts using the response surface method, the research described herein has enabled vibration displacement of diaphragms to be minimized (objective function as optimal solution).

It is hoped that future research can lead to optimization design to realize even flatter acoustic pressure by changing shape as well as properties of cone materials.

#### REFERENCES

- [1] W. N. Brown Jr, "Theory of conical sound radiators," *J. Acoust. Soc. Am.*, Vol. 13, no. 1, pp. 20–22, 1941.7.
- [2] P. G. Bordon, "The conical sound source," *J. Acoust. Soc. Am.*, vol. 28, no. 2, pp. 123–126, 1945.
- [3] T. Nimura, E. Matsui, K. Shibayama, K. Kido, "Study on the cone type dynamic loudspeakers," *J. Acoust. Soc. Jpn.*, vol. 7, no. 2, pp. 16–28, 1952.
- [4] F. J. Frankfort, "Vibration and sound radiation of loudspeaker cones," Thesis, Delft(1975); also *Philips Res. Rep. Suppl.*, no. 2, 1975
- [5] T. Ueno, K. Takahashi, K. Ichida, S. Ishii, "The vibration analysis of a cone loudspeaker by the finite element method," *J. Acoust. Soc. Jpn.*, vol. 34, no. 8, pp. 470–477, 1978.
- [6] I. Suzuki, K. Nomoto, "Computerized analysis and observation of the vibration modes of a loudspeaker cone," *Journal audio Eng. Soc.*, no.1280, pp.1-9, 1982.
- [7] N. Kyouno, T. Usagawa, T. Yamabuchi, Y. Kagawa, "Acoustic response analysis of a cone-type loudspeaker by the finite element method," *J. Acoust. Soc. Jpn.*, vol. 61, no. 6, pp. 312–319, 2005.
- [8] Y. Nomura, K. Nagasawa, "Design of the phase inverter loudspeaker system by nonlinear optimization method," *J. Acoust. Soc. Jpn.*, vol. 34, no. 8, pp. 462–469, 1978.
- [9] F. Kusudo, "Design of loudspeaker by optimization method," *Reports of the spring meeting the Acoustical Society of Japan*, pp. 263–264, 1979
- [10] M. Sasajimai T. Yamaguchi, M. Watanabe, Y. Koike, "FEM analysis of a narrow acoustic sound pathway with rectangular cross section," *Society of Damping Technology*, vol. 12, 2014.
- [11] X. Zhao, "Some new problems and measure with structural optimization software development," *Proceedings of the Conference on Computational Engineering and Science*, vol. 12, no. 1, 129–132, 2007
- [12] X. Zhao, Y. Hu, I. Hagiwara, "Optimal design for crash characteristics of cylindrical thin-walled structure using origami engineering," *The Japan Society of Mechanical Engineers*, vol. 76, no. 761, 2010