

# Optimal Distribution of Lift Gas in Gas Lifted Oil Field Using MPC and Unscented Kalman Filter

Roshan Sharma and Bjørn Glemmestad

**Abstract**—In gas lifted oil fields, the lift gas should be distributed optimally among the wells which share gas from a common source to maximize total oil production. One of the objectives of the paper is to show that a linear MPC consisting of a control objective and an economic objective can be used both as an optimizer and a controller for gas lifted systems. The MPC is based on linearized model of the oil field developed from first principles modeling. Simulation results show that the total oil production is increased by 3.4%. Difficulties in accurately measuring the bottom hole pressure using sensors in harsh operating conditions can be resolved by using an Unscented Kalman Filter (UKF) for estimation. In oil fields where input disturbance (total supply of gas) is not measured, UKF can also be used for disturbance estimation. Increased total oil production due to optimization leads to increased profit.

**Keywords**—gas lift, MPC, oil production, optimization, Unscented Kalman filter.

## I. INTRODUCTION

A gas lifted oil well is an artificial lifting system where a high pressure lift gas is injected into the tubing of the oil well. The lift gas mixes with the liquid flowing from the reservoir and reduces the density of the liquid column. The decrease in the density reduces the hydrostatic pressure drop above the point of injection. The reservoir pressure will then be sufficient to overcome the sum of the pressure losses in the well and the well starts producing again or produces at higher production rates. The details of the operating principles of the gas lifted oil field can be viewed in the book by Takacs [1]. In a gas lifted oil field with multiple oil wells, usually the lift gas is supplied to each of the oil wells by a common gas distribution pipeline. Moreover, in most of the cases, the oil wells are physically separated by large distance ( in our case study of the Norne oil field, a 13km long gas pipeline distributes the gas to five oil wells). Thus due to differences in the bottom hole conditions of each well, the gas lift performance of the individual wells may vary from each other. In other words the Productivity Index (PI) for each well may be different such that each oil well may produce different amount of oil for equal amount of gas injected into them. It is beneficial to distribute the available lift gas among each oil wells in a gas lifted oil field in an optimal manner to maximize oil production.

Optimization of gas distribution is a topic of interest to many researchers. Penalty function or Sequential Unconstrained Minimization Technique (SUMT) which can accom-

modate both the equality constraints and inequality constraints needed to solve the non-linear optimization model of the gas allocation to a gas lifted oil field was proposed by Zhong et al. [2]. Daily well scheduling in gas lifted petroleum fields has been formulated and solved by using mixed integer nonlinear programming (MINLP) [3] where the discrete decisions include the operational status of wells, the allocation of wells to manifolds or separators and the allocation of flow lines to separators, and the continuous decisions include the well oil rates. Dynamic programming has been used for solving a gas-lift optimization problem where the gas-lift optimization problem can be casted as a mixed integer nonlinear programming problem whose integer variables decide which oil well should produce, while the continuous variables allocate the gas-compressing capacity to the active wells [4]. Computational scheme using genetic algorithm has been used to find optimum gas injection rate for gas lifted oil field [5], [6] and also for dual gas lift system [7]. For gas lift optimization, a high dimensional problem has been reduced into one single variable problem by using Newton reduction method based on upper convex profile [8].

The previous research works have not focused much on the usage of Model Predictive Controller (MPC) for the purpose of lift gas distribution. One of the very few papers about gas lift optimization and control with nonlinear MPC was proposed by [9] where the data from bottom hole pressure sensors was used for developing the prediction model for the oil field. However, this paper is focused on the development of a linear MPC based on a linearized model of the oil field developed from first principles modeling. The aim of the paper is to show that a linear MPC consisting of a control objective and an economic objective can be used both as an optimizer and a controller for gas lifted systems. There are no sensors installed at the bottom hole of the wells in the gas lifted oil field of our interest. Unscented Kalman Filter (UKF) has been developed for estimating the bottom hole pressure thus easing the difficult task of accurately measuring the bottom hole pressure under harsh working conditions. In this paper, it has been shown that UKF can also be used for input disturbance (total supply of lift gas from compressor) estimation in the oil fields where it is not measured.

Section II describes the problem formulation and explains why optimization and control is necessary. The dynamic model of the oil field used in this paper is described in section III. Formulation of UKF for estimation is described in Section IV. Section V provides a detailed explanation of how a linear MPC can be used for control and optimization of gas lifted oil field. The observation and simulation results are discussed

Roshan Sharma is with the Department of Electrical Engineering, Information Technology and Cybernetics, Telemark University College, Porsgrunn, Norway e-mail: roshan.sharma@hit.no

Bjørn Glemmestad is with the Department of Process, Energy and Environment, Telemark University College, Porsgrunn, Norway e-mail: bjorn.glemmestad@hit.no

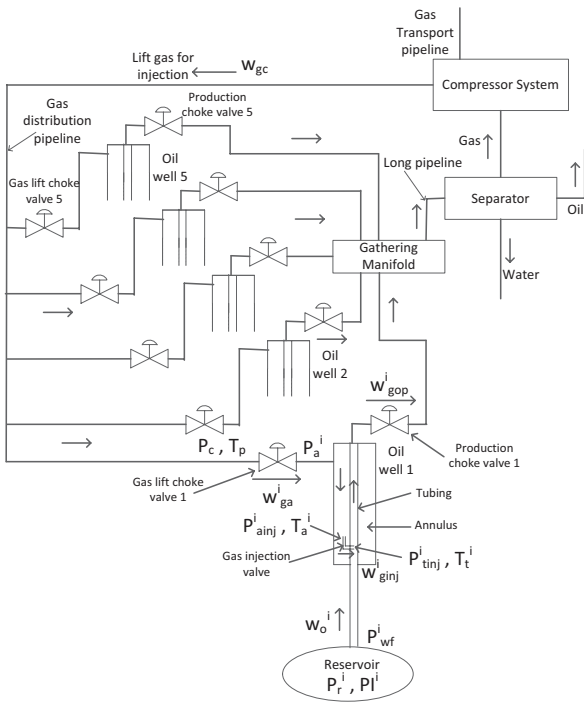

Fig. 1. Schematic of oil field

in Section VI.

II. PROBLEM DESCRIPTION

A simplified schematic of the Norne oil field showing the five gas lifted oil wells, the distribution pipeline and the gathering pipelines is shown in Figure 1.

The common gas distribution pipeline supplies gas to all the five oil wells. There is a gas lift choke valve on each oil wells which are used to control the amount of gas injection into each oil well. The production choke valves are assumed to be always fully open and are not used for control and optimization. It should be noted that the amount of oil produced by each well is a function of the amount of gas being injected into them. If we assume that each of the oil wells are identical in terms of their working condition, then a simple solution would be to distribute the gas equally among the wells. However, in real case scenarios, the oil wells are different and they produce different amount of oil for the same amount of gas injected into them. The well parameter Productivity Index (PI) is different for each of the oil well and correspondingly, the performance curve for each oil well is different as shown in Figure 2.

From the gas lift performance curve, it can be seen that the amount of oil produced as a function of gas injection first increases, reaches to a maximum and then fall back again. Moreover, the curves are different for each oil wells. Thus it is necessary to distribute the gas among the oil wells in an optimal manner to increase total oil production from the oil field.

In the process of maximizing total oil production, it should be noted that there are also some process variables which have

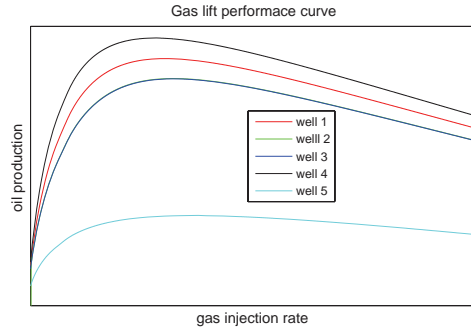

Fig. 2. Gas lift performance curves

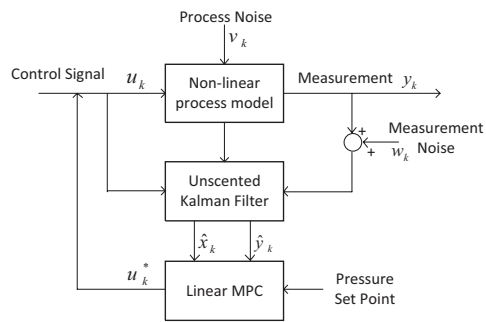

Fig. 3. Block diagram showing interconnection of MPC, UKF and the process

to be controlled. The compressed lift gas has to be injected to a large depths of more than 600 meters. For proper injection of the gas into the wells, the gas in the distribution pipeline should have sufficiently large driving pressure. Similarly, fluctuation in the gas supply pressure causes fluctuation in the gas flow rate and eventually fluctuation in the oil production. Hence the controller should control the flow rates of the lift gas being injected into the wells and should keep the pressure in the distribution pipeline around some designated set point.

In this paper, we propose a linear MPC consisting of both the control and economic objectives for solving the problem of optimal distribution of lift gas among the oil wells. The prediction model used by MPC is developed from the dynamic model of the oil field as described in section V(A). For obtaining a deterministic and stochastic model, process noises and measurement noises have been added to the model as white noises with random Gaussian distributed variables. The UKF will estimate states of the process, bottom hole pressure, input disturbance and also estimate the measurement variables. The output of the UKF will be fed as the input to the linear MPC which will then generate optimal control signals (gas lift choke valve openings) to minimize the control deviations and maximize the economic objective. A schematic of the process hierarchy containing the process model, the UKF and the MPC is shown in Figure 3.

### III. DYNAMIC MODEL OF THE OIL FIELD

A dynamic model of the oil field developed by Sharma et al. [10] using first principles modeling has been used here in this paper. Each oil well is modeled using four states. The four states used in the model are the mass of gas in the distribution pipeline ( $m_{gp}$ ), mass of gas in the annulus ( $m_{ga}^i$ ), mass of gas in the tubing above injection point ( $m_{gt}^i$ ) and the mass of liquid (oil) in the tubing above injection ( $m_{ot}^i$ ). Here the superscript  $i$  denotes the  $i^{th}$  oil well such that  $i = 1, 2, 3, 4, 5$ . If  $w_{gc}$  is the total mass flow rate of lift gas supplied by compressor and entering into the gas distribution pipeline (considered as input disturbance) and  $w_{ga}^i$  is the mass flow rate of gas injected into annulus i.e. mass flow rate leaving the gas distribution pipeline, then the mass balance in gas distribution manifold gives,

$$\dot{m}_{gp} = w_{gc} - \sum_{i=1}^5 w_{ga}^i \quad (1)$$

Mass flow rate through the gas lift choke valve ( $w_{ga}^i$ ) is obtained by using the standard flow equation developed by Instrument Society of America [11],

$$w_{ga}^i = N_6 C_v(u_1^i) Y_1^i \sqrt{\rho_{gp} \max(P_c - P_a^i, 0)} \quad (2)$$

$N_6 = 27.3$  is the valve constant,  $u_1^i$  is valve opening of the  $i^{th}$  gas lift choke valve expressed in percentage,  $P_c$  and  $P_a^i$  are the pressures upstream and downstream of the  $i^{th}$  gas lift choke valve,  $\rho_{gp}$  is the density of gas in the distribution pipeline which is a function of the upstream pressure  $P_c$ ,  $Y_1^i$  is the gas expansion factor and  $C_v(u_1^i)$  is the valve characteristic as a function of its opening. We assume the gas expansion factor ( $Y_1^i$ ) to be:

$$Y_1^i = 1 - \alpha_Y \left( \frac{P_c - P_a^i}{\max(P_c, P_c^{min})} \right), \alpha_Y = 0.66 \quad (3)$$

$P_c^{min}$  is the minimum pressure in the gas distribution pipeline. Valve characteristic as a function of its opening ( $C_v(u_1^i)$ ) is modeled by three linear equations as shown in Equation 4. The function in Equation 4 is fitted to the data supplied by the choke supplier.

$$C_v(u_1^i) = \begin{cases} 0 & u_1^i \leq 5 \\ 0.111u_1^i - 0.556 & 5 < u_1^i \leq 50 \\ 0.5u_1^i - 20 & u_1^i > 50 \end{cases} \quad (4)$$

Using gas law, the pressure upstream ( $P_c$ ) and downstream ( $P_a^i$ ) the gas lift choke valve can be found from the mass of gas,

$$P_c = \frac{z m_{gp} R T_p}{M A_p L_{p\_tl}} \quad (5)$$

$$P_a^i = \frac{z m_{ga}^i R T_a^i}{M A_a^i L_{a\_tl}^i} \quad (6)$$

$A_p$  and  $A_a^i$  are the cross sectional area of the gas distribution pipeline and annulus,  $L_{p\_tl}$  and  $L_{a\_tl}^i$  are the true/actual lengths of the gas distribution pipe and the annulus,  $M$  is the molar mass of the lift gas,  $R$  is the universal gas constant,  $T_p$  is the average temperature of lift gas in the common gas

distribution pipeline,  $T_a^i$  is the average temperature of lift gas in the annulus of the  $i^{th}$  well and  $z$  is the gas compressibility factor. The gas compressibility factor given by Equation 7 is expressed as a polynomial function of gas pressure  $P$  in bar (assuming constant temperature of 280K at the bottom of the sea). It is curve fitted (LSQ-method) to calculations from PVTsim [12] using the lift gas composition and assuming constant temperature.

$$z = -2.572 \times 10^{-8} P^3 + 2.322 \times 10^{-5} P^2 - 0.005077 P + 1 \quad (7)$$

Average density of the gas in the distribution pipe  $\rho_{gp}$  from definition is,

$$\rho_{gp} = \frac{m_{gp}}{A_p L_{p\_tl}} \quad (8)$$

Applying mass balance in annulus yields,

$$\dot{m}_{ga} = w_{ga}^i - w_{ginj}^i \quad (9)$$

$w_{ginj}^i$  is the mass flow rate of gas injected into the tubing from the annulus through the gas injection valve at the point of injection i.e. mass flow rate of gas leaving the annulus and  $w_{ga}^i$  is the mass flow rate of gas entering the annulus through the gas lift choke valve. The mass flow rate of the gas injected into the tubing from the annulus ( $w_{ginj}^i$ ) is,

$$w_{ginj}^i = K^i Y_2^i \sqrt{\rho_{ga}^i \max(P_{ainj}^i - P_{tinj}^i, 0)} \quad (10)$$

$K^i$  is the gas injection valve constant,  $P_{ainj}^i$  is the pressure upstream the gas injection valve in the annulus and  $P_{tinj}^i$  is the pressure downstream the gas injection valve in the tubing,  $\rho_{ga}^i$  is the average density of gas in the annulus.  $Y_2^i$  is the gas expandability factor given by,

$$Y_2^i = 1 - \alpha_Y \left( \frac{P_{ainj}^i - P_{tinj}^i}{\max(P_{ainj}^i, P_{ainj}^{min})} \right), \alpha_Y = 0.66$$

$P_{ainj}^{min}$  is the minimum pressure of lift gas in the annulus at the point of injection into the tubing.  $P_{ainj}^i$  is given by adding hydrostatic pressure drop to  $P_a^i$  as,

$$\begin{aligned} P_{ainj}^i &= P_a^i + \rho_{ga}^i g L_{a\_vl}^i \\ P_{ainj}^i &= P_a^i + \frac{m_{ga}^i g L_{a\_vl}^i}{A_a^i L_{a\_tl}^i} \end{aligned} \quad (11)$$

$L_{a\_vl}^i$  is the vertical depth of the annulus from the well head to the point of injection. Density of gas in the annulus ( $\rho_{ga}^i$ ) is a function of the average gas pressure,

$$\rho_{ga}^i = \frac{M(P_a^i + P_{ainj}^i)}{2zRT_a^i} \quad (12)$$

Denoting the pressure upstream the production choke valve in the tubing head to be  $P_{wh}^i$ , the average gas pressure  $\bar{P}_G^i$  in the tubing above point of injection is,

$$\bar{P}_G^i \approx \frac{P_{wh}^i + P_{tinj}^i}{2} \quad (13)$$

The volume of gas present in the tubing above the gas injection point ( $V_G^i$ ) can be found by subtracting the volume of oil present inside the tubing from the total volume of the tubing above the gas injection point.

$$V_G^i = A_t^i L_{t\_tl}^i - m_{ot}^i / \rho_o$$

$A_t^i$  is the inner cross sectional area of the tubing,  $L_{t\_tl}^i$  is the actual length of tubing above the gas injection point and  $\rho_o$  is the density of crude oil which is assumed to be 700 kg/m<sup>3</sup>. Using gas law,

$$\bar{P}_G^i V_G^i = z \frac{m_{gt}^i}{M} RT_t^i$$

Putting the value of  $\bar{P}_G^i$  from Equation 13 we get,

$$\frac{P_{wh}^i + P_{tinj}^i}{2} V_G^i = z \frac{m_{gt}^i}{M} RT_t^i \quad (14)$$

$T_t^i$  is the average temperature of the fluid/gas in the tubing. Pressure in the tubing downstream the gas injection valve ( $P_{tinj}^i$ ) can be found by adding the hydrostatic pressure to well head pressure in tubing as,

$$P_{tinj}^i = P_{wh}^i + \rho_m^i g L_{t\_vl}^i \quad (15)$$

$\rho_m^i$  is the average density of the mixture of the oil and gas in the tubing above the gas injection point and is given by,

$$\rho_m^i = \frac{m_{gt}^i + m_{ot}^i}{A_t^i L_{t\_tl}^i}$$

Solving Equations 14 and 15 we get,

$$P_{wh}^i = \frac{z m_{gt}^i}{M V_G^i} RT_t^i - \frac{\rho_m^i g L_{t\_vl}^i}{2} \quad (16)$$

$$P_{tinj}^i = \frac{z m_{gt}^i}{M V_G^i} RT_t^i - \frac{\rho_m^i g L_{t\_vl}^i}{2} + \rho_m^i g L_{t\_vl}^i \quad (17)$$

The bottom hole pressure or well flow pressure ( $P_{wf}^i$ ) is obtained by adding hydrostatic pressure drop to  $P_{tinj}^i$  as,

$$P_{wf}^i = P_{tinj}^i + \rho_o g L_{r\_vl}^i \quad (18)$$

$L_{r\_vl}^i$  is the vertical length of the tubing below the gas injection point up to reservoir opening. The mass flow rate of crude oil flowing from the reservoir into the tubing ( $w_o^i$ ) is calculated using the PI (Productivity Index) model of the well ([13] and [14]).

$$w_o^i = PI^i \max(P_r^i - P_{wf}^i, 0) \quad (19)$$

$P_r^i$  is the reservoir pressure which is assumed to be constant at 150 bar. The valve constant of the production choke valve is assumed to be at least 10 times more than that of the gas lift choke valve. The mass flow rate of the mixture of gas and oil through the production choke valve ( $w_{gop}^i$ ) is given by,

$$w_{gop}^i = 10 N_6 C_v(u_2^i) Y_2^i \sqrt{\rho_m^i \max(P_{wh}^i - P_s, 0)} \quad (20)$$

$u_2^i$  is the valve opening of production choke valve which is kept at full 100% open.  $C_v(u_2^i)$  satisfy Equation 4 replacing  $u_1^i$  by  $u_2^i$ .  $P_s$  is the pressure of the common gathering manifold assumed to be at 30 bar i.e. it is the pressure downstream the production choke valve.  $Y_3^i$  is gas expandability factor given by,

$$Y_3^i = 1 - \alpha_Y \left( \frac{P_{wh}^i - P_s}{\max(P_{wh}^i, P_{wh}^{min})} \right), \alpha_Y = 0.66$$

$P_{wh}^{min}$  is the minimum pressure in the tubing at the well head. Mass fraction is utilized to estimate the flow rates of oil ( $w_{op}^i$ )

and gas ( $w_{gp}^i$ ) through the production choke valve individually as,

$$w_{gp}^i = \frac{m_{gt}^i}{m_{gt}^i + m_{ot}^i} w_{gop}^i \quad (21)$$

$$w_{op}^i = \frac{m_{ot}^i}{m_{gt}^i + m_{ot}^i} w_{gop}^i \quad (22)$$

Finally, mass balances of oil and gas inside the tubing above the gas injection point are:

$$\dot{m}_{gt}^i = w_{ginj}^i - w_{gp}^i \quad (23)$$

$$\dot{m}_{ot}^i = w_o^i - w_{op}^i \quad (24)$$

To develop a linear MPC for control and optimization, the dynamic model of the oil field was linearized around the nominal operating points and then discretized. Let us denote the states by vector  $x$  such that

$$x = [m_{gp}^i, m_{ga}^i, m_{gt}^i, m_{ot}^i]^T \in \mathbb{R}^{n \times 1}$$

$$n = 16, i = 1, 2, 3, 4, 5$$

There are five controlled variables each corresponding to gas lift choke valve opening of each oil well denoted by vector  $u$  such that,

$$u = [u_1^1, u_1^2, u_1^3, u_1^4, u_1^5]^T \in \mathbb{R}^{r \times 1}, r = 5$$

There are eight process parameters of interest denoted by vector  $\theta$  such that,

$$\theta = [w_{gc}, P_s, P_r, u_2^i]^T \in \mathbb{R}^{8 \times 1}$$

Here  $w_{gc}$  which is the total supply of available lift gas is considered to be the only input disturbance to the system. There are 16 measurement variables denoted by vector  $y$  such that

$$y = g_i = [P_c, w_{ga}^i, w_o^i, P_{wf}^i]^T = g(x, u, t) \in \mathbb{R}^{m \times 1}, m = 16$$

To obtain a stochastic and deterministic discrete linear model of the oil field, process and measurement noises which are modeled as randomly distributed white Gaussian noises are added to the deterministic model and is given by,

$$x_{k+1} = A_d x_k + B_d u_k + C_d \theta_k + p_k \quad (25)$$

$$y_k = D_d x_k + E_d u_k + m_k \quad (26)$$

where  $p_k \in \mathbb{R}^{n \times 1}$  = process disturbance (to take into account the uncertainties in process modeling) such that  $E(p_k) = 0$  and  $E(p_k p_k^T) = P_{noise} \in \mathbb{R}^{n \times n}$  = process noise covariance matrix (given). Similarly,  $m_k \in \mathbb{R}^{m \times 1}$  = measurement noise such that  $E(m_k) = 0$  and  $E(m_k m_k^T) = M_{noise} \in \mathbb{R}^{m \times m}$  = measurement noise covariance matrix (given).

## IV. UNSCENTED KALMAN FILTER(UKF)

For the estimation of the input disturbance, it is assumed to be slowly varying or constant and is modeled as,

$$\dot{\theta}_1 = \dot{\theta}(1) = \delta\theta$$

where  $\delta\theta$  is white noise. The input disturbance model has to be augmented with the nonlinear model of the process for estimation as,

$$x = \begin{bmatrix} x \\ \theta_1 \end{bmatrix}$$

$$x_{k+1} = f(x_k, u_k, \theta_k, t_k) + p_k \quad x \in \mathbb{R}^{(n+1) \times 1}$$

$$y_k = g(x_k, u_k) + m_k \quad x \in \mathbb{R}^{m \times 1}$$

After augmenting, the process noise covariance matrix is  $P_{noise} \in \mathbb{R}^{(n+1) \times (n+1)}$ . The steps followed in designing the UKF for the oil field process are listed below [15]:

- Set the known initial mean  $\hat{x}_k^+ = \hat{x}_0^+$  for  $k = 0$  and known initial covariance  $P_k^+ = P_0^+$  for  $k = 0$  of the system states.

- Choose  $2n$  sigma points  $\hat{x}_k^{(i)}$  as

$$\hat{x}_k^{(i)} = \left( \sqrt{nP_k^+} \right)_i^T \quad i = 1, \dots, n$$

$$\tilde{x}_k^{(n+i)} = - \left( \sqrt{nP_k^+} \right)_i^T \quad i = 1, \dots, n$$

$$\hat{x}_k^{(i)} = \hat{x}_k^+ + \tilde{x}_k^{(i)} \quad i = 1, \dots, 2n$$

- Perform the unscented transformation of the sigma points to find transformed vectors  $\hat{x}_{k+1}^{(i)}$  using the nonlinear model  $f(\cdot)$

$$\hat{x}_{k+1}^{(i)} = f(\hat{x}_k^{(i)}, u_k, \theta_k, t_k)$$

- Find the mean of the transformed vectors  $\hat{x}_{k+1}^{(i)}$  to obtain *a priori* state estimate.

$$\hat{x}_{k+1}^- = \frac{1}{2n} \sum_{i=1}^{2n} \hat{x}_{k+1}^{(i)}$$

- Estimate the *a priori* error covariance and add the given process noise covariance matrix.

$$P_{k+1}^- = \frac{1}{2n} \sum_{i=1}^{2n} (\hat{x}_{k+1}^{(i)} - \hat{x}_{k+1}^-)(\hat{x}_{k+1}^{(i)} - \hat{x}_{k+1}^-)^T + P_{noise}$$

- Using the *a priori* state estimate  $\hat{x}_{k+1}^-$  and *a priori* error covariance  $P_{k+1}^-$ , choose  $2n$  sigma points

$$\tilde{x}_k^{(i)} = \left( \sqrt{nP_{k+1}^-} \right)_i^T \quad i = 1, \dots, n$$

$$\tilde{x}_k^{(n+i)} = - \left( \sqrt{nP_{k+1}^-} \right)_i^T \quad i = 1, \dots, n$$

$$\hat{x}_{k+1}^{(i)} = \hat{x}_{k+1}^- + \tilde{x}_k^{(i)} \quad i = 1, \dots, 2n$$

- Transform the sigma points  $\hat{x}_{k+1}^{(i)}$  into predicted measurements vector  $\hat{y}_k^{(i)}$  using the nonlinear measurement equation  $g(\cdot)$

$$\hat{y}_k^{(i)} = g(\hat{x}_{k+1}^{(i)}, u_k, t_k)$$

- Find the mean of the predicted measurement vector to obtain the predicted measurement at time  $k$

$$\hat{y}_k = \frac{1}{2n} \sum_{i=1}^{2n} \hat{y}_k^{(i)}$$

- Obtain the covariance of the predicted measurement and add the given measurement noise covariance matrix.

$$P_y = \frac{1}{2n} \sum_{i=1}^{2n} (\hat{y}_k^{(i)} - \hat{y}_k)(\hat{y}_k^{(i)} - \hat{y}_k)^T + M_{noise}$$

- Obtain the cross covariance matrix between *a priori* states estimate  $\hat{x}_{k+1}^-$  and measurements estimate  $\hat{y}_k$ .

$$P_{xy} = \frac{1}{2n} \sum_{i=1}^{2n} (\hat{x}_{k+1}^- - \hat{x}_{k+1}^-)(\hat{y}_k^{(i)} - \hat{y}_k)^T$$

- Find the Kalman gain and update the *a posteriori* states and covariance estimates.

$$K_k = P_{xy}P_y^{-1}$$

$$\hat{x}_{k+1}^+ = \hat{x}_{k+1}^- + K_k(y_k - \hat{y}_k)$$

$$P_{k+1}^+ = P_{k+1}^- - K_k P_y K_k^T$$

- Repeat the above steps for  $k = 1, 2, \dots$  until end of simulation time.

## V. MPC PROBLEM FORMULATION

The system states, measurements and input disturbance estimated by UKF is fed as input to the MPC. For simplicity and generality let us denote the estimated states and estimated measurements as  $x_k = \hat{x}_k^+$  and  $y_k = \hat{y}_k$  respectively. As also mentioned in the problem formulation, the goal is to maximize the total oil production from the wells while still maintaining the pressure of distribution pipeline to a prescribed set point. So the variables of interest are  $P_c$  and  $\sum_{i=1}^5 w_o^i$ . The measurements given by Equation 26 consist of 16 measurements. For simplicity, let us choose only two measurements ( $P_c$  and  $w_o^i$ ) and reformulate the measurement equation for each of the variable of interest as, For measuring  $P_c$ :

$$y_k^c = D_d^c x_k + m_k^c \in \mathbb{R}^{m^c \times 1} \quad \text{with } m^c = 1 \quad (27)$$

For measuring total oil production ( $\sum_{i=1}^5 w_o^i$ ):

$$y_k^e = D_d^e x_k + m_k^e \in \mathbb{R}^{m^e \times 1} \quad \text{with } m^e = 1 \quad (28)$$

Here  $D_d^c \in \mathbb{R}^{m^c \times n}$  and  $D_d^e \in \mathbb{R}^{m^e \times n}$  are the subsets of the matrix  $D_d$ ;  $m_k^e$  and  $m_k^c$  are the subsets of the matrix  $m_k$  of Equation 26. It should be noted that for measuring  $y_k^c$  and  $y_k^e$ , the subsets of the matrix  $E_d$  of Equation 26 is zero. The remaining 14 measurement variables can be measured using the nonlinear measurement equation  $y_k = g(x_k, u_k)$  and also estimated ( $\hat{y}_k$ ) using UKF. The equation for the state vectors is,

$$x_{k+1} = A_d x_k + B_d u_k + C_d \theta_k + p_k \quad (29)$$

The objective function of MPC consists of both a control objective and the economic objective. Let us choose a linear quadratic cost function with a prediction horizon  $L$  as,

$$J_k = \sum_{i=1}^L \underbrace{(y_{k+i}^c - r_{k+i})^T Q_1^i (y_{k+i}^c - r_{k+i})}_{\text{control objective}} + \underbrace{\Delta u_{k+i-1}^T P_i \Delta u_{k+i-1} - (y_{k+i}^e)^T Q_2^i (y_{k+i}^e)}_{\text{economic objective}} \quad (30)$$

Here  $Q_1^i \in \mathbb{R}^{m^c \times m^c}$ ,  $P_i \in \mathbb{R}^{r \times r}$  and  $Q_2^i \in \mathbb{R}^{m^e \times m^e} \forall i = 1, 2, \dots, L$  are the symmetric positive semidefinite weighting matrices,  $r_k$  is the reference vector and  $\Delta u_k = u_k - u_{k-1}$  is the control signal in deviation form. The individual strength of control and economic objective is dependent on the values of their weighting matrices. If  $Q_1^i$  is chosen to be low and  $Q_2^i$  is chosen to be significantly high then the control objective will not be strictly followed. This will result in some steady state deviation from the control objective set point. However, in this paper the weighting matrices are appropriately chosen and both the objectives are fairly satisfied. The cost function of Equation 30 can be written in compact form as,

$$J_k = (y_{k+1|L}^c - r_{k+1|L})^T Q_1 (y_{k+1|L}^c - r_{k+1|L}) + \Delta u_{k|L}^T P \Delta u_{k|L} - (y_{k+1|L}^e)^T Q_2 (y_{k+1|L}^e) \quad (31)$$

Notation:

$$\Delta u_{k|L} \stackrel{\text{def}}{=} \begin{bmatrix} \Delta u_k \\ \Delta u_{k+1} \\ \vdots \\ \Delta u_{k+L-1} \end{bmatrix}, y_{k+1|L}^c \stackrel{\text{def}}{=} \begin{bmatrix} y_{k+1}^c \\ y_{k+2}^c \\ \vdots \\ y_{k+L}^c \end{bmatrix}$$

$$y_{k+1|L}^e \stackrel{\text{def}}{=} \begin{bmatrix} y_{k+1}^e \\ y_{k+2}^e \\ \vdots \\ y_{k+L}^e \end{bmatrix}, r_{k+1|L} \stackrel{\text{def}}{=} \begin{bmatrix} r_{k+1} \\ r_{k+2} \\ \vdots \\ r_{k+L} \end{bmatrix}$$

$Q_1 \in \mathbb{R}^{Lm^c \times Lm^c} = \text{diag}(Q_1^1, Q_1^2, \dots, Q_1^L)$ ,  $P \in \mathbb{R}^{Lr \times Lr} = \text{diag}(P_1, P_2, \dots, P_L)$  and  $Q_2 \in \mathbb{R}^{Lm^e \times Lm^e} = \text{diag}(Q_2^1, Q_2^2, \dots, Q_2^L)$  are symmetric and positive semidefinite block diagonal weighting matrices.

#### A. Prediction Model

The prediction model to be used in MPC can be obtained from the state space model of Equations 27, 28 and 29. In the deviation form, the linear models will be independent of the process disturbance and measurement noises. We have from Equation 29,

$$x_{k+1} - x_k = A_d(x_k - x_{k-1}) + B_d(u_k - u_{k-1})$$

Denoting  $\Delta x = x_k - x_{k-1}$  and  $\Delta u_k = u_k - u_{k-1}$  we get,

$$\Delta x_{k+1} = A_d \Delta x_k + B_d \Delta u_k \quad (32)$$

Also in deviation form, Equations 27 and 28 can be written as,

$$y_k^c = y_{k-1}^c + D_d^c \Delta x_k \quad (33)$$

$$y_k^e = y_{k-1}^e + D_d^e \Delta x_k \quad (34)$$

Augmenting Equations 32 and 33 for the control objective we get,

$$\begin{bmatrix} \Delta x_{k+1} \\ y_k^c \end{bmatrix} = \underbrace{\begin{bmatrix} A_d & 0 \\ D_d^c & I \end{bmatrix}}_{\hat{A}} \underbrace{\begin{bmatrix} \Delta x_k \\ y_{k-1}^c \end{bmatrix}}_{\hat{x}_k} + \underbrace{\begin{bmatrix} B_d \\ 0 \end{bmatrix}}_{\hat{B}} \Delta u_k \quad (35)$$

$$y_k^c = \underbrace{\begin{bmatrix} D_d^c & I \end{bmatrix}}_{\hat{D}} \underbrace{\begin{bmatrix} \Delta x_k \\ y_{k-1}^c \end{bmatrix}}_{\hat{x}_k} \quad (36)$$

Augmenting Equations 32 and 34 for the economic objective we get,

$$\begin{bmatrix} \Delta x_{k+1} \\ y_k^e \end{bmatrix} = \underbrace{\begin{bmatrix} A_d & 0 \\ D_d^e & I \end{bmatrix}}_{\hat{A}} \underbrace{\begin{bmatrix} \Delta x_k \\ y_{k-1}^e \end{bmatrix}}_{\hat{x}_k} + \underbrace{\begin{bmatrix} B_d \\ 0 \end{bmatrix}}_{\hat{B}} \Delta u_k \quad (37)$$

$$y_k^e = \underbrace{\begin{bmatrix} D_d^e & I \end{bmatrix}}_{\hat{D}} \underbrace{\begin{bmatrix} \Delta x_k \\ y_{k-1}^e \end{bmatrix}}_{\hat{x}_k} \quad (38)$$

Considering the augmented state space model of Equations 35 and 36, a Prediction Model (PM) for the control objective can be written as, [16]

$$y_{k+1|L}^c = \tilde{p}_L(k) + \tilde{F}_L \Delta u_{k|L} \quad (39)$$

The term  $\tilde{p}_L(k)$  is completely known. It depends upon the process model, known past and present process output variables and known past process control input variables defined by the *identification horizon*  $J$ . It is given by,

$$\tilde{p}_L(k) = \tilde{O}_L \tilde{A}^J \tilde{O}_J^\dagger y_{k-J+1|J}^c + \tilde{P}_L \Delta u_{k-J+1|J-1} \quad (40)$$

Here,  $\tilde{O}_L$  is the extended observability matrix for the pair  $(\tilde{D}, \tilde{A})$ . It is defined as,

$$\tilde{O}_L \stackrel{\text{def}}{=} \begin{bmatrix} \tilde{D} \\ \tilde{D}\tilde{A} \\ \vdots \\ \tilde{D}\tilde{A}^{L-1} \end{bmatrix} \in \mathbb{R}^{Lm^c \times n+1} \quad (41)$$

$\tilde{O}_J^\dagger = (\tilde{O}_J^T \tilde{O}_J)^{-1} \tilde{O}_J^T$  is the Moore-Penrose pseudo-inverse of  $\tilde{O}_J$ . The matrix  $\tilde{P}_L$  is related to past control inputs and is given by

$$\tilde{P}_L = \tilde{O}_L \tilde{A} \tilde{C}_{J-1}^d - \tilde{O}_L \tilde{A}^J \tilde{O}_J^\dagger \tilde{H}_J^d \in \mathbb{R}^{Lm^c \times (J-1)r} \quad (42)$$

The reversed extended controllability matrix  $\tilde{C}_{J-1}^d$  for the pair  $(\tilde{A}, \tilde{B})$  is defined as,

$$\tilde{C}_{J-1}^d \stackrel{\text{def}}{=} [\tilde{A}^{J-2} \tilde{B} \quad \tilde{A}^{J-3} \tilde{B} \quad \dots \quad \tilde{B}] \in \mathbb{R}^{(n+1) \times (J-1)r} \quad (43)$$

The lower block triangular Toeplitz matrix  $\tilde{H}_J^d \in \mathbb{R}^{Jm^c \times (L-1)r}$  for the triple  $(\tilde{D}, \tilde{A}, \tilde{B})$  is defined as,

$$\tilde{H}_J^d = \begin{bmatrix} 0 & 0 & \dots & 0 \\ \tilde{D}\tilde{B} & 0 & \dots & 0 \\ \tilde{D}\tilde{A}\tilde{B} & \tilde{D}\tilde{B} & \ddots & 0 \\ \tilde{D}\tilde{A}^{J-2}\tilde{B} & \tilde{D}\tilde{A}^{J-3}\tilde{B} & \dots & \tilde{D}\tilde{B} \end{bmatrix} \quad (44)$$

$\tilde{F}_L$  is related to the present and future control input and is given by,

$$\tilde{F}_L = [ \tilde{O}_L \tilde{B} \quad \tilde{H}_L^d ] \in \mathbb{R}^{Lm^c \times Lr} \quad (45)$$

$\tilde{H}_L^d$  is the lower block triangular Toeplitz matrix for the triple  $(\tilde{D}, \tilde{A}, \tilde{B})$  for the prediction horizon  $L$ . In the same way, considering the state space model of Equations 37 and 38, the Prediction Model for the economic objective can be written as,

$$y_{k+1|L}^e = \hat{p}_L(k) + \hat{F}_L \Delta u_{k|L} \quad (46)$$

with  $\hat{p}_L(k)$  and  $\hat{F}_L$  as defined before for Prediction Model for control objective but replacing  $\tilde{\cdot}$  with  $\hat{\cdot}$ .

### B. Constraints

The input rate constraint may be written as,

$$\Delta u^{min} \leq \Delta u_{k|L} \leq \Delta u^{max} \quad (47)$$

It may be written as linear matrix inequality as,

$$\Delta u_{k|L} \leq \Delta u^{max} \quad (48)$$

$$-\Delta u_{k|L} \leq -\Delta u^{min} \quad (49)$$

The input amplitude constraint can be written as,

$$u^{min} \leq u_{k|L} \leq u^{max} \quad (50)$$

The equation relating  $u_{k|L}$  and  $\Delta u_{k|L}$  is, [16]

$$u_{k|L} = S \Delta u_{k|L} + cu_{k-1} \quad (51)$$

where  $S \in \mathbb{R}^{Lr \times Lr}$  and  $c \in \mathbb{R}^{Lr \times r}$  are given by,

$$S = \begin{bmatrix} I_r & 0_r & \cdots & 0_r \\ I_r & I_r & \cdots & 0_r \\ \vdots & \vdots & \ddots & \vdots \\ I_r & I_r & \cdots & I_r \end{bmatrix}, \quad c = \begin{bmatrix} I_r \\ I_r \\ \vdots \\ I_r \end{bmatrix}$$

where  $I_r$  is the  $r \times r$  identity matrix and  $0_r$  is the  $r \times r$  matrix of zeros. As linear matrix inequality it can be written as,

$$S \Delta u_{k|L} \leq u^{max} - cu_{k-1} \quad (52)$$

$$-S \Delta u_{k|L} \leq -u^{min} + cu_{k-1} \quad (53)$$

Combining Equations 48, 49, 52 and 53 as linear inequality we can write as,

$$\underbrace{\begin{bmatrix} I \\ -I \\ S \\ -S \end{bmatrix}}_A \Delta u_{k|L} \leq \underbrace{\begin{bmatrix} \Delta u^{max} \\ -\Delta u^{min} \\ u^{max} - cu_{k-1} \\ -u^{min} + cu_{k-1} \end{bmatrix}}_{b_k} \quad (54)$$

### C. Solving the MPC problem

Putting the Prediction Models given by Equations 39 and 46 into the objective function of Equation 31 we get,

$$J_k = (\tilde{p}_L - r_{k+1|L} + \tilde{F}_L \Delta u_{k|L})^T Q_1 (\tilde{p}_L - r_{k+1|L} + \tilde{F}_L \Delta u_{k|L}) + \Delta u_{k|L}^T P \Delta u_{k|L} - (\hat{p}_L + \hat{F}_L \Delta u_{k|L})^T Q_2 (\hat{p}_L + \hat{F}_L \Delta u_{k|L}) \quad (55)$$

On solving and arranging we finally get,

$$J_k = \Delta u_{k|L}^T H \Delta u_{k|L} + 2f_k^T \Delta u_{k|L} + J_0 \quad (56)$$

where,

$H = P + \tilde{F}_L^T Q_1 \tilde{F}_L - \hat{F}_L^T Q_2 \hat{F}_L =$  Hessian matrix which is positive definite and constant

$f_k = \tilde{F}_L^T Q_1 (\tilde{p}_L - r_{k+1|L}) - \hat{F}_L^T Q_2 \hat{p}_L =$  vector which is independent of unknown control deviation variable.

$J_0 = (\tilde{p}_L - r_{k+1|L})^T Q_1 (\tilde{p}_L - r_{k+1|L}) - \hat{p}_L^T Q_2 \hat{p}_L =$  scalar which does not effect optimization problem.

The MPC problem is a Quadratic Programming (QP) problem,

$$\min_{\Delta u_{k|L}} (\Delta u_{k|L}^T H \Delta u_{k|L} + 2f_k^T \Delta u_{k|L})$$

subject to

$$A \Delta u_{k|L} \leq b_k$$

The QP problem was solved in MATLAB using the optimization toolbox. The optimal control deviation signal is given by,

$$\Delta u_{k|L}^* = \begin{bmatrix} \Delta u_k^* \\ \Delta u_{k+1}^* \\ \vdots \\ \Delta u_{k+L-1}^* \end{bmatrix}$$

Only  $\Delta u_k^*$  is used. The current optimal control signal is calculated as,

$$u_k^* = u_{k-1} + \Delta u_k^* \quad (57)$$

## VI. SIMULATION RESULTS

The parameters of the oil field used in the simulation are listed in Table I. MATLAB was used as the tool for all the simulation results. For each oil well, it was assumed that  $u^{min} = 15\%$  and  $u^{max} = 100\%$ . The total lift gas supply was considered to be the input disturbance. For all the simulations, process noises (to account for process modeling uncertainties) and measurement noises (to simulate real case scenario) were added for robustness.

### A. Considering only control objective

At first, the oil field was simulated with only the control objective. This can be achieved by setting the weighting matrix  $Q_2 = 0$  in Equation 31.

The pressure set point of gas distribution pipeline is 200 bar. As can be seen from Figure 4(a), the controller keeps track of the set point. Both the simulated output (with process noise + measurement noise) and the estimated output using UKF has been shown. At simulation time = 4 hours, input disturbance was applied by reducing the total supply of lift

TABLE I  
PARAMETERS OF OIL FIELD

Parameters	Well 1	Well 2	Well 3	Well 4	Well 5	Unit
$L_{p,tl}$	13000					meter
$L_{a,tl}/L_{t,tl}$	2758	2559	2677	2382	2454	meter
$L_{a,vl}/L_{t,vl}$	2271	2344	1863	1793	1789	meter
$ID_a$	9.63	9.63	9.63	9.63	9.63	inch
$ID_t$	6.18	6.18	6.18	6.18	6.18	inch
$OD_t$	7.64	7.64	7.64	7.64	7.64	inch
$L_{r,vl}$	114	67	61	97	146	meter
$P_r$	150					bar
$P_s$	30					bar
$w_{gc}$	40000 (at normal operation)					$Sm^3/hr$
$PI(1.0e+4)$	2.51	1.63	1.62	4.75	0.232	$\frac{kg/hr}{bar}$
$K$	68.43	67.82	67.82	69.26	66.22	$\sqrt{\frac{kgm^3}{bar \cdot hr}}$

ID = Internal Diameter, OD = Outer Diameter

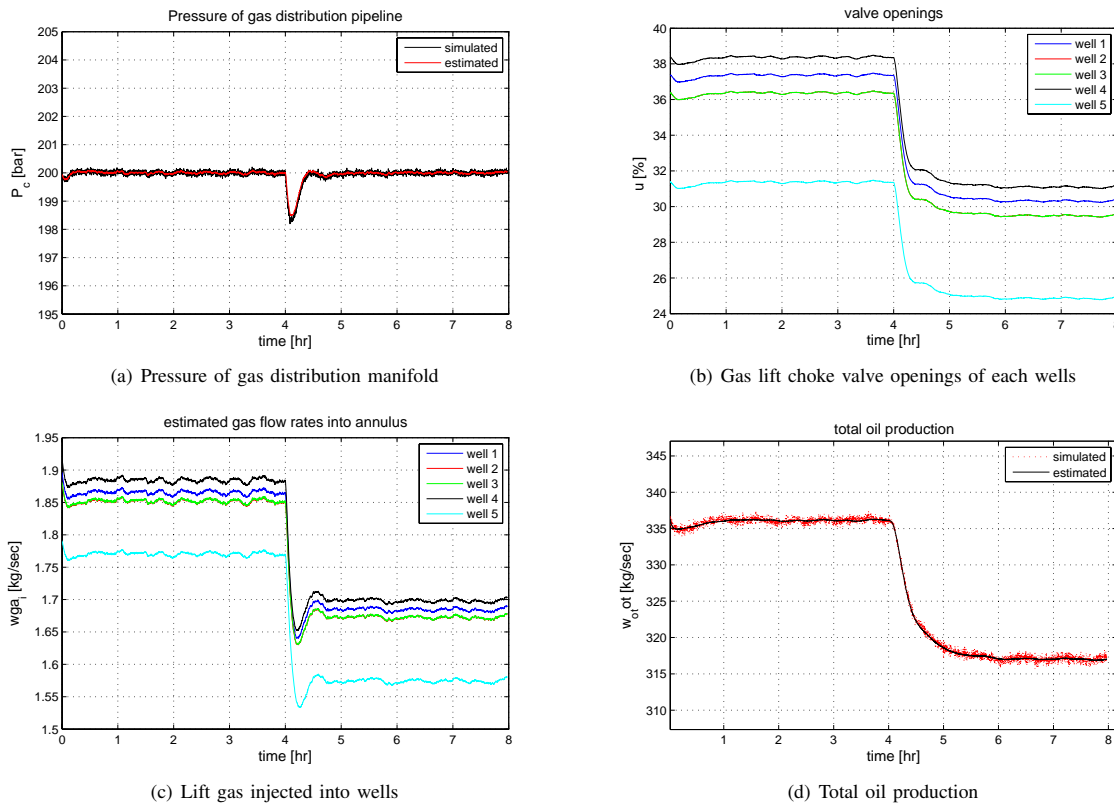

Fig. 4. Simulation results with control objective but without economic objective

gas from 40000  $Sm^3/hr$  to 36000  $Sm^3/hr$ . The MPC controller regulated the pressure by manipulating the valve openings of all the five oil wells as shown in Figure 4(b) when disturbance was applied at time = 4 hrs.

The total oil produced from the oil field when the economic objective was not considered is shown in Figure 4(d). Under normal supply of lift gas ( $0 \leq \text{time} \leq 4$  hrs), the total oil produced was about 336 kg/sec. Due to input disturbance acting at time = 4 hrs, where the supply of lift gas was reduced, the total oil produced by the field was also reduced to about 317 kg/sec. When the economic objective was not considered, the available lift gas was distributed among the five oil wells

as shown in Figure 4(c). This distribution however is not optimal with respect to maximizing total oil production. The production of oil by the individual wells is shown in Figure 5. The values of the productivity indices have the following relationship:  $PI4 > PI1 > PI2 \approx PI3 > PI5$ . Oil well 4 owing to highest PI value produces the most, about 90 kg/sec. Oil well 5 owing to the lowest PI value produces the least, about 30 kg/sec. Oil wells 2 and 3 produce almost identical, about 68 kg/sec each. It can also be seen that due to the application of input disturbance at time = 4 hrs, the oil produced by individual wells were also decreased. This is because the oil produced from a well is a function of amount



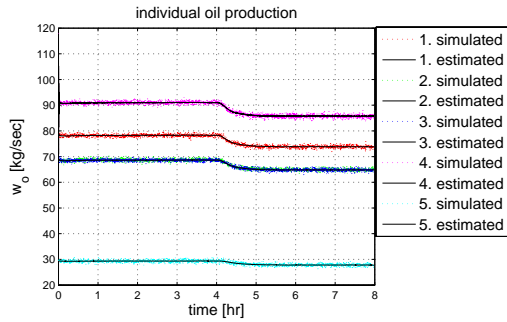

Fig. 5. Oil produced by individual wells with control objective but without economic objective

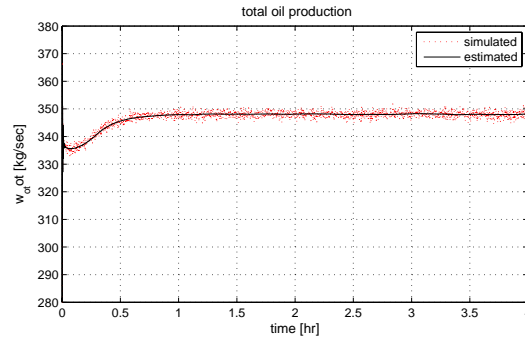
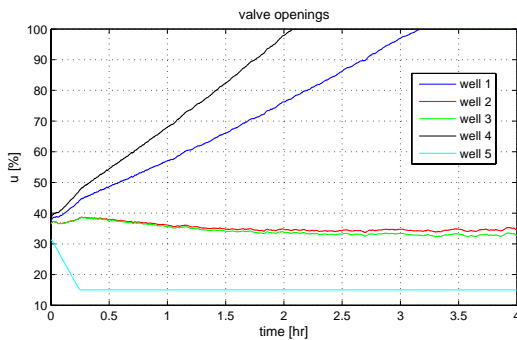
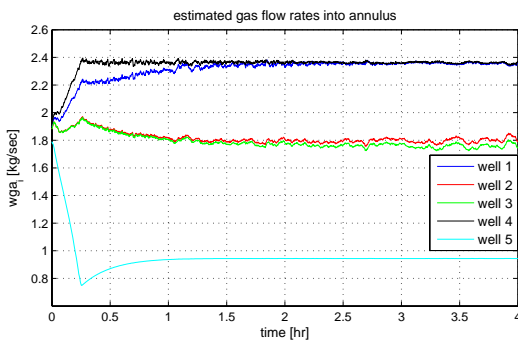

Fig. 7. Total oil production with both control and economic objectives



(a) Gas lift choke valve openings of each well



(b) Lift gas injection into each well

Fig. 6. Simulation results with both control and economic objectives

of gas injected into the well (see the gas lift performance curve of Figure 2).

### B. Considering both the control and economic objective

To show that the same MPC can also be used as an optimizer, simulation was performed with the economic objective taken into consideration i.e. taking  $Q_2 > 0$  in Equation 31. The economic objective is used to maximize the total oil production from the oil field using the available lift gas. Simulation was started with the same valve openings as was used for the previous case with only control objective. However, due to the presence of the economic objective for this case, the MPC instantaneously redistributed the available

lift gas. The re-distribution took place in accordance to the PI values of each oil well (see Figure 6). The supply of lift gas into well 5 which has the least PI value was continuously decreased until the lower bound of  $u^{min} = 15\%$  valve opening was active. The supply of lift gas into wells 2 and 3 with  $(PI_2 \approx PI_3) < PI_4 \& PI_5$  were also decreased. Both these wells received higher amount of lift gas than well 5 but lesser than well 4 and well 1. Well 4 with highest PI value is the first oil well to receive the highest amount of lift gas shortly followed by well 1. As can be seen from Figure 6(a), the valve opening of well 4 was increased continuously and it is the first oil well to reach to its  $u^{max} = 100\%$  fully opened valve condition (its upper bound). It remained at its upper bound for the given supply of lift gas. Oil well 1 is the second oil well to receive the same amount of gas as well 4 but only after well 4 has reached its upper bound. Among wells 2 and 3,  $PI_2$  is slightly greater than  $PI_3$  (see Table I). The simulation result in Figure 6(b) shows that the optimizer actually supplied lesser amount of gas to well 3 than well 2. The result of the optimal distribution of the lift gas among the wells resulted in an increased in total oil production from 336 kg/sec (without economic objective) to 347.5 kg/sec (with economic objective) as shown in Figure 7. If the gas lift choke valve of well 5 is allowed to close down below 15%, there would probably be more increase in total oil production. However, shutting down a well completely is not a usual procedure and re-starting of a well after it has been shut down requires other tedious operations.

1) *Under input disturbance:* At time = 5 hrs, an input disturbance was given to the system by decreasing the supply gas from 40000 Sm<sup>3</sup>/hr to 36000 Sm<sup>3</sup>/hr as shown in Figure 8. Due to availability of lesser lift gas, the total oil production reduced and reached a steady state production of 328.5 kg/sec (see Figure 8(d)). It should however be noted that the reduction in the total oil production is still optimal in the case when economic objective is considered. The total oil production under the same input disturbance in the first case with only the control objective was only 317 kg/sec (see Figure 4(d)). This is less than 328.5 kg/sec (second case with both control and economic objectives) by 11.5 kg/sec. This comparatively shows that there is increase in total oil production even under the application of input disturbance. The percentage increase in

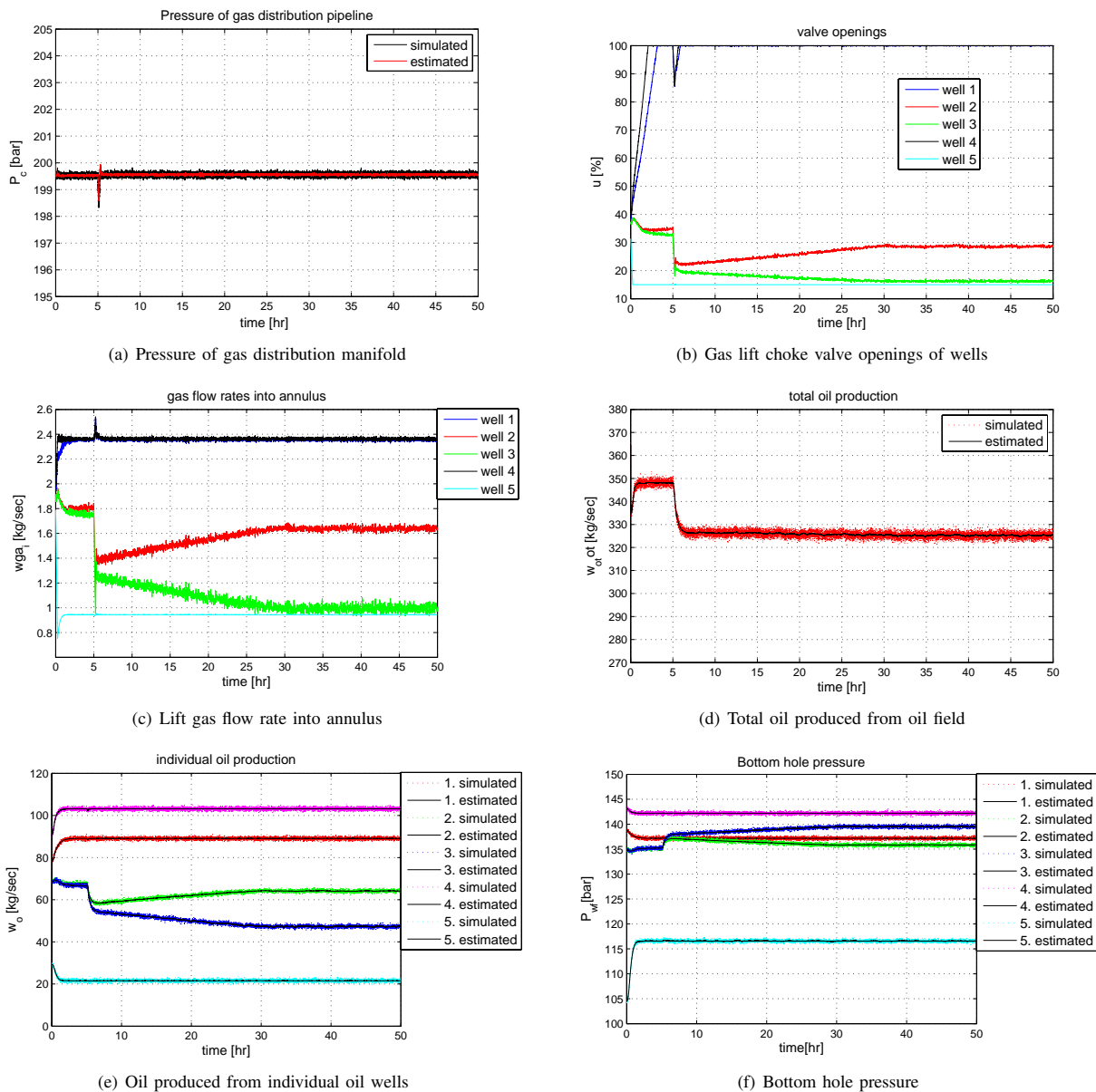

Fig. 8. Simulation results with both control and economic objectives and reduced supply of lift gas

the total oil production due to MPC acting as both as optimizer and controller is  $\frac{11.5}{336} \times 100\% = 3.4\%$ .

Along with acting as optimizer, MPC also fulfilled the task of tracking the pressure set point around 200 bar as shown in Figure 8(a). Due to the presence of economic objective along with the control objective in the same objective function of Equation 30, a compromise between the weighting factors of the two objectives has to be done. The weighting factors have been tuned in a way that both the objectives are well satisfied. There is a small steady state error of 0.5 bar in tracking the pressure set point. But at the same time, due to economic objective, there is an increase in total oil production by 3.4%. At simulation time = 5 hrs when the input disturbance was

applied, well 5 being a lower bounded active constraint did not take part in regulating the pressure of gas distribution pipeline. The other oil wells however manipulated their valves to track the pressure set point as shown in Figure 8(b). Upper bounded wells 4 and 1 temporarily reduced their valve openings to maintain the pressure. But once the pressure was maintained around 200 bar, the economic objective again forced them to climb to their upper bound of 100 % valve opening. Initially at time = 5 hrs, the valve openings of well 2 and well 3 were both reduced to maintain the control objective. However, due to the economic objective, the flow rate of gas injected into well 2 (with a slightly higher PI value than well 3) was then continuously increased. Similarly, the lift gas flow rate in well

TABLE II  
TOTAL OIL PRODUCTION

Gas supplied [ $\frac{Sm^3}{hr}$ ]	oil Produced [ $\frac{kg}{sec}$ ]		% increase
	control objective	control+economic objective	
40000	336	347.5	3.4%
44000	354	366	3.4%

3 was continuously decreased until a steady state was reached at time = 30 hrs.

The amount of oil produced by the individual oil wells is a function of the amount of gas injected into them and is shown in Figure 8(e). The amount of oil produced from wells 5, 2 and 3 were decreased and the oil productions from wells 1 and 4 were increased before the input disturbance was applied ( $0 \leq \text{time} \leq 5$  hrs). After the input disturbance was applied at time = 5 hrs, the amount of oil produced from well 4 and well 1 (both active at their upper bound) and from well 5 (active at its lower bound) were unaffected. The optimal reduction in oil production due to availability of reduced gas supply is due to the optimal reduction of oil produced from wells 2 and 3.

Similarly, when the supply of lift gas was increased to 44000  $Sm^3/hr$  from the nominal operating value at time = 4 hrs, the valve openings of well 2 and 3 increased to control the pressure as shown in Figure 9(a). Interestingly the valve opening of well 5 which was at its lower bound was also momentarily opened to meet the control objective but was again driven to its lower bound to fulfil the economic objective. The valve openings of well 4 and well 1 were already at 100% openings so the extra supplied gas of 4000  $Sm^3/hr$  was utilized by well 2 and 3 as shown in Figure 9(b). The total amount of oil produced from the oil field with only the control objective and with both control and economic objective is shown in Figure 10 and the results from simulation are listed in Table II.

As it can be seen from Figure 10, the total amount of oil produced when both economic and control objectives were used is greater by 3.4% than with only the control objective for normal supply of gas ( $0 \leq \text{time} \leq 4$  hrs) as well as for increased supply of gas (time > 4 hrs).

The analysis of the simulation results indicates the following for optimizing gas distribution in a gas lifted oil field:

Under the limited supply of lift gas, "For the oil wells with higher PI values, the gas lift choke valves should be fully opened in as many wells as possible. For the oil wells with lower PI values, the gas lift choke valves should be operated at their lower bounds in as few wells as possible". The generality of the results indicated above has not been further investigated in this paper.

### C. Estimation using UKF

In this paper, UKF was applied to estimate the bottom hole pressure of each oil wells. In many cases, the data obtained from the bottom hole sensors are not considered to be reliable due to harsh operating conditions of high temperature and pressure at the bottom of the oil well. UKF which is a nonlinear estimator was designed to overcome this difficulty.

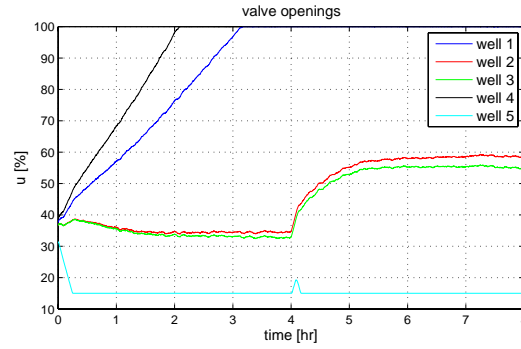

(a) Gas lift choke valve openings of each well

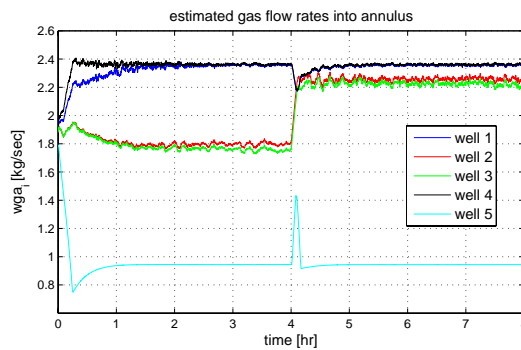

(b) Lift gas injection into each well

Fig. 9. Simulation results with both control and economic objectives and increased supply of lift gas

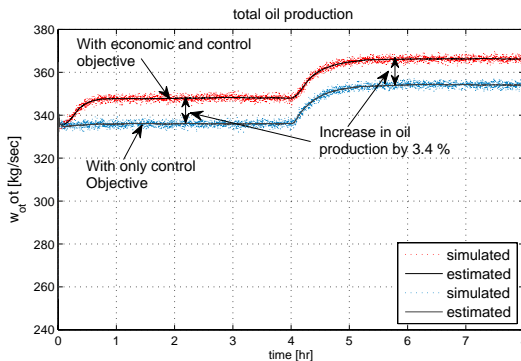

Fig. 10. Total oil productions with and without economic objective

The estimated bottom hole pressure of each oil wells is shown in Figure 8(f).

The estimated bottom hole pressure for all the oil wells closely followed the noisy simulated values. Since the MPC supplied lesser lift gas to well 5 ( $0 \leq \text{time} \leq 5$  hrs), its bottom hole pressure increased and remained constant after  $u_1^5$  became actively constrained at 15 % valve opening after the application of input disturbance ( reduced supply of lift gas) at time = 5 hrs as shown in Figure 8(f). Also after time  $\geq 5$  hrs, the bottom hole pressures of well 2 and 3 increased as lesser amount of lift gas was supplied to them due to input

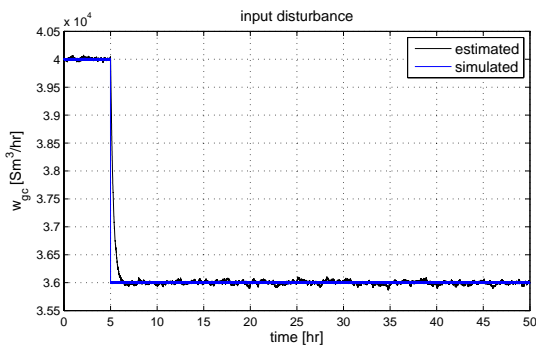

Fig. 11. Input disturbance estimation

disturbance. The bottom hole pressure of well 1 and well 4 initially ( $0 \leq \text{time} \leq 5$  hrs) decreased due to increased injection of the lift gas into them and then remained constant once their valve openings became actively constrained at their upper bound of 100%.

In many oil fields, Multiphase Flow Meter (MPM) are only installed on individual well heads. So the total lift gas supplied by the compressor which is considered to be the input disturbance to the process may not be measured. In such cases, UKF can be used for estimating it as shown in Figure 11. The simulation was started with a normal supply of lift gas i.e. with  $40000 \text{ Sm}^3/\text{hr}$  of lift gas supplied by the compressor. At time = 5 hrs (for the case when economic objective was also considered), input disturbance was applied i.e. the total gas supply was reduced to  $36000 \text{ Sm}^3/\text{hr}$ . As it can be seen from Figure 11, UKF was successfully used to estimate the input disturbance.

## VII. CONCLUSION

In general, a linear MPC is used for controlling process variables. In addition to controlling process variables, this paper shows that it can also be used for process optimization. A linear MPC consisting of both a control objective and an economic objective serves both as a controller and an optimizer. In particular, for the gas lifted oil field, we showed that adding an economic objective yields increased total oil production. The total oil production was increased by 3.4%. It must also be noted that, MPC solves a Quadratic Programming optimization problem at each time step so even the transient periods between steady states are also optimal in nature.

An Unscented Kalman Filter can be used to estimate the bottom hole pressure and the input disturbance. It must however be noted that UKF used in this paper also estimates the states of the system. For the model of the oil field, the states are the masses of gas and oil at different sections of the pipeline. Masses are usually measurable. If however, continuous measurement of masses in a dynamic process is tedious, then UKF can also be used for estimating them. UKF is easier to tune and implement than Extended Kalman Filter (EKF). It also eliminates the need to perform linearization at each sampling time unlike in EKF.

Moreover, in general, linear MPCs are more stable and robust compared to nonlinear MPCs. The findings of this paper might be helpful for all the gas lifted oil fields where the lift gas supply is limited and control and optimization is necessary.

## REFERENCES

- [1] G. Takacs, *Gas Lift Manual*. Tulsa, Oklahoma City: Pennwell Corporation, 2005.
- [2] H. Zhong, Y. Li, and Y. Liu, "An approach for optimization of gas-lift allocation to a group of wells and oil field," in *3rd International Symposium of National Key Laboratory for Oil and Gas Reservoir Exploitation*, Chengu, China, 2004, pp. 1–11.
- [3] V. D. Kosmidis, J. Perkins, and E. Pistikopoulos, "A mixed integer optimization formulation for the well scheduling problem on petroleum fields," *Journal of Computers and Chemical Engineering*, vol. 29, pp. 1523–1541, 2005.
- [4] E. Camponogara and P. H. R. Nakashima, "Solving a gas-lift optimization problem by dynamic programming," *European Journal of Operational Research*, vol. 174, pp. 1220–1246, 2006.
- [5] D. Saepudin, E. Soewono, K. Sidarto, A. Gunawan, S. Siregar, and P. Sukarno, "An investigation on gas lift performance curve in an oil producing well," *International Journal of Mathematics and Mathematical Science*, vol. 2007, pp. 1–15, 2007.
- [6] T. Ray and R. Sarker, "Genetic algorithm for solving a gas lift optimization problem," *Journal of Petroleum Science and Engineering*, vol. 59, pp. 84–96, 2007.
- [7] P. Sukarno, S. Saepudin, E. Soewono, K. Sidarto, and A. Gunawan, "Optimization of gas injection allocation in a dual gas lift well system," *Journal of Energy Resources Technology*, vol. 131, Issue 3, 2009.
- [8] K. Rashid, "Optimal allocation procedure for gas-lifted optimization," *Industrial and Engineering Chemistry Research*, vol. 49, pp. 2286–2294, 2010.
- [9] A. Plucenio, D. Pagano, E. Camponogara, A. Trappe, and A. Teixeira, "Gas-lift optimization and control with nonlinear mpc," vol. 7, no. 1. Koc University Campus, Turkey: 7th IFAC International Symposium on Advanced Control of Chemical Processes, Jul 12-15 2009.
- [10] R. Sharma, K. Fjalestad, and B. Glemmestad, "Modeling and control of gas lifted oil field with five oil wells." Västerås, Sweden: 52nd International Conference of Scandinavian Simulation Society, SIMS 2011, Sep 29-30 2011, pp. 47–59, ISBN: 978-91-977493-7-4.
- [11] ANSI/ISA.S75.01, *Flow Equations for Sizing Control Valves, Standards and Recommended Practices for Instrumentation and Control*, 10th ed., 1989.
- [12] PVTsim, "Pvt simulation program developed for reservoir engineers, flow assurance specialists, pvt lab engineers and process engineers [online]." Available at: <http://www.pvtsim.com> (Accessed: 20 January 2011), 2008.
- [13] K. E. Brown and H. D. Beggs, *The technology of artificial lift methods, Volume 1, Inflow Performance, Multiphase flow in pipes, The flowing well*. Tulsa, Oklahoma, ISBN: 0-87814-031-X: PennWell Publishing Company, 1977.
- [14] American.Petroleum.Institute, *API gas lift manual, Book 6 of the Vocational Training series*, third edition ed. Washington DC 2005-4070, USA: Exploration and Production Department, 1994.
- [15] D. Simon, *Optimal State Estimation: Kalman, Hinf and nonlinear approaches*. Hoboken, New Jersey: John Wiley & Sons, Inc., Publication, 2006, ISBN: 13 978-0-471-70858-2.
- [16] D. D. Ruscio and B. Foss, "On model based predictive control." Corfu, Greece: The 5th IFAC Symposium on Dynamics and Control of Process Systems, June 8-10 1998.