

On the Exact Solution of Non-Uniform Torsion for Beams with Axial Symmetric Cross-Section

A. Campanile, M. Mandarino, V. Piscopo, A. Pranzitelli

Abstract—In the traditional theory of non-uniform torsion the axial displacement field is expressed as the product of the unit twist angle and the warping function. The first one, variable along the beam axis, is obtained by a global congruence condition; the second one, instead, defined over the cross-section, is determined by solving a Neumann problem associated to the Laplace equation, as well as for the uniform torsion problem.

So, as in the classical theory the warping function doesn't punctually satisfy the first indefinite equilibrium equation, the principal aim of this work is to develop a new theory for non-uniform torsion of beams with axial symmetric cross-section, fully restrained on both ends and loaded by a constant torque, that permits to punctually satisfy the previous equation, by means of a trigonometric expansion of the axial displacement and unit twist angle functions.

Furthermore, as the classical theory is generally applied with good results to the global and local analysis of ship structures, two beams having the first one an open profile, the second one a closed section, have been analyzed, in order to compare the two theories.

Keywords—Non-uniform torsion, Axial symmetric cross-section, Fourier series, Helmholtz equation, FE method.

I. INTRODUCTION

It's well known that the Saint Venant's theory for uniform linear torsion gives an exact solution for prismatic bars under constant torque if the displacement gradients are small and the end cross-sections are free to warp. In this case, in fact, assuming that the warping displacement varies over the cross-section but remains constant along the beam length, there are no secondary warping stresses. On the contrary, if the beam ends are not free to warp or if the external applied torque is not constant along the beam length, it is not possible to apply directly the Saint Venant's theory, as secondary axial and tangential stresses, due to the non-uniform torsion problem, arise.

Approximate theories for thin-walled elastic beams, assimilable to long prismatic shells and characterized by a

A. Campanile is Full Professor at the University of Naples "Federico II", Department of Naval Architecture and Marine Engineering, Via Claudio 21 80125 Napoli Italy (phone: +39-081-7683710; fax: +39-081-2390380; e-mail: campanil@unina.it).

M. Mandarino is Full Professor at the University of Naples "Federico II", Department of Naval Architecture and Marine Engineering, Via Claudio 21 80125 Napoli Italy (phone: +39-081-7683701; fax: +39-081-2390380; e-mail: mandarin@unina.it).

V. Piscopo is a third year Ph.D. student at the University of Naples "Federico II", Department of Naval Architecture and Marine Engineering, Via Claudio 21 80125 Napoli Italy (fax: +39-081-2390380; e-mail: vincenzo.piscopo@unina.it).

A. Pranzitelli is a graduated Ph.D. at the University of Naples "Federico II", Department of Naval Architecture and Marine Engineering, Via Claudio 21 80125 Napoli Italy (fax: +39-081-2390380; e-mail: alessandro.pranzitelli@inwind.it).

triple order of dimensions:

- 1) plate thickness;
- 2) mean dimension of the cross-section;
- 3) beam length,

the first one negligible respect to the other two ones, have been examined by Timoshenko, Goodier, Vlasov and others. All these theories are substantially based on the subdivision of the tangential stress flow, produced by the applied twist moment, into two parts: the primary and the secondary one. The primary flow, typical of Saint-Venant's theory, is associated to the so-called pure torsion; the secondary one, instead, is associated to the tangential stress field connected, for the equilibrium, to the normal one caused by a non-uniform warping of the beam cross-section. Concerning the warping function, it doesn't punctually satisfy the first indefinite equilibrium equation over the beam cross-section, but only a global congruence condition is respected.

So, in the following, the problem of the elastic equilibrium of beams subjected to non-uniform torsion with axial symmetric cross-section, is discussed from the beginning, trying to eliminate the assumptions typical of the classical theories.

II. THEORY DEVELOPMENT

Let us assume that the beam cross-section, having two symmetry axes, rotates undeformed through a small angle $\vartheta_i(x)$ about the centroidal axis x and warps out of its plane. Let us define the global Cartesian frames sketched in Fig. 1, with origin O in correspondence of the left beam end, x axis defined along the beam length and passing through the section centroid and η, ζ axes defined in the section plane and coinciding with the section principal axes of inertia.

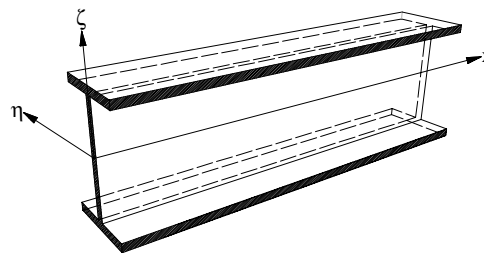

Fig. 1 Reference Coordinate system

In the hypothesis of non-uniform torsion, denoting by u, v, w the three displacement components in the x, η, ζ directions respectively, the displacement field can be assumed as follows:

$$\begin{cases} u = \tilde{u}(x, \eta, \zeta) \\ v = -\vartheta_1(x)\zeta \\ w = \vartheta_1(x)\eta \end{cases} \quad (1)$$

where $\tilde{u}(x, \eta, \zeta)$ is the axial displacement function and $\vartheta_1(x)$ is the rotation of the section around the x -axis, positive if counter-clockwise.

With the previous assumptions and notations, the strain components (for small deformation) are then given by:

$$\begin{cases} \varepsilon_x = \frac{\partial \tilde{u}}{\partial x} \\ \varepsilon_y = 0 \\ \varepsilon_z = 0 \end{cases} \quad (2.1)$$

$$\begin{cases} \gamma_{xy} = \frac{\partial \tilde{u}}{\partial \eta} - \vartheta_1 \zeta \\ \gamma_{xz} = \frac{\partial \tilde{u}}{\partial \zeta} + \vartheta_1 \eta \\ \gamma_{yz} = 0 \end{cases} \quad (2.2)$$

having defined the unit twist angle as follows:

$$\vartheta_1 = \frac{d\vartheta_1}{dx} \quad (2.3)$$

Denoting by E the Young modulus, G the Coulomb modulus and ν the Poisson modulus, the Navier equations can be so specialized:

$$\begin{cases} \sigma_x = E \frac{\partial \tilde{u}}{\partial x} \\ \tau_{xy} = G \left[\frac{\partial \tilde{u}}{\partial \eta} - \zeta \vartheta_1 \right] \\ \tau_{xz} = G \left[\frac{\partial \tilde{u}}{\partial \zeta} + \eta \vartheta_1 \right] \end{cases} \quad (3)$$

As regards the expression (3)₁, it derives by assuming as anelastic tensions σ_y in the web, σ_z in the flanges, what allows to reduce the (3)₁ coefficient to the ratio $\frac{E}{1-\nu^2} \equiv E$.

Concerning the indefinite equilibrium equations, which naturally involve all the stress components, they can be rewritten neglecting the body forces and the pressure loads. The system of the indefinite and boundary equilibrium equations becomes:

$$\begin{cases} \text{div } \Sigma = 0 \\ \Sigma \mathbf{n} = 0 \end{cases} \quad (4)$$

where Σ is the stress tensor and \mathbf{n} is the unit vector normal to the section boundary (positive outwards).

Concerning the indefinite equilibrium equations, it is not necessary to satisfy punctually the ones in the transverse directions, as the only relevant scalar equations, in the beam theory, are the x -projections of the vectorial (4). In the further hypothesis of cylindrical body, assuming $\mathbf{n} \cdot \mathbf{i} = 0$, the equilibrium conditions inside the body and on the boundary can be so rewritten:

$$\begin{cases} \frac{\partial \tau_{xy}}{\partial \eta} + \frac{\partial \tau_{xz}}{\partial \zeta} = -\frac{\partial \sigma_x}{\partial x} \quad \forall P \in \overset{\circ}{A} \\ \tau_{xn} = 0 \quad \forall P \in Fr(A) \end{cases} \quad (5)$$

having denoted by A the cross-section domain and by τ_{xn} the tangential stress component, normal to the boundary.

Furthermore, as the axial stress field must be equivalent to zero, the following global conditions have to be satisfied:

$$\begin{cases} \int_A \sigma_x dA = 0 \\ \int_A \sigma_x \eta dA = 0 \\ \int_A \sigma_x \zeta dA = 0 \end{cases} \quad (6)$$

Particularly, in this case thanks to the section double symmetry, the axial displacement function will be anti-symmetric as regards the η, ζ axes and all the equations (6) will be automatically satisfied.

Furthermore, unlike the traditional theory of non-uniform torsion, where the warping function remains determined by a Neumann boundary problem associated to the Laplace equation, in the following the previously defined differential problem (5) will be fully satisfied, without any simplification. To fully define the non-uniform torsion problem, it is also necessary to impose, for the axial displacement and unit twist angle functions, the relative boundary conditions at the two beam ends. Assuming that the warping is totally restrained on both ends, the differential problem, in terms of displacements, becomes:

$$\begin{cases} \frac{\partial^2 \tilde{u}}{\partial \eta^2} + \frac{\partial^2 \tilde{u}}{\partial \zeta^2} = -2(1+\nu) \frac{\partial^2 \tilde{u}}{\partial x^2} \quad \forall P \in \overset{\circ}{A} \\ \frac{\partial \tilde{u}}{\partial n} = -\vartheta_1 (\eta \alpha_{nz} - \zeta \alpha_{ny}) \quad \forall P \in Fr(A) \\ \tilde{u}(0, \eta, \zeta) = \tilde{u}(L, \eta, \zeta) = 0; \vartheta_1(0) = \vartheta_1(L) = 0 \end{cases} \quad (7)$$

having denoted by α_{ny} and α_{nz} the director cosines of the unit normal vector, positive if outwards, and by L the beam length. In order to solve the problem (7) the axial displacement function and the unit twist angle are preliminarily expanded

into appropriate trigonometric series, reduced to their M-partial sums, as follows:

$$\begin{cases} \tilde{u}(x, \eta, \zeta) = \sum_{m=1}^M W_m(\eta, \zeta) \sin \frac{m\pi x}{L} \\ \vartheta_1(x) = \sum_{m=1}^M \Omega_m \sin \frac{m\pi x}{L} \end{cases} \quad (8)$$

It's noticed that the general series terms automatically satisfy the third and the fourth of (7) $\forall m=1 \dots M$.

Taking into account that for any Ω_m equal to zero, also $W_m(\eta, \zeta)$ will be zero, for nonzero Ω_m it is possible to introduce another unknown function $f_m(\eta, \zeta)$ so defined:

$$f_m(\eta, \zeta) = \frac{W_m(\eta, \zeta)}{\Omega_m} \quad (9)$$

By (8) and (9) the first two equations of (7) can be rewritten as follows:

$$\begin{cases} \nabla^2 f_m = 2(1+\nu) \frac{m^2 \pi^2}{L^2} f_m \quad \forall P \in \overset{\circ}{A} \\ \frac{\partial f_m}{\partial n} = \zeta \alpha_{ny} - \eta \alpha_{nz} \quad \forall P \in Fr(A) \end{cases} \quad (10)$$

so that $\forall m=1 \dots M$ $f_m(\eta, \zeta)$ will be solution of a Neumann boundary problem associated to the pure Helmholtz equation (see [3]).

Since it is not possible to find an analytical solution of the problem (10) for a generic beam cross-section, it is necessary to resort to numerical methods to solve it. In this work the Finite Element Method (FEM) is adopted, by means of the Mathworks Matlab software. To solve this problem for an assigned beam section and for the varying harmonics' index m , it is needed to realize a suitable script file. The computational domain is subdivided by a triangular mesh, made up of an enough large number of elements and the partial differential equation is discretized on it. The solution $f_m(\eta, \zeta)$ is calculated at the vertices of the triangles (i.e. the nodes of the mesh) and it is assumed to vary linearly on each triangle, obtaining a continuous piecewise linear function on the mesh. Its first derivatives, as regards the η and ζ axes, instead are evaluated in correspondence of the centre of each triangle.

Finally, to determine uniquely the solution, it is necessary to find the unknown coefficient Ω_m . The generalized twist moment sectional force can be so expressed:

$$M_t(x) = \int_A [\tau_{xz} \eta - \tau_{xy} \zeta] dA \quad (11)$$

finally becoming:

$$M_t(x) = GI_p \vartheta_1 + G \int_A \left[\frac{\partial \tilde{u}}{\partial \zeta} \eta - \frac{\partial \tilde{u}}{\partial \eta} \zeta \right] dA \quad (12)$$

having done the following position:

$$I_p = \int_A [\eta^2 + \zeta^2] dA \quad (13)$$

By (8), (9) and (13), the eq. (12) becomes:

$$M_t(x) = GI_p \sum_{m=1}^M \Omega_m \sin \frac{m\pi x}{L} + G \sum_{m=1}^M \Omega_m H_m \sin \frac{m\pi x}{L} \quad (14)$$

having done the position:

$$H_m = \int_A \left[\eta \frac{\partial f_m}{\partial \zeta} - \zeta \frac{\partial f_m}{\partial \eta} \right] dA \quad (15)$$

Then, thanks to the orthogonality of the trigonometric functions, it is possible to determine the unknown coefficient Ω_m as follows:

$$\Omega_m = \frac{2 \int_0^L \left[M_t(x) \sin \frac{m\pi x}{L} \right] dx}{GL(I_p + H_m)} \quad (16)$$

Particularly, if $M_t(x) = M_t = const.$ the eq. (16) can be so specialized:

$$\Omega_m = \frac{2M_t}{G(I_p + H_m)} \cdot \frac{1 - \cos m\pi}{m\pi} \quad (17)$$

Concerning the bimoment, its generalized expression can be written as follows:

$$B = \sum_{m=1}^M B_m = \sum_{m=1}^M \int_A \sigma_{x-m} \cdot f_m dA \quad (18)$$

So, defining preliminarily the warping modulus I_{w-m} relative to the m -harmonic:

$$I_{w-m} = \int_A f_m^2 dA \quad (19)$$

the eq. (18) and the stress field, similarly to the Vlasov's theory, become:

$$B = \frac{4(1+\nu)M_t}{L} \sum_{m=1}^M \frac{1 - \cos m\pi}{I_p + H_m} \cos \frac{m\pi x}{L} I_{w-m} \quad (20)$$

$$\left\{ \begin{aligned} \sigma_x &= \sum_{m=1}^M \frac{B_m}{I_{w-m}} f_m(\eta, \zeta) \\ \tau_{xy} &= 2M_t \sum_{m=1}^M \frac{1 - \cos m\pi}{m\pi} \frac{\frac{\partial f_m}{\partial \eta} - \zeta}{I_p + H_m} \sin \frac{m\pi x}{L} \\ \tau_{xz} &= 2M_t \sum_{m=1}^M \frac{1 - \cos m\pi}{m\pi} \frac{\frac{\partial f_m}{\partial \zeta} + \eta}{I_p + H_m} \sin \frac{m\pi x}{L} \end{aligned} \right. \quad (21)$$

III. BEAM WITH MONOCONNECTED CROSS-SECTION

In order to verify the goodness of the applied theory, an application has been carried out for a beam already analyzed by C.J. Burgoyne and H. Brown (see [4]), falling indisputably within the thin-wall domain. The aims of this application are:

1. to verify the goodness of the applied FE method by a numerical comparison with the results presented in [4];
2. to verify the convergence of the solution when the number of harmonics increases;
3. to make a comparison on the unit-twist angle and bimoment longitudinal distribution with the classical approximate theories for thin-walled elastic beams.

In the following figure the section scheme is shown (all dimensions are in mm).

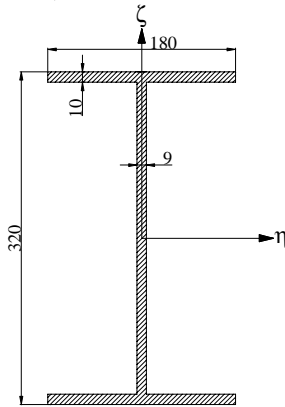

Fig. 2 Cross-section scheme

In the analysis the other useful data are:

- Poisson modulus ν 0.3
- Beam length L 6.40 m
- Polar moment of inertia I_p 1.165082 E-4 m⁴

In table I a numerical comparison for the first eight harmonics is shown, from which it is possible to verify that a good agreement with the results presented in [4] is obtained for each harmonic. In the analysis a fine mesh with 24576 elements has been adopted. In table II, instead, the number of triangles defining the mesh has been varied, verifying for the first eight harmonics that, increasing the harmonics' index, the influence of the elements' number on the results becomes almost totally negligible, while it is considerable for the first ones.

TABLE I
A NUMERICAL COMPARISON

m	Burgoyne (x_B)	Present - 24576 (x_P)	$\frac{x_P - x_B}{x_B} \cdot 100$
	$I_p + H_m$	$I_p + H_m$	
1	3.38271E-07	3.40222E-07	0.577
2	7.72486E-07	7.74252E-07	0.229
3	1.48478E-06	1.48627E-06	0.100
4	2.45891E-06	2.45991E-06	0.041
5	3.67306E-06	3.67363E-06	0.016
6	5.10185E-06	5.10178E-06	-0.001
7	6.71581E-06	6.71599E-06	0.003
8	8.48654E-06	8.48635E-06	-0.002

TABLE II
INFLUENCE OF THE MESH

m	Elements' number		$\frac{x_{96} - x_P}{x_P} \cdot 100$	$\frac{x_{1536} - x_P}{x_P} \cdot 100$
	96 (x_{96})	1536 (x_{1536})		
	$I_p + H_m$	$I_p + H_m$		
1	5.795036E-07	3.553103E-07	70.331	4.435
2	1.014460E-06	7.893310E-07	31.025	1.948
3	1.728168E-06	1.501353E-06	16.276	1.015
4	2.704480E-06	2.475059E-06	9.942	0.616
5	3.922079E-06	3.688922E-06	6.763	0.416
6	5.355607E-06	5.117364E-06	4.975	0.305
7	6.976913E-06	6.732032E-06	3.885	0.239
8	8.756320E-06	8.503078E-06	3.181	0.197

In Fig.3 and Fig.4 it is also shown, increasing the harmonics' number, the convergence behaviour of the unit twist angle function, evaluated at $x = 0.1$ m and $x = 3.2$ m, as this parameter is the most representative one in the study of non-uniform torsion. All the presented results are relative to a mesh with 24576 elements; the applied torque has been assumed unitary. In this case it is possible to verify that 100 harmonics are substantially sufficient to obtain a consistent result.

It seems also useful a comparison with the classical Vlasov's theory for thin-walled elastic beams. Concerning the unit twist angle longitudinal distribution, in the classical theory it can be evaluated by the following differential equation, obtained by a global congruence condition:

$$GI_t \vartheta_1 - EI_w \frac{d^2 \vartheta_1}{dx^2} = M_t \quad (22)$$

to which the following boundary conditions must be added:

$$\begin{cases} \vartheta_1(0) = 0 \\ \vartheta_1(L) = 0 \end{cases} \quad (23)$$

In eq. (22) I_t is the DSV torsional coefficient while I_w is the beam warping coefficient. Starting from the position:

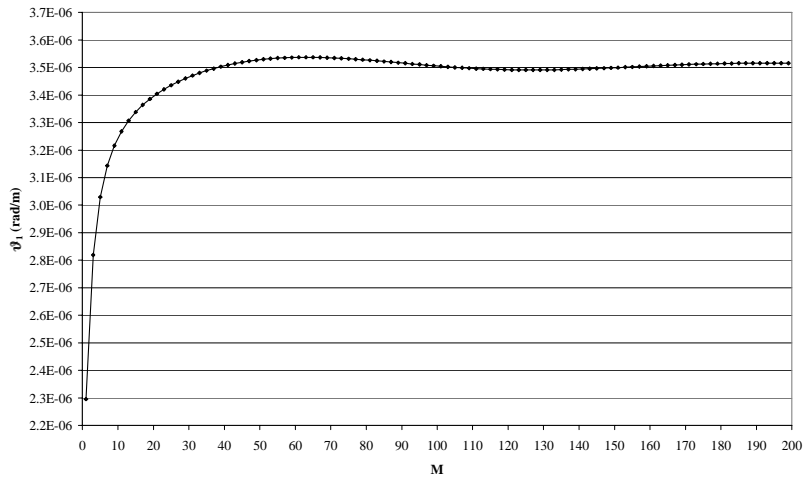

Fig. 3 Unit twist angle convergence $x = 0.1$ m

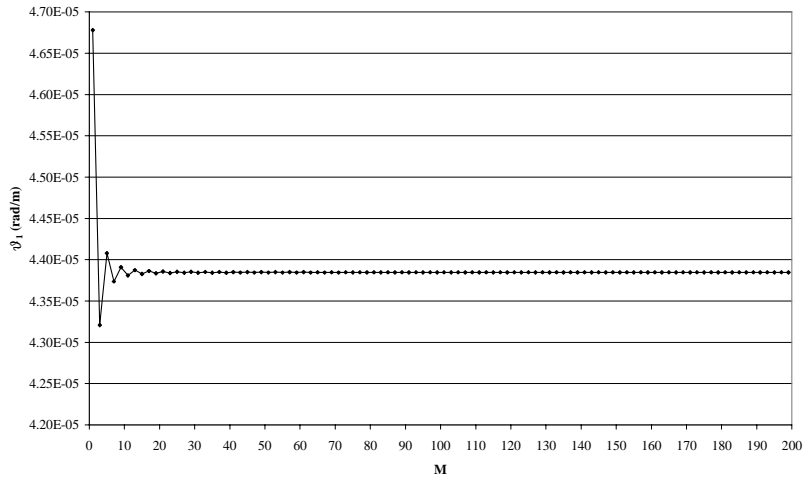

Fig. 4 Unit twist angle convergence $x = 3.2$ m

$$\beta = \frac{GI_t}{EI_w} \quad (24)$$

For monoconnected thin-walled beams the following approximate expression can be adopted for the beam torsional coefficient:

the general solution of eq. (22) is:

$$\vartheta_1 = A_1 \cosh(\sqrt{\beta}x) + A_2 \sinh(\sqrt{\beta}x) + \vartheta_p(x) \quad (25)$$

$$I_t = \frac{1}{3} \sum_{i=1}^N l_i t_i^3 = 1.9533E-07 \text{ m}^4 \quad (28)$$

where $\vartheta_p(x)$ represents its particular solution that, for a constant applied torque, becomes:

$$\vartheta_p(x) = \frac{M_t}{GI_t} \quad (26)$$

having denoted respectively by l_i and t_i the length and the thickness of each branch constituting the beam cross-section. As regards the warping coefficient, for thin-walled I beams, subjected to non-uniform torsion, the following approximate expression can be adopted (e.g. [6]):

The final expression of the unit twist angle will be:

$$I_w = \frac{1}{24} l_{i-WEB} \cdot l_{i-FLANGE}^3 \cdot t_{i-FLANGE} = 2.3352E-07 \text{ m}^4 \quad (29)$$

$$\vartheta_1 = \frac{M_t}{GI_t} \left[1 - \cosh(\sqrt{\beta}x) - \frac{1 - \cosh(\sqrt{\beta}L)}{\sinh(\sqrt{\beta}L)} \sinh(\sqrt{\beta}x) \right] \quad (27)$$

Concerning the bimoment distribution, in the classical theory it is defined as follows:

$$B = EI_w \frac{d\vartheta_1}{dx} \tag{30}$$

from which, for $M_t(x) = M_t = const.$, it is obtained:

$$B = -\frac{M_t}{\sqrt{\beta}} \left[\sinh(\sqrt{\beta}x) + \frac{1 - \cosh(\sqrt{\beta}L)}{\sinh(\sqrt{\beta}L)} \cosh(\sqrt{\beta}x) \right] \tag{31}$$

In Fig. 5 and Fig. 6 the unit twist angle and bimoment longitudinal distributions are shown for a unitary applied torque. In this case no appreciable differences between the two theories have been noticed.

Finally, in table III, the warping stresses in some chosen points of the cross-section in correspondence of the left beam end have been evaluated, verifying also in this case that a good convergence is achieved into a low harmonics' number (see also Fig. 8). Furthermore, a good agreement with the classical theory is also obtained, according to which the warping stresses can be written as follows:

$$\sigma_x = E \frac{d\vartheta_1}{dx} \omega(\eta, \zeta) \tag{32}$$

where $\omega(\eta, \zeta) = f_0(\eta, \zeta)$ is the classical warping function, solution of a the Neumann problem (10) with $m=0$.

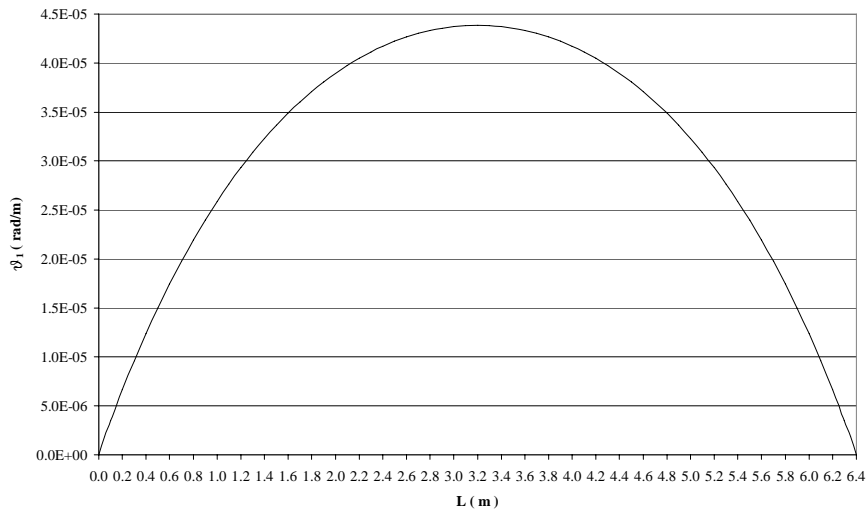

Fig. 5 Unit twist angle longitudinal distribution

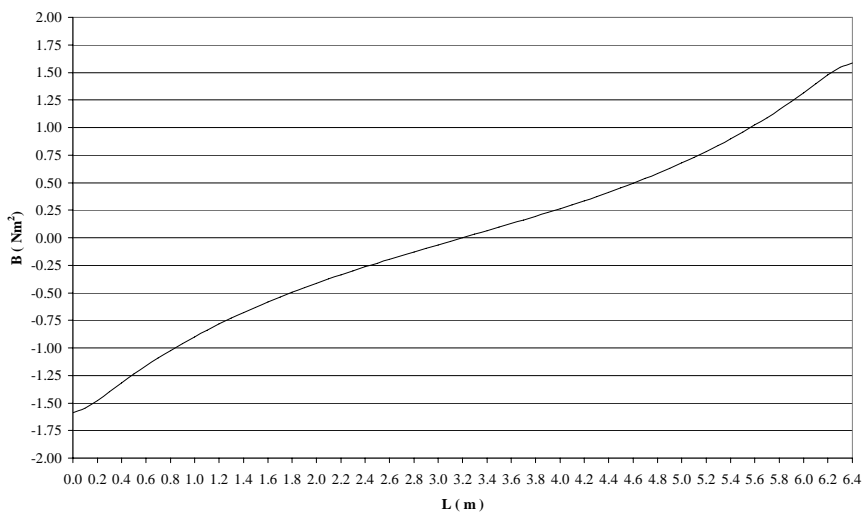

Fig. 6 Bimoment longitudinal distribution

TABLE III
WARPING STRESSES DISTRIBUTION

η	ζ	$\sigma_{x-classical}$	$\sigma_{x-exact}$	$\frac{\sigma_{x-classical} - \sigma_{x-exact}}{\sigma_{x-exact}} \cdot 100$
m	m	N/mm ²	N/mm ²	%
0.09	0.155	0.09959	0.10213	-2.487
0.07	0.155	0.07762	0.07714	0.622
0.05	0.155	0.05542	0.05439	1.894
0.03	0.155	0.03322	0.03242	2.468
0.01	0.155	0.01103	0.01082	1.941
0	0.155	0	0	---

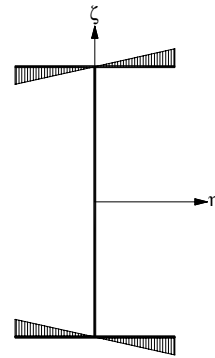

Fig. 7 Warping stresses distribution

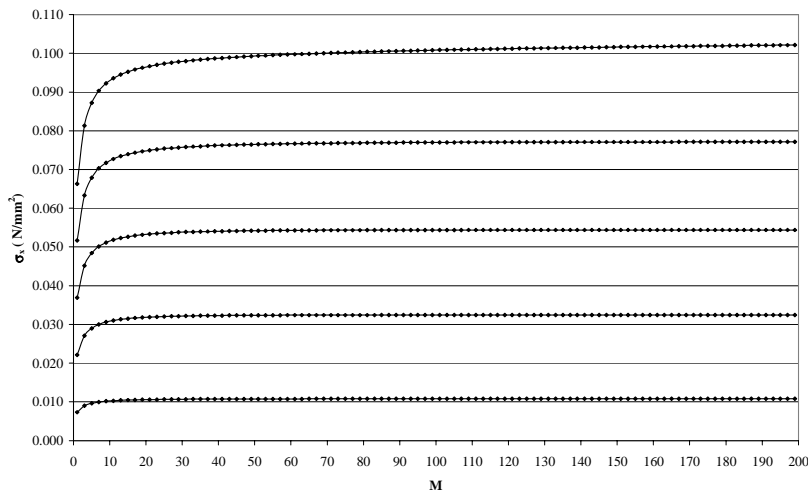

Fig. 8 Warping stresses convergence

IV. BEAM WITH BICONNECTED CROSS-SECTION

In order to verify the feasibility of the applied theory and to compare it with the classical one, it seems useful to carry out another application, relative to a beam with a closed cross section, with $\nu=0.3$, $L=10$ m and $I_p=1.911787 \text{ E-2 m}^4$. In the following figure the section scheme is shown (all dimensions are in mm).

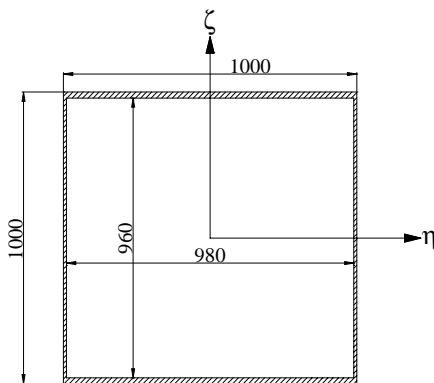

Fig. 9 Cross-section scheme

In Fig. 10 and Fig. 11 it is shown, increasing the harmonics' number, the convergence behaviour of the unit twist angle function evaluated at $x = 0.1$ m and $x = 5.0$ m. All the presented results are relative to a mesh with 11136 elements; the applied torque has been assumed equal to 1 kNm.

In this case it is possible to verify that while far away from the beam ends 200 harmonics are sufficient to obtain a consistent result, near the supports the minimum necessary number to obtain a good convergence is much higher (at least 1000 harmonics).

Concerning the classical theory, preliminarily it is possible to verify that for a beam with multiconnected cross section the torsional and warping modulus can be so expressed:

$$I_t = I_p - I_{h\partial\omega} \tag{33}$$

$$I_w = I_{\omega\omega} \tag{34}$$

having done the following positions:

$$I_{h\partial\omega} = \int_A h(s) \frac{\partial\omega}{\partial s} dA ; I_{\omega\omega} = \int_A \omega^2 dA \tag{35}$$

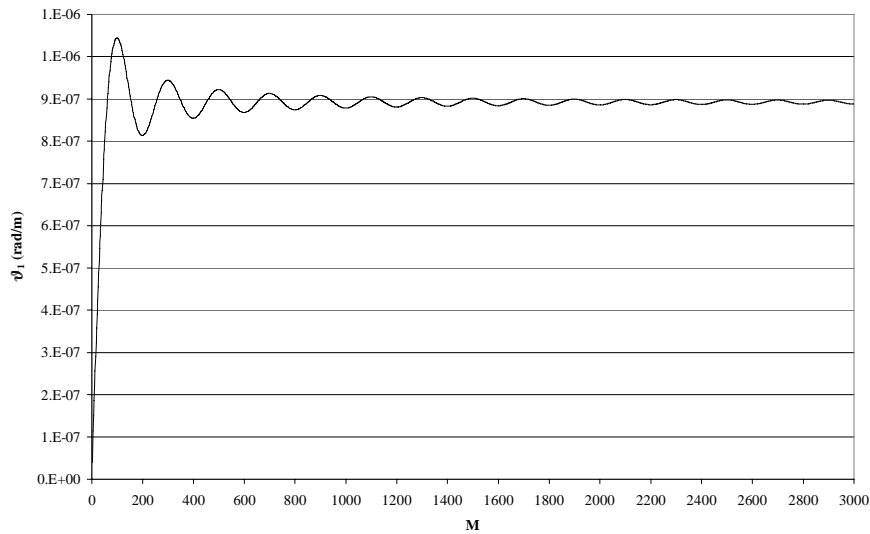

Fig. 10 Unit twist angle convergence x = 0.1 m

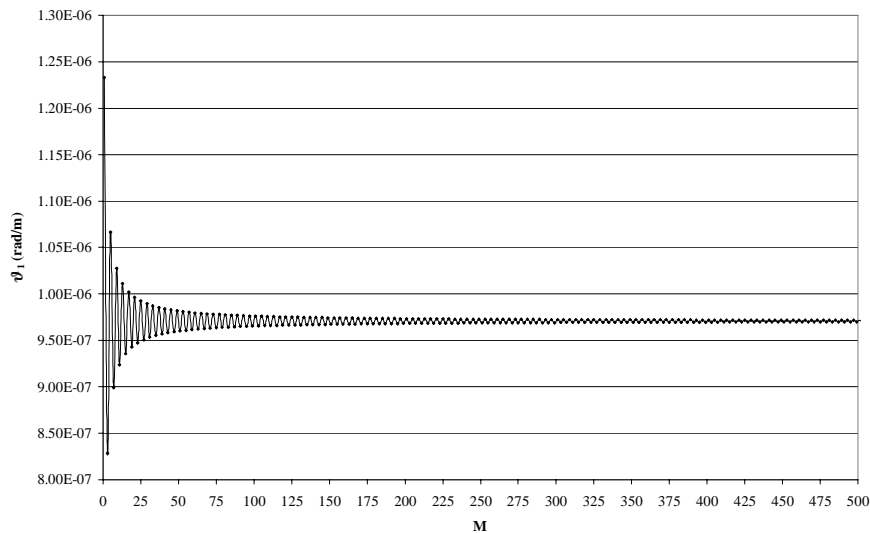

Fig. 11 Unit twist angle convergence x = 5.0 m

Introducing, for each branch, a local coordinate system and denoting by s the curvilinear abscissa with reference on the centre line, with the O origin in either extremity (node) of the line, the function $h(s)$ for each branch becomes:

$$h(s) = \eta\alpha_{sz} - \zeta\alpha_{sy} \tag{36}$$

while the warping function $\omega(s, n)$ is, in this case, derived by a stationary problem associate to the Laplace equation with Neumann boundary condition. The obtained values are: $I_i = 1.276323 \text{ E-2 m}^4$; $I_w = 1.255170 \text{ E-4 m}^6$.

In Fig. 12 and 13, assuming an applied torque equal to 1 kNm, the unit twist angle and the bimoment longitudinal

distributions are shown: the dashed and continuous lines refer, to the classical and exact theories, respectively. From the diagrams it is possible to verify that some appreciable differences between the two theories arise, especially near the supports where the warping is totally restrained.

Finally, in table IV, a numerical comparison on the warping stresses in some chosen points of the section in correspondence of the beam left support, has been carried out, verifying that near the extremity nodes of each branch, where the warping stresses become maximum, the classical theory generally underestimates them of about 20%.

In Fig. 14 the warping stress distribution is shown: the dashed and continuous lines refer to the classical and exact theories, respectively.

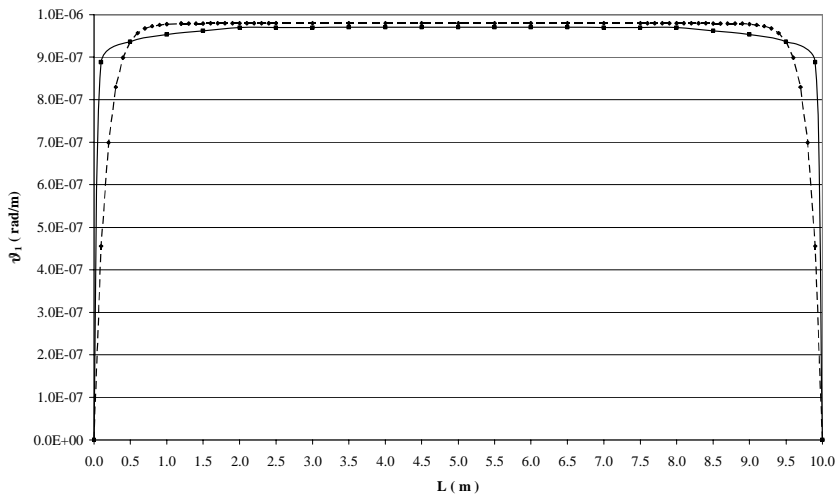

Fig. 12 Unit twist angle longitudinal distribution

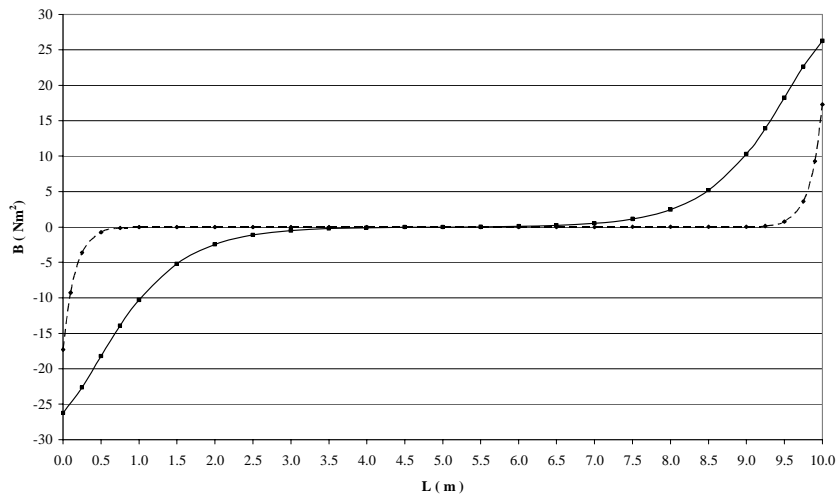

Fig. 13 Bimoment longitudinal distribution

TABLE IV
WARPING STRESSES DISTRIBUTION

η m	ζ m	$\sigma_{x-classical}$ N/mm ²	$\sigma_{x-exact}$ N/mm ²	$\frac{\sigma_{x-classical} - \sigma_{x-exact}}{\sigma_{x-exact}} \cdot 100$
0.000	0.490	0.0000E+00	0.0000E+00	---
0.100	0.490	6.7492E-03	3.9350E-03	71.52
0.200	0.490	1.3498E-02	8.2457E-03	63.70
0.300	0.490	2.0248E-02	1.3688E-02	47.93
0.400	0.490	2.6997E-02	2.2139E-02	21.94
0.450	0.490	3.0371E-02	2.9764E-02	2.04
0.495	0.490	3.3408E-02	4.2787E-02	-21.92

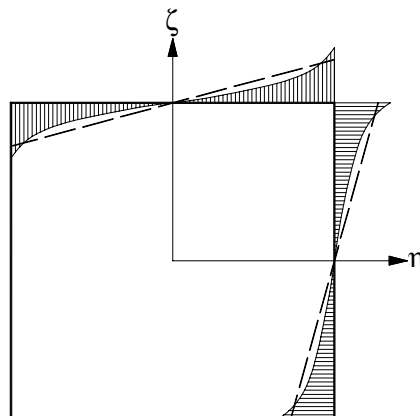

Fig. 14 Warping stresses distribution

V. CONCLUSIONS

A new theory for non uniform torsion in beams with axial-symmetric cross-section has been adopted. The theory, substantially based on the Fourier development of the warping displacement and unit twist angle functions, permits to fully respect the first indefinite equilibrium equation, despite of the classical one.

Particularly two applications have been carried out: the first one, relative to a beam with open cross-section; the second one, instead, relative to a beam with closed cross-section.

As regards the first application, the two theories have a very good agreement in the unit twist angle and bimoment longitudinal distribution. The warping stress distribution over the cross-section is substantially the same, too.

As regards the beam with closed cross section, instead, it has been verified that near the supports appreciable differences on the unit twist angle and bimoment between the two theories, arise. Furthermore, applying the exact theory, it has been verified that the warping stress distribution over the cross-section is not linear, as it is admitted in the classical theory for thin-walled elastic beams.

Obviously the exact theory can be also extended to beams with a generic cross section: this problem and the relative comparisons with the classical theory, will be the subjects of another work.

REFERENCES

- [1] R. Fiorenza, *Appunti delle lezioni di Analisi Funzionale*, Gli Strumenti di Coinor, 2005.
- [2] V. Vlasov, *Thin-walled elastic beams*, Jerusalem: Israel program for Scientific Translation Ltd, 1961.
- [3] A.D. Polyamin, *Linear partial differential equations for Engineers and Scientists*, CHAPMAN & HALL/CRC.
- [4] C.J. Burgoyne, H. Brown, "Non uniform elastic torsion", *International Journal of Mechanical Sciences*, Vol. 36, No. 1, pp. 23-38, 1994.
- [5] T. Coppola, E. Fasano, M. Mandarino, A. Turtoro, "The restrained warping applied to catamarans", *Fast '97 Papers*, 1997.
- [6] K. Haslum, A. Tonnensen, "An analysis of torsion in ship hulls", *European Shipbuilding*, No. 5/6, pp. 67-90, 1972.

A. Campanile. Full Professor of Offshore Structures at the University of Naples "Federico II" since 1990, SNAME Member, Degree in Naval and Mechanical Engineering in 1971.

M. Mandarino. Full Professor since 1990, Associate Professor in 1980, Masters Degree in Naval Architecture, Marine and Mechanical Engineering in 1974.

V. Piscopo. Third year Ph.D. student at the University of Naples "Federico II", First Degree in Naval Engineering in 2004, Second Degree in Naval Engineering in 2006.

A. Pranzitelli. Degree in Aerospace Engineering in 2005, Ph.D. in 2008 at the University of Naples "Federico II". At present he collaborates with the Department of Aerospace Engineering of the same University on Computational Fluid Dynamics for both aeronautical and naval applications.