

On the AC-Side Interface Filter in Three-Phase Shunt Active Power Filter Systems

Mihaela Popescu, Alexandru Bitoleanu, and Mircea Dobriceanu

Abstract—The proper selection of the AC-side passive filter interconnecting the voltage source converter to the power supply is essential to obtain satisfactory performances of an active power filter system. The use of the LCL-type filter has the advantage of eliminating the high frequency switching harmonics in the current injected into the power supply. This paper is mainly focused on analyzing the influence of the interface filter parameters on the active filtering performances. Some design aspects are pointed out. Thus, the design of the AC interface filter starts from transfer functions by imposing the filter performance which refers to the significant current attenuation of the switching harmonics without affecting the harmonics to be compensated. A Matlab/Simulink model of the entire active filtering system including a concrete nonlinear load has been developed to examine the system performances. It is shown that a gamma LC filter could accomplish the attenuation requirement of the current provided by converter. Moreover, the existence of an optimal value of the grid-side inductance which minimizes the total harmonic distortion factor of the power supply current is pointed out. Nevertheless, a small converter-side inductance and a damping resistance in series with the filter capacitance are absolutely needed in order to keep the ripple and oscillations of the current at the converter side within acceptable limits. The effect of change in the LCL-filter parameters is evaluated. It is concluded that good active filtering performances can be achieved with small values of the capacitance and converter-side inductance.

Keywords—Active power filter, LCL filter, Matlab/Simulink modeling, Passive filters, Transfer function.

I. INTRODUCTION

CERTAINLY, the superior performances of the shunt active power filters (SAPF) based on voltage source converters (VSCs) made them the most adopted solution in improving power quality of nonlinear loads at the point of common coupling to the power supply.

Mihaela Popescu is with Faculty of Electromechanical, Environmental and Industrial Informatics Engineering, University of Craiova, 200440 Craiova Romania (phone: +40 251 435 255; fax: +40 251 435 255; e-mail: mpopescu@em.ucv.ro).

A. Bitoleanu is with Faculty of Electromechanical, Environmental and Industrial Informatics Engineering, University of Craiova, 200440 Craiova Romania (phone: +40 251 435 255; fax: +40 251 435 255; e-mail: abitoleanu@em.ucv.ro).

M. Dobriceanu is with Faculty of Electromechanical, Environmental and Industrial Informatics Engineering, University of Craiova, 200440 Craiova Romania (phone: +40 251 435 255; fax: +40 251 435 255; e-mail: mdobriceanu@em.ucv.ro).

This work was supported by Romanian Ministry of Education and Research, Grant 21-010/2007.

The active filtering performance in terms of harmonic

distortion factor of the supply current is substantially influenced by the passive components associated with the VSC structure, i.e. the interface filter to interconnect the converter to the power supply and the DC capacitor.

The main goal of the interface filter is to reduce the switching harmonic distortion of the injected current as much as possible to prevent the switching harmonics from propagating into the power supply. On the other hand, the flow of harmonics to be compensated must be allowed.

Typically, the passive interface filter is either of first-order L type or of third-order LCL (inductor-capacitor-inductor) type.

In practice, the simple L filter is not able to ensure the active filter dynamics nor to provide sufficient attenuation of the current ripple due to the converter switching. An efficient alternative is to connect the active filter to the power supply through an LCL filter as shown in Fig. 1.

As both high and low frequency characteristics of the LCL-type filters are superior compared to those of L type, the third order filters have been increased in popularity in recent years.

The proper design of the LCL filter is a sensitive action especially when the VSC control is based on hysteresis controllers which lead to a variable switching frequency.

There are a lot of approaches to tuning a LCL filter, most of them related to interconnecting the VSC to the power network in an active rectification structure. In [1], the LCL filter design is achieved together with the control of the active rectifier using proportional-plus-integral based control strategies for the DC voltage and the AC current. In accordance with [2], the total inductance of the filter should be selected at first to meet the requirement of current ripple and the converter-side inductance should be much higher than the grid-side inductance. Some methods using the resonance frequency and the attenuation of the line current amplitude at the switching frequency as the main design parameters are presented in literature [3], [4], [5]. To avoid stability problems, passive additional damping resistors or active damping solutions have already been studied and tested [1], [4]. The current control of the voltage source inverter connected to the power supply through an LCL-filter based on state estimators has been presented in [6].

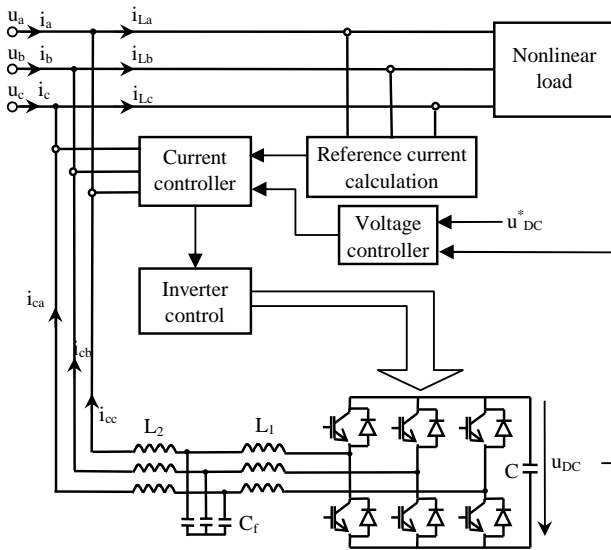

Fig. 1 Structure of a three phase shunt active power filter system with LCL interface filter

Design considerations on the LCL interface filter between the active power filter and the power supply have been very little treated in literature.

Different strategies to generate the reference currents for the current controllers have been analyzed in [7] and the advantages of the Fourier method have been pointed out for imposed values of the LCL filter.

Contribution [8] had the practical goal to replace the existing L type interface filter of a four-wire active power filter with an LCL filter in order to diminish the ripple of the current injected into power network. Small inductors in parallel with damping resistors were selected on the supply-side while the capacitors selection took into consideration the desired resonant frequency.

Reference [9] proves that the performances of a passively damped LCL filter can be close to those of an active damped LCL filter and that the additional losses are not significant.

Some transfer functions from the output voltage of a single-phase inverter to the currents and condenser voltage of the LCL filter have been expressed and interpreted in [10]. The total inductance of the passive filter has been chosen respecting the rated values of DC voltage and maximal current through inverter. Then, the effect of distribution of the total inductance over the grid-side and converter-side are analyzed, while the capacitance is adjusted to maintain an imposed value of the resonance frequency.

This paper investigates the influence of the LCL filter parameters on the active filtering performance based on Matlab/Simulink time-domain simulations.

II. INTERFACE FILTER TRANSFER FUNCTIONS

The equivalent single phase of the idealized LCL filter (Fig. 2), where the series resistances of the inductors are neglected,

allows expressing the following equations in the domain of Laplace transform.

$$I_1(s) = I_2(s) + I_c(s), \quad (1)$$

$$U_1(s) - U_c(s) = sL_1 I_1(s), \quad (2)$$

$$U_c(s) - U_2(s) = sL_2 I_2(s), \quad (3)$$

$$I_c(s) = sC_f U_c(s), \quad (4)$$

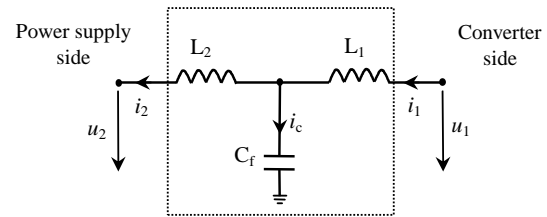

Fig. 2 Equivalent single phase diagram of the idealized LCL filter

As the design process of the passive filter depends on the attenuation needed to reduce the high switching frequency components of the currents provided by SVC, the transfer function between converter-side current and grid-side current is expressed on the basis of (1)-(4).

$$H(s) = \frac{I_2(s)}{I_1(s)} = \frac{1 - \frac{U_2(s)}{U_1(s)} (1 + s^2 L_1 C_f)}{1 + s^2 L_2 C_f - \frac{U_2(s)}{U_1(s)}}. \quad (5)$$

Assuming the harmonic frequencies domain, then $U_2(s)=0$ and the transfer function becomes:

$$H(s) = \frac{1}{L_2 C_f s^2 + 1}. \quad (6)$$

The previous expression shows that the attenuation of harmonic currents does not depend on the converter side inductance of the interface filter.

The Bode plot in Fig. 3 illustrates the maximum magnitude at natural frequency

$$f_n = \frac{1}{2\pi\sqrt{L_2 C}} \quad (7)$$

and an attenuation of -40dB/decade over the cutoff frequency,

$$f_{cutoff} = \sqrt{2} f_n. \quad (8)$$

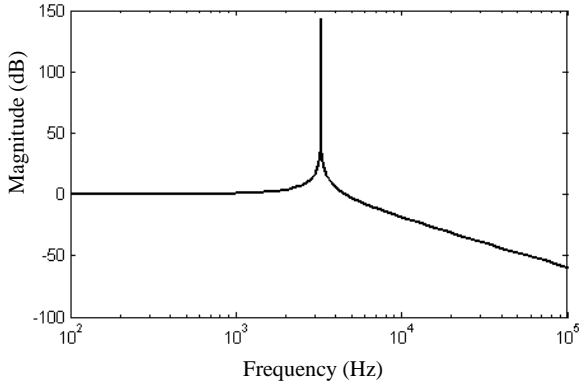

Fig. 3 Frequency response from converter-side current to grid-side current

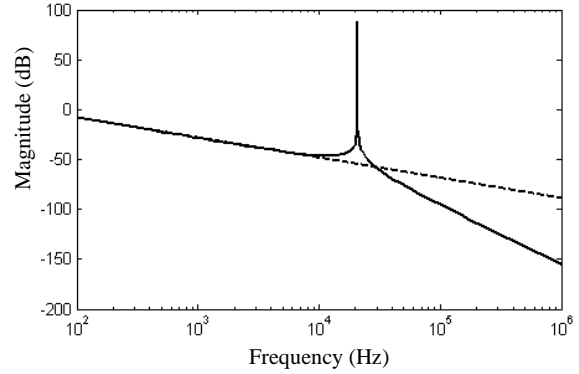

Fig. 4 Frequency responses from VSC output voltage to grid-side current for LCL-filter (solid line) and L-filter (dashed line)

Additional transfer functions of the LCL-type filter are addressed and interpreted in literature, such as $I_1(s)/U_1(s)$, $I_2(s)/U_1(s)$, $I_c(s)/U_1(s)$, $U_c(s)/U_1(s)$ [1], [8], [10].

Among these transfer functions, the admittance transfer ratio $Y_{21}(s) = I_2(s)/U_1(s)$ gives information on the advantages of the LCL filter compared to the ordinary first order L filter configuration and can be taken into consideration in LCL filter design. It is expressed as

$$Y_{21}(s) = \frac{I_2(s)}{U_1(s)} = sC_f \frac{1 - \frac{U_2(s)}{U_1(s)}(1 + s^2 L_1 C_f)}{(1 + s^2 L_1 C_f)(1 + s^2 L_2 C_f) - 1} \quad (9)$$

In the harmonic frequencies domain, where $U_2(s)=0$, the expression (9) becomes:

$$Y_{21}(s) = \frac{sC_f}{(1 + s^2 L_1 C_f)(1 + s^2 L_2 C_f) - 1} = \frac{1}{L_1 L_2 C_f s^3 + (L_1 + L_2)s} \quad (10)$$

The associated frequency response is shown in Fig. 4 compared to L filter frequency characteristic. It is shown that, if the total inductance is the same, both filters have the same behaviour at low frequencies, while the LCL-filter is better at high frequencies area since the harmonic admittance decreases by 60 dB/decade for the LCL-filter compared to 20 dB/decade for the L-filter.

III. INTERFACE FILTER PARAMETERS

In designing the inductors and capacitor values, the harmonic filtering requirements must particularly be taken into consideration, i.e. the interfacing filter has to reject the switching harmonics without affecting the harmonics to be compensated. For this reason, the cutoff frequency must be below the switching frequency in order to obtain a rejection current slope of -40dB/decade. Thus, the following condition is obtained:

$$f_s \geq \sqrt{2} f_n = \frac{1}{\pi \cdot \sqrt{2L_2 C}} \quad (11)$$

where f_s is the switching frequency.

Besides, the minimum frequency which determinates the filter pass band must exceed the highest harmonic frequency to be compensated. Hence, taking into account the superior pass band limit of $f_n/\sqrt{2}$ which has no influence on the input signal, the second condition is expressed:

$$f_N \leq \frac{1}{2\pi \cdot \sqrt{2L_2 C}} \quad (12)$$

where f_N is the lowest frequency among the harmonic frequencies to be rejected by the interface filter.

Conditions (11) and (12) can be written together as follows:

$$\frac{1}{2\pi^2 f_s^2} \leq L_2 C \leq \frac{1}{8\pi^2 f_N^2} \quad (13)$$

For instance, by imposing $f_s = 10$ kHz and $f_N = 2$ kHz, expression (13) becomes:

$$0.51 \cdot 10^{-9} \text{ (rad/s)}^{-2} \leq L_2 C \leq 3.17 \cdot 10^{-9} \text{ (rad/s)}^{-2} \quad (14)$$

Since the product $L_2 C$ domain is large and several combinations of L_2 and C values fulfil the previously

expressed conditions, a detailed analysis of the whole active filtering system is essential to find an optimal solution.

In addition, although a gamma filter composed of L_2 and C should be enough to accomplish the current supply ripple attenuation, the practical implementation of this solution makes evident unacceptable high current spike and excessive rate of current change at the VSC-side, as shown in section IV. Consequently, the converter-side inductance is indispensable and a damping solution is required.

IV. ANALYSIS OF ACTIVE FILTERING PERFORMANCES

Several computer simulations have been carried out under Matlab/Simulink environment in order to examine the influence of the interface filter parameters on the active filtering performances. Thus, the system in Fig. 1 has been implemented into the Simulink model shown in Fig. 5.

The nonlinear load taken into consideration is an uncontrolled rectifier supplying a PWM inverter. The distorted load current of $THD = 44\%$ and the supply voltage are shown in Fig. 6.

The control strategy to generate compensation commands is based on the Fourier analysis of the distorted load current to extract its fundamental component.

To generate gating signals for the switching devices of the active power filter the hysteresis-based current (1 A) control has been implemented.

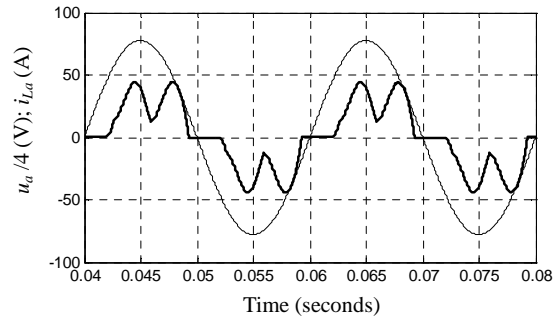

Fig. 6 Waveforms of supply voltage (thin line) and distorted load current (thick line) of $THD = 44\%$

In order to avoid the superposition effect of the DC-bus voltage control on the system performances, the assumption of an ideal DC voltage regulator has been made, so that the DC voltage can be considered constant. A value of 710V has been taken into consideration for this case study.

The shunt active power filter is charged to compensate both the load current harmonics and the reactive power.

The filtering performances have been appreciated in terms of tracking of the compensating currents compared to the desired values, the total harmonic distortion factor of the supply current, the ripple current at the converter-side as well as of the active filtering effectiveness factor defined as:

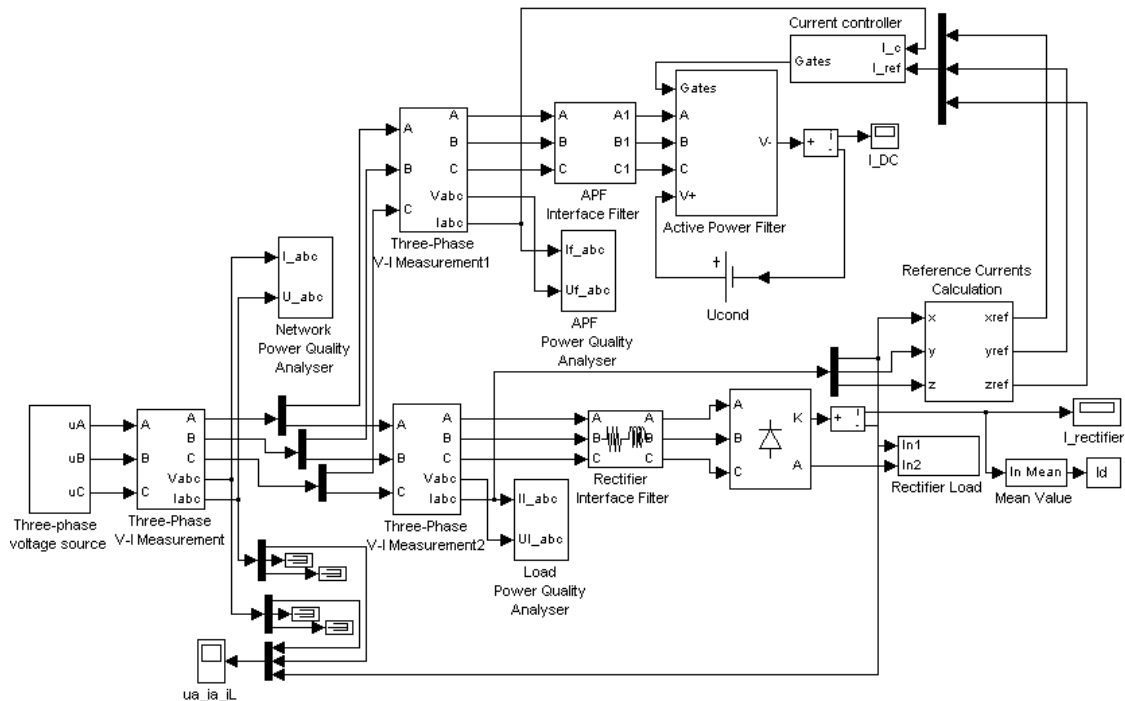

Fig. 5 Matlab/Simulink model of the active filtering system

$$AFE = \frac{THD_L}{THD_S} 100, \tag{15}$$

where THD_L and THD_S denote the total harmonic distortion factor of the supply current without and with the APF system.

Since the attenuation of the converter side current ripple through the interface filter is essential, the influence of parameters L_2 and C_f has been examined at the beginning. Thus, as illustrated in Fig. 7, keeping a constant value of filter capacitance, there is an optimal inductance which minimizes the power supply harmonic distortion. Moreover, for both $C_f=0.6\mu F$ and $C_f= 3\mu F$ taken into consideration, the optimal value of L_2 is of about 4mH and the corresponding minimum THD is of about 6.4%.

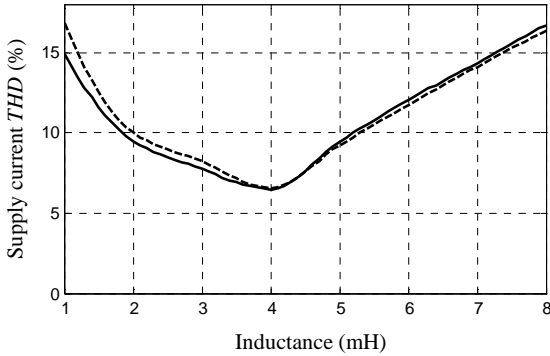

Fig. 7 Supply current THD versus inductance L_2 for $C_f=0.6\mu F$ (solid line) and $C_f= 3\mu F$ (dashed line)

The current injected into the power supply by the gamma L_2C filter tracks the reference current provided by the current control loop (Fig. 8). As a result, the compensation task is accomplished, i.e. the supply current is almost sinusoidal and its fundamental is in phase with the voltage supply (Fig. 9).

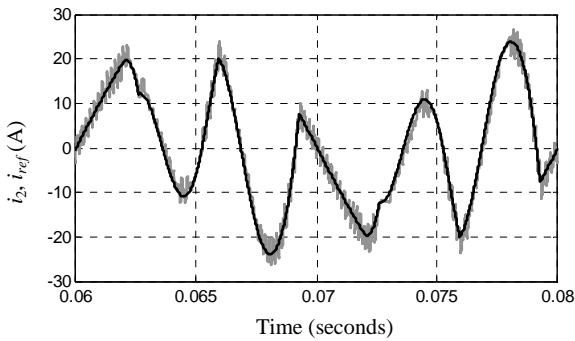

Fig. 8 Waveforms of current to be compensated (in black) and current i_2 (in gray) for $L_2= 4mH$ and $C_f=0.6\mu F$

Although the active filtering effectiveness factor introduced by (15) is high (of about 6.8), the lack of converter-side inductance leads to unacceptable spikes in both VSC input and output currents (Fig. 10).

As it can be seen in Fig. 11, the simple addition of the inductance L_1 is not satisfactory due to the significant oscillations of the current at the converter-side.

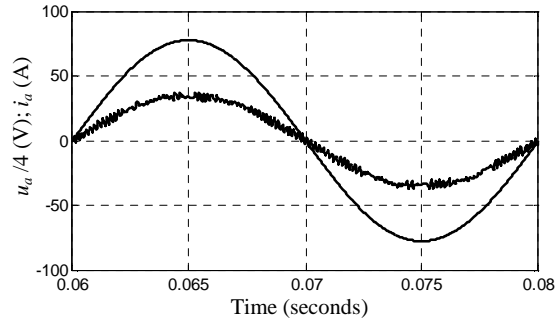

Fig. 9 Waveforms of supply voltage and current for $L_2= 4mH$ and $C_f=0.6\mu F$

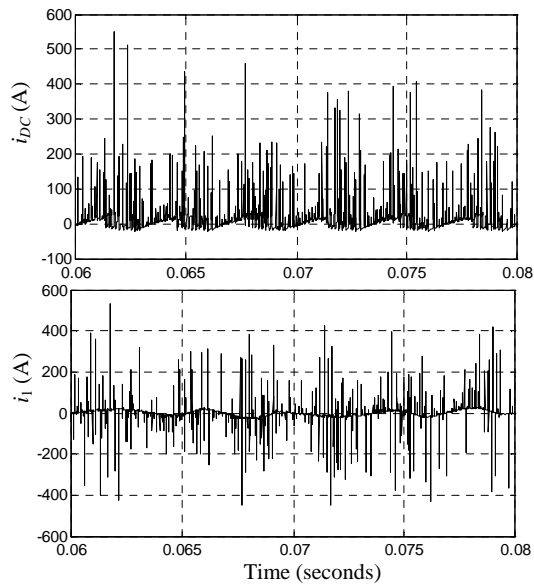

Fig. 10 DC-side current and VSC output current for $L_2= 4mH$ and $C_f=0.6\mu F$

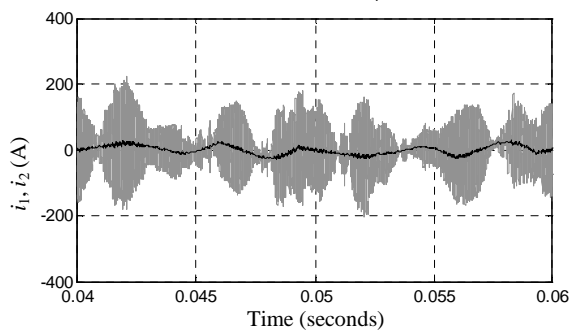

Fig. 11 Input (in gray) and output (in black) currents of the LCL filter for $L_2= 4mH$, $C_f=0.6\mu F$ and $L_1=0.1mH$

To reduce the current ripple and oscillations to acceptable values, damping resistances are placed in series with the filter capacitors (Fig. 12). Thus for instance, by inserting a damping resistance of 5Ω an important diminution of current oscillations is obtained as illustrated in Fig. 13. The price is however the increasing of system losses and a little decreasing of AFE factor value to about 6.

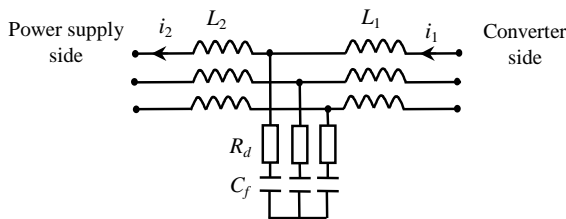
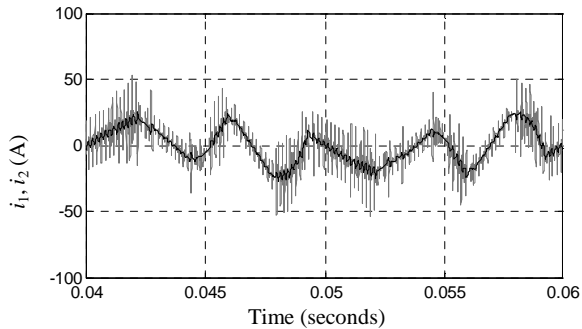
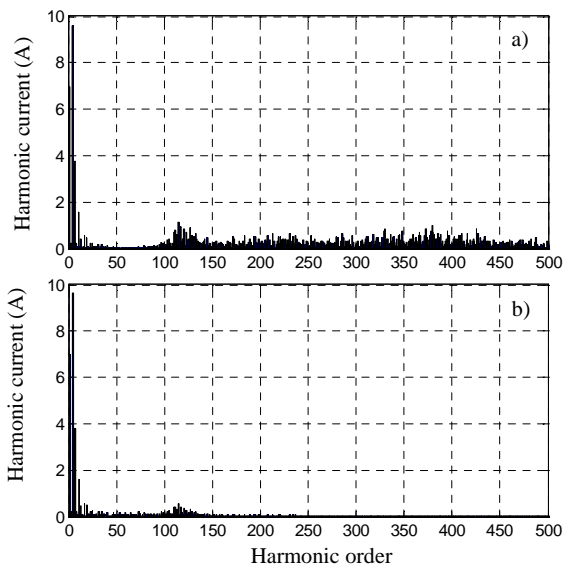

Fig. 12 LCL interface filter with damping resistors

Fig. 13 Input (in gray) and output (in black) currents of the LCL filter for $L_2=4\text{mH}$, $C_f=0.6\mu\text{F}$, $L_1=0.1\text{mH}$ and $R_d=5\Omega$

The harmonic spectra of the current through inductances L_1 and L_2 point out even better the efficiency of the interface filter (Fig. 14).

Fig. 14 Harmonic spectra of the current through inductance L_1 (a) and inductance L_2 (b)

Thus, in addition to the harmonics to be compensated, the current through the converter-side inductance contains superior harmonics over the 100th order. Their weight related to the fundamental component required to compensate the reactive power gets near to 15% (Fig. 14a). Concurrently, the same high order harmonics of the current through L_2 are strongly attenuated so that, practically, there is no harmonic over 150th order (Fig. 14b).

V. CONCLUSIONS

The use of the LCL-type filter to interface the three phase SAPFs based on VSCs to the power supply is an efficient solution due the ability of eliminating high order switching current harmonics. As the tuning process based on transfer functions is rather flexible, time-domain simulations have been carried out to find optimal parameters of the interface filter in order to improve the active filtering performances. Although the lack of converter-side inductance seems to have no influence on the current tracking performance, a small converter-side inductance and a damping resistance in series with the filter capacitance are absolutely needed in order to keep the ripple and oscillations of the current at the converter-side within acceptable limits.

The existence of an optimal power supply-side inductance which minimizes the total harmonic distortion factor of power supply current is pointed out.

It is concluded that good active filtering performances can be achieved with a smaller capacitance and smaller converter-side inductance compared to the corresponding values in literature [8], [9], [10].

REFERENCES

- [1] M. Liserre, F. Blaabjerg, and S. Hansen, "Design and control of an LCL-filter-based three-phase active rectifier," *IEEE Trans. Ind. Appl.*, vol. 41, no. 5, pp. 1281-1291, 2005.
- [2] Y. Lang, D. Xu, Hadianamrei S.R, and H. Ma, "A novel design method of lcl type utility interface for three-phase voltage source rectifier," in *Proc. of 36th IEEE Power Electronics Specialists Conference*, pp. 313-317, 2005.
- [3] P. Peltoniemi, R. Pollanen, M. Niemela, and J. Pyrhonen, "Comparison of the effect of output filters on the total harmonic distortion of line current in voltage source line converter - Simulation study," 2006, 5 s., *ICREPQ 2006*, Mallorca, Espanja, 2006.
- [4] M. Liserre, A. Dell'Aquila, and F. Blaabjerg, "Genetic algorithm-based design of the active damping for an LCL-filter three-phase active rectifier," *IEEE Trans. Power Electronics*, vol. 19, no. 1, pp. 76-86, 2004.
- [5] H.R. Karshenas and H. Saghafi, "Performance investigation of LCL filters in grid connected converters, in *Proc. IEEE PES Transmission and Distribution Conference and Exposition*, pp.1-6, 2006.
- [6] E.J. Bueno, F. Espinosa, F.J. Rodriguez, J. Ureila, and S. Cobrecas, "Current control of voltage source converters connected to the grid through an LCL-filter, in *Proc of 35th Annual IEEE Power Electronics Specialists Conference*, vol.1, pp. 68 - 73, 2004.
- [7] M. Lindgren and J. Svensson, "Control of a voltage source converter connected to the grid through an LCL-filter—application to active filtering," in *Proc. of the IEEE PESC'98*, vol. 1, pp. 229-235, 1998.
- [8] S. Pettersson, M. Salo, and H. Tuusa, "Applying an LCL-filter to a four-wire active power filter," in *Proc. Power Electr. Specialists Conf-Pesc'06*, pp.1413-1419, 2006.
- [9] M. Routimo and H. Tuusa, "LCL type supply filter for active power filter -Comparison of an active and a passive method for resonance damping," in *Proc. Power Electronics Specialists Conference*, pp. 2939-2945, 2007.
- [10] B. Bolsens, K. De Brabandere, J. Van den Keybus, J. Driesen, and R. Belmans, "Model-based generation of low distortion currents in grid-coupled PWM-inverters using an LCL output filter," *IEEE Trans Power Electronics*, vol. 21, No. 4, pp.1032-1040, July 2006.