

Numerical Analysis of End Plate Bolted Connection with Corrugated Beam

M. A. Sadeghian, J. Yang, Q. F. Liu

Abstract—Steel extended end plate bolted connections are recommended to be widely utilized in special moment-resisting frame subjected to monotonic loading. Improper design of steel beam to column connection can lead to the collapse and fatality of structures. Therefore comprehensive research studies of beam to column connection design should be carried out. Also the performance and effect of corrugated on the strength of beam column end plate connection up to failure under monotonic loading in horizontal direction is presented in this paper. The non-linear elastic-plastic behavior has been considered through a finite element analysis using the multi-purpose software package LUSAS. The effect of vertically and horizontally types of corrugated web was also investigated.

Keywords—Corrugated beam, monotonic loading, finite element analysis, end plate connection.

I. INTRODUCTION

THE performance of steel moment-resisting frames (MRF) is greatly affected by the characteristics of the beam-to-column connections, particularly in seismic areas. The traditional view is to use rigid and full strength beam-to-column connections in the steel MR frames in seismic zones. However, after the North-ridge earthquake-California-1994, bolted connections which are generally semi-rigid and partially resistant have been extensively investigated. A considerable number of literatures have been published on the seismic behavior of the extended end-plate connections which are the common type of bolted connections. Prior researches showed that steel connections are ductile and has high ability to dissipate energy safely when subjected to either seismic or cyclic loading. In addition, the corrugated webs are performed to allow the use of thin plates without stiffeners in buildings and bridges. It could eliminate the usage of larger thickness and stiffeners that contributed to the reduction of beam weight and cost. The first studies were carried out by Elgaaly [5] and have been further developed to the practical stage. Most of these analytical and experimental studies concentrated on the trapezoidal vertically corrugated webs.

Many researchers have conducted experimental and theoretical programs to observe the behavior of extended end-plate connections under monotonic, cyclic, and seismic loads. Butterworth [1] used a full scale testing in order to consider extended end-plate beam-to-column connections. It was found that the higher loading on the connection, the greater distribution of stress into the web beam will be. Theoretically,

[2] presented a model including unstiffened flush end plate connection. In this model, welds, bolt heads, and column fillets were not included, since their contributions to moment-rotation characteristics were insignificant. Machaly et al. [3] used the T stiffener (based on simple mathematical models and finite element results) in order to determine the effect of connection and geometric parameters on moment and stress distribution of a beam to column connection.

Sherbourne and Bahaari [4] developed a methodology to evaluate the moment rotation relationships for the steel bolted end-plate connections using finite element software ANSYS. Results revealed that at the ultimate load, the preloading on the bolts did not affect both, the prying action and the distribution of the forces in the beam flange. However, the bolt size showed a significant influence on the prying action.

Elgaaly et al. [6] investigated the failure mechanisms of corrugated beams under shear, bending and compressive patch loads. It was found that the failure of beams under shear loading is due to buckling on the web, where local and global for coarse and dense corrugation respectively. Zhang et al. [7], [8] and Li et al. [9] studied the influence of the corrugation parameters and developed a set of optimized parameters for the wholly corrugated web beams based on the basic optimization on the plane web beams. It was also found that the corrugated web beam has 1.5–2 times higher buckling resistance than the plane web beam.

The typical corrugated web plate girder consists of two steel flanges welded to a steel web that is corrugated. There are many types of corrugations possible such as trapezoidal, sinusoidal, triangular and rectangular, etc. throughout this investigation corrugated webs of arc corrugation were selected.

In this research, which is related to simulation study, the behavior of beam-to-column end plate bolted connections (Fig. 1) under monotonic loading in horizontal direction was investigated.

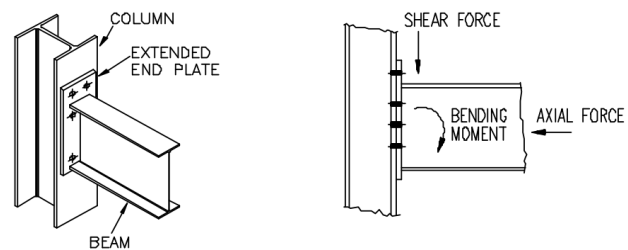

Fig. 1 Standardized beam-column extended end plate bolted connection

J. Yang, Q. F. Liu and M. A. Sadeghian are with the Department of Civil Engineering, Shanghai Jiao Tong University, Shanghai, 200240 China (Corresponding author: M. A. Sadeghian, e-mail: alisadeghian@sjtu.edu.cn, j.yang.1@sjtu.edu.cn, liuqf@sjtu.edu.cn).

II. NON-LINEAR FINITE ELEMENT ANALYSIS

A. Description of the Models

Four models of beam-to-column end plate connections were chose in this investigation, in which the first model is a control model (model 1) with standardized web beam-column connection under the monotonic loading in vertical direction

carried out by Butterworth [1] in half size. The other models of model 2, model 3 and model 4 were the corrugated beam-column connection. For the horizontally corrugated case, one arc and two arcs were studied, while half-circular wave corrugation was used for the vertical type. Figs. 2 and 3 show the details description of each model's corrugated beam.

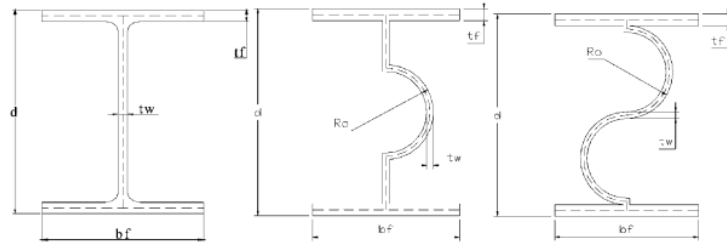

Fig. 2 Front view of corrugation plane web mode 1, 2, 3

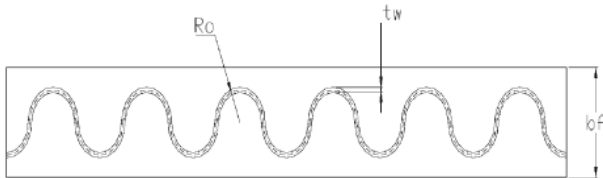

Fig. 3 Front view of vertical arc corrugation models

Basically, each model consisted with the same size of beam 356x171x51UB and 1000 mm in length with defined size of column, end plate, and number bolts and also in LUSAS welding between end plate and beam assume as rigid. For the horizontal and vertical case, corrugated webs with one arc and two arcs were considered while the depth of the webs was kept the same. Details of connections for all models are shown in Fig. 4. All models were simulated using finite element software LUSAS. Three dimensional of non-linear analysis were carried out for all models.

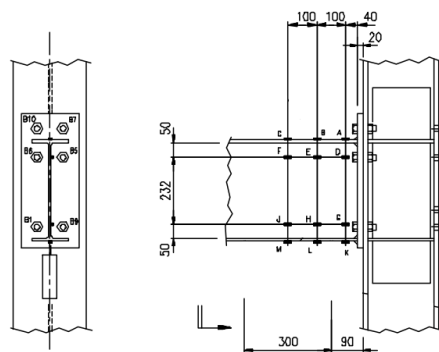

Fig. 4 Details of connections

B. Material Properties

Table I shows the details description of steel materials used for beam, column and end plate in each model, whilst the high strength steel material was used for the bolts with initial yield

stress of 600 N/mm². Fig. 5 shows the constitutive stress-strain curve for bolts, beam, column, and end plate.

TABLE I
STEEL MATERIAL

Material	Steel
Elastic Modulus	2.09*10 ⁵ N/mm ²
Young Poisson Ratio	0.3
Plastic Initial Uniaxial Yield Stress	406 N/mm ²
Hardening Gradient	2121 N/mm ²
Plastic Strain	1

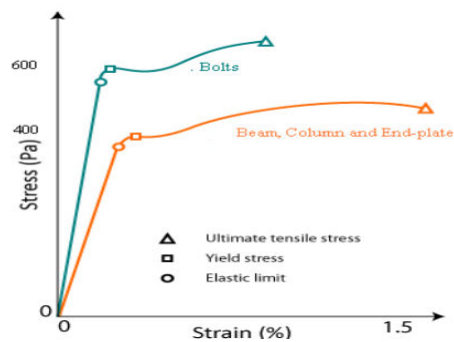

Fig. 5 Constitutive stress-strain curve for bolts, Beam, column, and end plate

C. Simulation Analysis

Simulations for all corrugated beam-column end plate connection models were carried out in monotonic loading analysis. Comparison of the simulation results with the laboratory test results for model 1 was also carried out to show negligible differences between them and to ensure the accuracy of simulation procedure and analytical method. The finite element analysis results were compared to examine the validity and predictability of the developed FE model. The 50x50 mm mesh size was chosen for all models. The defined mesh size was obtained based on the results of convergence studies on this

connection system. Typical mesh generated for elements for all models in LUSAS is shown in Figs. 6-9.

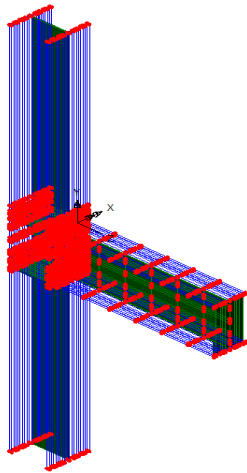

Fig. 6 Mesh arranging model 1

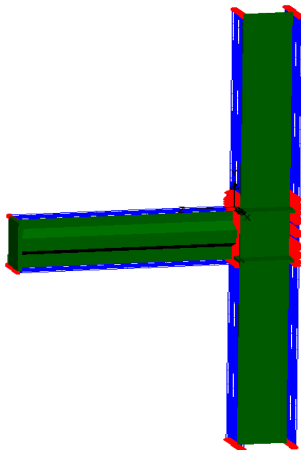

Fig. 7 Mesh arranging model 2

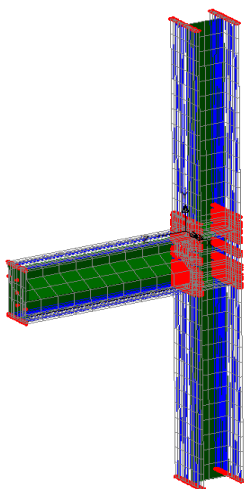

Fig. 8 Mesh arranging model 3

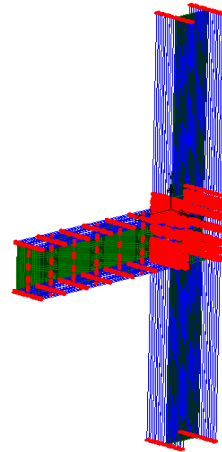

Fig. 9 Mesh arranging model 4

D. Element Types

Five types of element used for all models as shows in Fig. 10. In modeling apply HX8M, QTS4, BRS2, JNT4, TTS elements which has kind of nodes, degree of freedom to model the beam flange, end plate, connecting column flange, corrugated web, column web, nonlinear contact gap joint, interface between the end plate and column flange, bolt and etc in LUSAS.

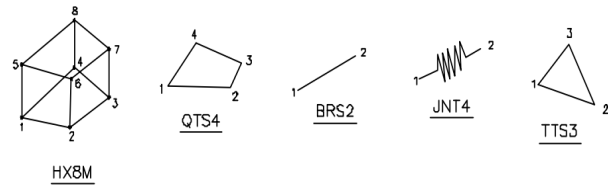

Fig. 10 FEA elements

III. RESULT AND DISCUSSION

A. Verification of Material Modeling

In corrugated beam, it is clear that beams with vertically corrugated web stands superior moments than the horizontal type. The vertically corrugated web provides a stronger support against the flange buckling, compared to the plane, and horizontally corrugated web types. In addition, corrugated web beams with larger corrugation radius could sustain upper bending moment. The comparison of the LUSAS simulation results for model 1 with the laboratory test under vertical monotonic loading carried out by [1] showed that the Force-displacement curves were comparable. It shows that the maximum load carrying capacity from FE modeling is 290 kN.mm and whilst from Experimental [1] is 300 kN.mm, as shown in Fig. 11. According to the results, due to horizontal monotonic loading as shown in Figs. 12-15 we can see the ultimate load of each model. In Fig. 16, the ultimate load of the corrugated models is equal to each other by negligible difference between them. The average amount of this ultimate load is near to 100 kN. According to the results as shows in Fig. 13, due to horizontal monotonic loading, there are the same load

capacity drop drastically mechanism for all corrugated models (100 kN).

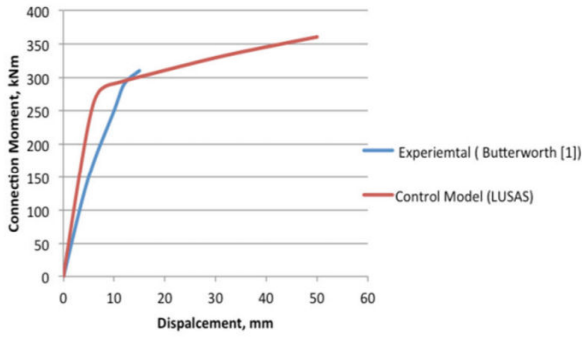

Fig. 11 Load-Displacement curve for standard beam experimental and model 1 under monotonic loading

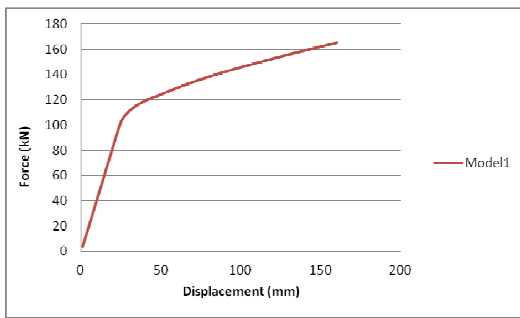

Fig. 12 Load-Displacement curve for standardized model 1 under horizontal monotonic Loading

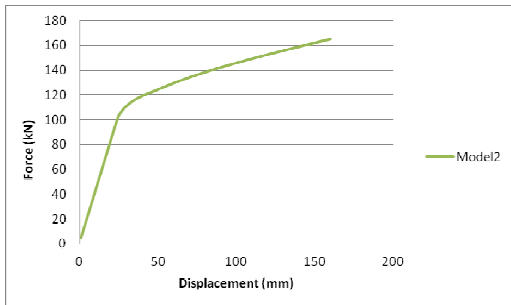

Fig. 13 Load-Displacement curve for horizontal one arc corrugated model 2 under horizontal monotonic loading

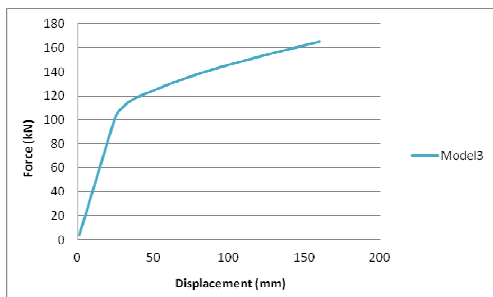

Fig. 14 Load-Displacement curve for horizontal two arc corrugated model 3 under horizontal monotonic loading

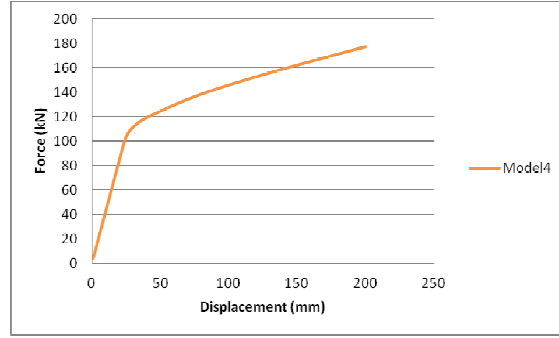

Fig. 15 Load-Displacement curve for vertical arc corrugated model 4 under horizontal monotonic loading

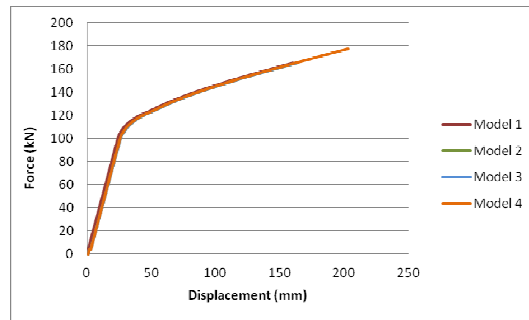

Fig. 16 Load-Displacement curve for all arc corrugated models under horizontal monotonic loading

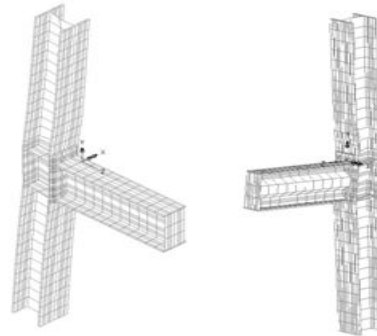

Fig. 17 Deflected Shape of Model 1, 2 due to Horizontal Monotonic Loading

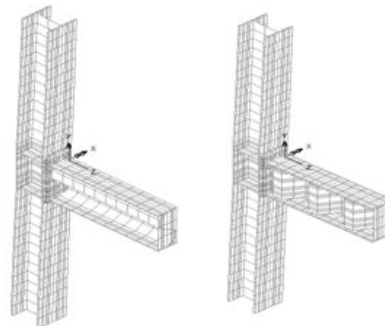

Fig. 18 Deflected shape of model 3, 4 due to horizontal monotonic loading

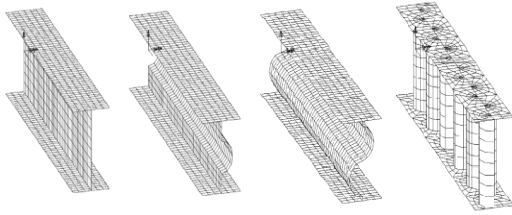

Fig. 19 Finite element model for the kind of standardized and corrugated beam investigated

Figs. 17 and 18 show the deflected shape of the models and also the typical finite element model of the corrugated web and plane web beam created for this project are shown in Fig. 19.

IV. CONCLUSION

In this paper, a three-dimensional finite element model using the computer package LUSAS is developed for structural behavior studies of steel connection systems under monotonic loading. Models of corrugated beam- to- column end plate connections were simulated to failure. Through series of simulation modeling, the following conclusions are drawn:

- 1) The joints should have adequate strength and stiffness to resist the internal forces induced by the framing members and external force like earthquake and wind loadings.
- 2) Based on LUSAS result, it shows that the performance of end plate bolted connection model simulated by LUSAS is comparable to experimental results and simulation analysis by other researchers.
- 3) The corrugated web beam model behaved similar plane web beam in end plate connection, therefore it should dissipated same energy like the other beam to column connection.

ACKNOWLEDGMENT

The authors are grateful for the financial support given by Shanghai Jiao Tong University.

REFERENCES

- [1] Butterworth, J. (1997). Finite element analysis of structural steelwork beam to column bolted connections. Constructional Research Unit, School of Science & Technology, University of Teesside.
- [2] Hasan, R.; Kishi, N.; Chen, W.F.; and Komuro, M. (1997). Evaluation of rigidity of extended end-plate connections. *Journal of Structural Engineering*, 123(12), 1595-1602.
- [3] Machaly, E.B.; Safar, S.S.; and Youssef, M.A. (2004). Parametric analysis of welded beam-to-column connections with T-stiffener. *Journal of Engineering and Applied Sciences*, 51(1), 47-66.
- [4] Sherbourne, A. N.; and Bahaari, M. R. (1991). 3D simulation of end-plate bolted connections. *Journal of Structural Engineering*, 120 (11), 3122-3136.
- [5] Elgaaly M, Seshadri A, Hamilton RW. Beams with corrugated webs, research to practice. In: Proceedings of the Jun 14-16 1995 NSF Research Transformed into Practice: implementation Conference. VA (USA): Arlington; 1995, p. 603-12.
- [6] Elgaaly M, Hamilton RW, Seshadri A. Shear strength of beams with corrugated webs. *Journal of Structural Engineering ASCE* 1996; 122(4):390-8.
- [7] Zhang W, Zhou Q, Li Y, Cai Z, Widera GEO. Hot rolling technique and profile design of toothshape rolls. Part 1: Development and research on H-beams with wholly corrugated webs. *Journal of Materials Processing Technology* 2000; 101(1):110-4.
- [8] Zhang W, Li Y, Zhou Q, Qi X, Widera GEO. Optimization of the structure of an H-beam with either a flat or a corrugated web. Part 3: Development and research on H-beams with wholly corrugated webs. *Journal of Materials Processing Technology* 2000; 101(1):119-23
- [9] Li Y, Zhang W, Zhou Q, Qi X, Widera GEO. Buckling strength analysis of the web of a WCW H-beam: Part 2. Development and research on H-beams with wholly corrugated webs (WCW). *Journal of Materials Processing Technology* 2000; 101(1):115-8.