

Natural Flickering of Methane Diffusion Flames

K. R. V. Manikantachari, Vasudevan Raghavan and K. Srinivasan

Abstract—Present study focuses on studying the oscillatory behavior of jet diffusion flames. At a particular jet exit velocity, the flames are seen to exhibit natural flickering. Initially the flickering process is not continuous. In this transition region as well as in the continuous flickering regime, the flickering displays multiple frequency oscillations. The response of the flame to the exit velocity profile of the burner is also studied using three types of burners. The entire range of natural flickering is investigated by capturing high speed digital images and processing them using a MATLAB code.

Keywords—Diffusion flames, Natural flickering, flickering frequency, intermittent flickering

I. INTRODUCTION

FLICKERING of flame is an interesting phenomenon in basic laminar diffusion flame study. It is associated with the interaction of vortices in the flow with the flame. An elementary flame/vortex interaction is typically periodic, regular and reproducible in nature [1], [2]. Elaborate study has been done on this subject to estimate the flickering frequency, and its response considering different fuels, fuel flow rates, burner sizes, effect of gravity, pressure and co-flow air [3]-[6]. The frequency of flickering is always of the order of around 10 Hz and is not affected by either the dimensions of the burner or other parameters [7]. The formation of stratified layer between the hot gases of combustion and the cold quiescent ambient air initiates the flickering phenomenon, which further leads to the Kelvin-Helmholtz instability [8]. As the fuel flow rate increases, the steady flame established on a burner starts to show the flickering behavior. Initially the flickering is not continuous and shows an intermittent behavior. Most of the flickering flame studies are dedicated to the phenomenon of continuous flickering. Maxworthy [9] studied the transition of steady flame to continuous flickering flame, which oscillates with a robust frequency, however, the studies on flame behavior on transition from steady to continuous flickering are scanty. Present study focuses on the behavior of the flame over the entire range (steady, intermittent and continuous flickering). Especially the multiple frequencies in the transition and continuous regimes are investigated. The response of the flame to the exit velocity profile of the burner is also studied using three types of burners.

K.R.V. Manikantachari is a graduate student in the Indian Institute of Technology Madras, Chennai, Tamilnadu 600036 INDIA (phone: +91-9176551201; fax: +91-44-22574650; e-mail: raghuvmkc@gmail.com).

Vasudevan Raghavan is an Assistant Professor in the Indian Institute of Technology Madras, Chennai, Tamilnadu 600036 INDIA (phone: +91-44-22574712; fax: +91-44-22574650; e-mail: raghavan@iitm.ac.in).

K. Srinivasan is a Professor in the Indian Institute of Technology Madras, Chennai, Tamilnadu 600036 INDIA (phone: +91-44-22574703; fax: +91-44-22574650; e-mail: ksri@iitm.ac.in).

II. EXPERIMENTAL SET UP

A. Burner construction

The schematic burner configuration is shown in Fig.1. Experiment is conducted using 3 burners made out of brass, having three different exit geometries, which are contoured, straight pipe and orifice exits. These three burners generate different velocity profiles at the exit, namely, tap-hat velocity profile, parabolic velocity profile and saddle key velocity profile [10]. These burners are fastened to a settling chamber. The burner length and lip thickness are maintained the same for the three burners. Fuel is allowed to flow in to the settling chamber. Two metal meshes inside the settling chamber helps in making the fuel flow uniform.

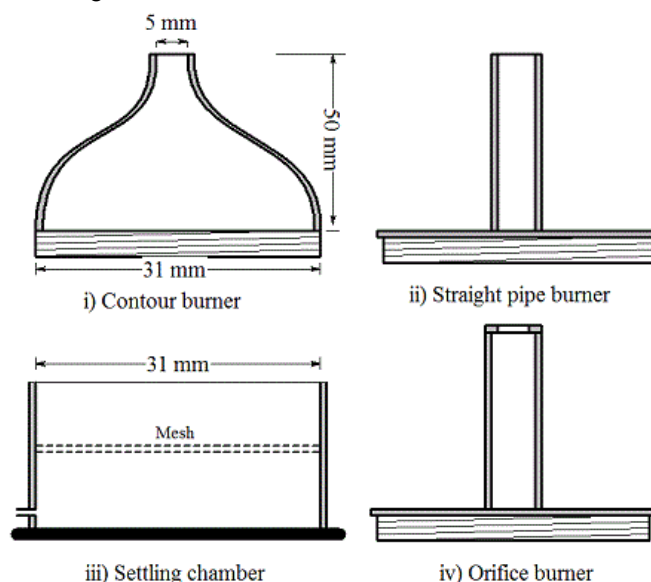

Fig. 1 Schematic diagram of the three burner exit geometries used in the present study (i) Contour burner, (ii) Straight pipe burner, (iii) Settling chamber and (iv) Orifice burner

B. Flow metering and control

The fuel used in this study is methane of purity 99.95%. This is supplied from a gas cylinder through a pressure regulator. Methane at a regulated pressure is sent through a manual control valve, which is used for safety measures. Its flow rate is controlled by a digital mass flow controller. The digital mass flow controller is sourced by a DC power supply. This stainless steel mass flow controller (Make: Aalborg; Model GFC17-07), is pre-calibrated for methane gas and is used to control the flow rate of gas to the burner quite precisely. The stainless steel body is preferred because the methane gas may be corrosive. The range of the mass flow controller is 0-1000 milliliter per minute (mlpm) with 1.0

mlpm resolution. The accuracy of the mass flow rate measured is within $\pm 1.5\%$ and repeatability is $\pm 0.5\%$. The initial warm-up time of the mass flow controllers (with flow) is around 15 minutes after switching the DC power supply on. The manual control valve is first opened, such that the maximum flow rate supplied to the mass flow controller is more than the required flow rate at its set point. Another pressure gauge is installed in the flow line upstream of the mass flow controller to monitor the line pressure.

C. Arrangement to capture digital photographs

High speed videos of diffusion flames are captured using a high speed digital camera (Casio EX-F1). The ISO sensitivity and focus are set appropriately with respect to the lighting and the zoom level. The frame rate is kept as 300 fps to cover at least 30 data points (11 Hz) per cycle which eliminates the aliasing error. The images are acquired for 180 seconds (54000 frames) to understand the steady flame behavior and intermittent flickering behavior of flame over a long time. And for continuous flickering range images acquired for about 15 seconds.

D. Experimental conditions and post processing

Experiments are carried out in a completely enclosed chamber to avoid disturbances due to air movement. Care has been taken to avoid any noise disturbance during the experiment as well. Fuel is supplied at a constant pressure of 0.5 bar (gauge) to the connected burner. A digital video at a frame rate of 300 fps is captured. Frames are extracted from of video by using open software called ImageJ. The extracted frames are processed in MATLAB® to estimate the flame heights as a function of time.

III. RESULTS AND DISCUSSION

Present study explains the behavior of the natural flickering of diffusion flames in burners with exit configurations such as straight pipe, contoured and orifice having same exit cross-sectional area, lip thickness and length. Flame behavior is recorded by using a high speed digital camera at the rate of 300 frames per second for varying fuel flow rates. These videos are processed in MATLAB® for analyzing the flame height variations and to carry out Fast Fourier Transform (FFT). As per the observations, the behavior of a laminar diffusion flame can be divided in to three regimes. They are,

- 1) Steady (non-fluctuating) flame,
- 2) Existence of intermittent flickering and
- 3) Flames exhibiting continuous flickering.

In the first regime, the flame height has negligible visual oscillations, even though when the video of such a flame is processed in MATLAB, very small oscillations are observed. This category of diffusion flames are as shown in Fig. 2.

In the second regime, flame fluctuates in some time intervals (Fig. 3a and 3c) and stops fluctuating in some other time interval (Fig. 3b); thus showing an intermittent behavior. The fuel flow rate at which intermittent flickering starts is reported in Table 1. The fluctuating behavior does not follow

any particular trend or constant time periods. For instance, in Fig. 3a, last two photographs show the formation of vortex and its shedding. However, in Fig. 3c, the time instant, where vortex formation and its shedding occurs, is different than in Fig.3a. The flow rate, at which intermittent flickering regime starts, is the highest for the orifice case, as shown in Table 1, while for the other two cases it is almost the same. Two white lines drawn on figures can be used for references to understand the height variation.

TABLE I
THE FUEL FLOW RATE AT WHICH INTERMITTENT FLICKERING STARTS IS REPORTED IN

Burner exit geometry	Fuel flow rate at which intermittent flickering starts (mlpm)	Fuel flow rate at which continuous flickering starts (mlpm)
i. Straight pipe	225	265
ii. Contoured	230	320
iii. Orifice	290	490

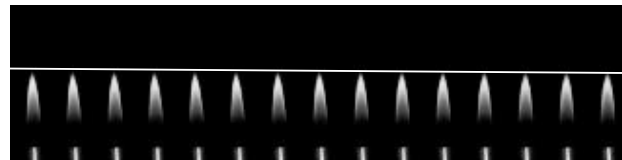
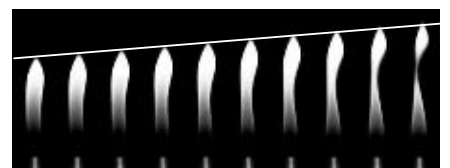
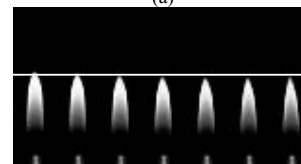

Fig. 2 Diffusion flame in straight pipe burner at 200 mlpm methane flow rate, which appears to be steady. Time interval between two consecutive images is 0.003 seconds.



(a)



(b)

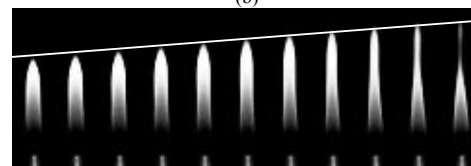

(c)

Fig. 3 Diffusion flame in a contoured burner at 310 mlpm methane flow rate, which exhibits intermittent flickering. (a) and (c) shows intermittently flame flickering with different amplitudes and (b) shows steady flames. Time interval between two consecutive images is 0.003 seconds

In the third regime, flame oscillates continuously as shown in Fig.4, where one complete cycle is shown. These, three regimes of a diffusion flame are based on the fuel flow rate values (Table 1). The flow rate at which continuous flickering regime starts is highest for the orifice case, as seen in the

intermittent flow rate. However, unlike the intermittent case, between the straight and contour burners, the flow rate at which the continuous flickering starts is much different.

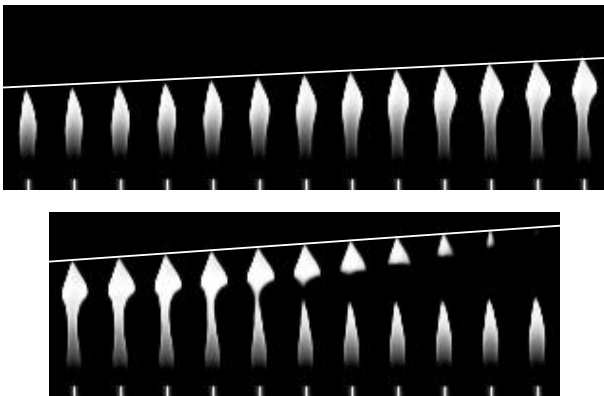

Fig. 4 Diffusion flame in an Orifice burner at 490 mlpm methane fuel flow rate, which oscillates continuously. Time interval between two consecutive images is 0.003 seconds

The range of flow rates in between the onset of intermittent fluctuations and the onset of continuous flickering can be defined as the transition flow range. One more useful parameter, called intermittency, can be defined as the percentage of the total time when the flame is fluctuating for a particular flow rate in transition range of the burner [9]. The overall results show that Orifice burner geometry favors the steady behavior of the flame till a higher flow rate.

1) Steady laminar diffusion flame:

Generally, a steady flame can be observed at very lower fuel flow rates. Flame height seems to be constant only visually. Figure 5 shows the flame height variation with respect to time for a straight pipe burner at fuel flow rate of 200 mlpm. It shows the existence of small variations in the flame height with respect to time and cannot be perceived by naked eye as observed in Fig. 2. In this case, the average flame height is 51.34 mm, maximum height is 51.93 mm and minimum height is 49.89 mm. Therefore the maximum wavelength of oscillation is only 1.45 mm, which is 2.82% of the average flame height. Figure 6 shows the Fast Fourier Transform (FFT) of above flame height sequence. Figure 6 is the FFT of whole flame height sequence shown in Fig. 5.

Figure 7 is the zoomed part of inset shown in Fig. 6. From Fig. 7, it is clear that the frequency of the fluctuation in Fig. 5 is 0.17 Hz, and is negligible. The reason for the invisibility of the visual fluctuations in this range is due to the very small amplitude and frequency of the fluctuations.

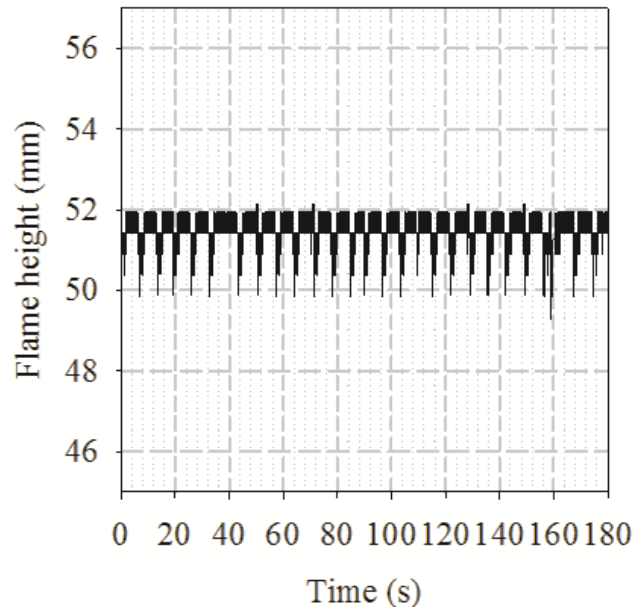

Fig. 5 Variation of flame height with respect to time for a straight pipe burner at a fuel flow rate of 200 mlpm

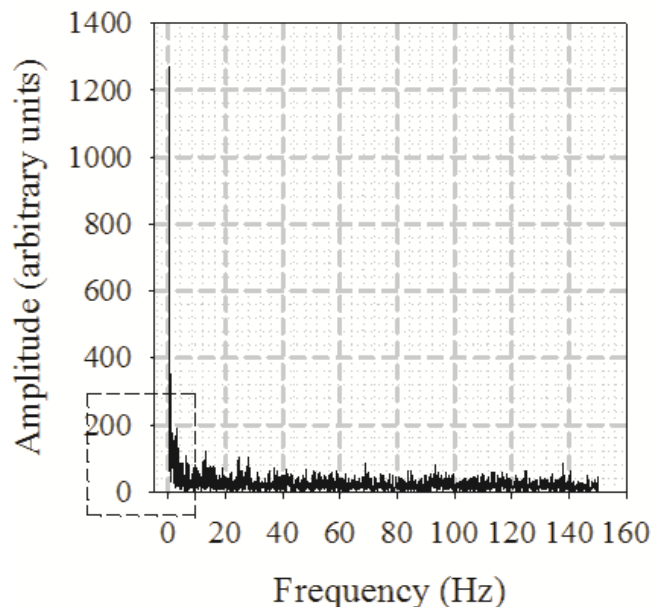

Fig. 6 Fast Fourier Transform of the flame height vs. time sequence for straight pipe burner at fuel flow rate of 200 mlpm

An earlier study [7] reported about the formation of a layer of combustion products around the flame, which triggers the onset of the continuous fluctuations. This layer is formed above a particular value of the fuel flow rate. This layer separates the un-burnt fuel with atmospheric air. Therefore, the reaction zone grows to acquire sufficient oxidizer, which in turn initiates the Kelvin - Helmholtz instability. Existence of fluctuations even in steady flame shows the existence of

product layer in this regime as well. The thickness of the layer could be very small such that by the time the flame about to grow the atmospheric air diffuses/entrains into the flame zone.

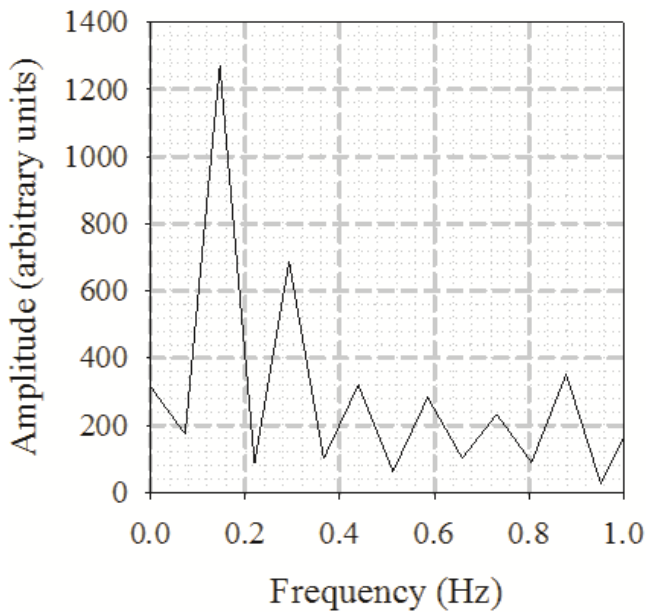

Fig. 7 Expanded view of the inset in Fig. 6, which shows the dominating frequency of oscillation at a flow rate of 200 mlpm.

2) Intermittent flickering diffusion flame:

As mentioned earlier, this phenomenon occurs in the transition phase between steady and continuous flickering regimes. The flame fluctuates in an intermittent fashion with non-uniform amplitudes. Figure 8 shows the flame height variation with respect to the time for a contoured burner at 310 mlpm. Non-uniform amplitudes can be seen in the insets of Fig. 8.

It is observed that in intermittent flickering regime, for the complete sequence of flame height over a long period, the dominating frequency of the fluctuations is close to zero. If only the fluctuating time period is analyzed by FFT, it is observed that the dominating frequency is 11 Hz, as shown in Fig. 9, where FFT is carried out for the time period indicated by the first inset in Fig. 8. In this intermittent regime, another important observation is the occurrence of multiple frequency fluctuations, when a particular time period of oscillations are analyzed using FFT. For example, when the second inset in Fig. 8 is analyzed using FFT, multiple frequencies are observed with 11 Hz as dominating frequency, as shown in Fig. 10. Figure 11 shows the FFT done on the whole flame height vs. time data in Fig. 8. This shows that the overall dominating frequency is zero, with a second dominant frequency at 11 Hz.

In the case considered in Fig. 8, the mean height of the flame fluctuation is around 77 mm and amplitude of oscillations varies from around 5 mm to 55 mm.

3) Continuous flickering laminar diffusion flame:

This phenomenon of flickering is visually observable. Processes such as flame growth and flame tip cut off due to vortex shedding occur in a cyclic manner. Flame grows linearly till it reaches maximum height as shown in Fig. 4. Vortex interaction with the flame increases the burning rate at a local point [6]. This forms a neck, a very thin area, on the flame as observed in Fig. 4. At particular instant the upper part of flame gets separated from the actual flame (Fig. 4), which is called flame tip cut off. The flame height just before tip cutting is considered as maximum height of the flame (Fig. 12).

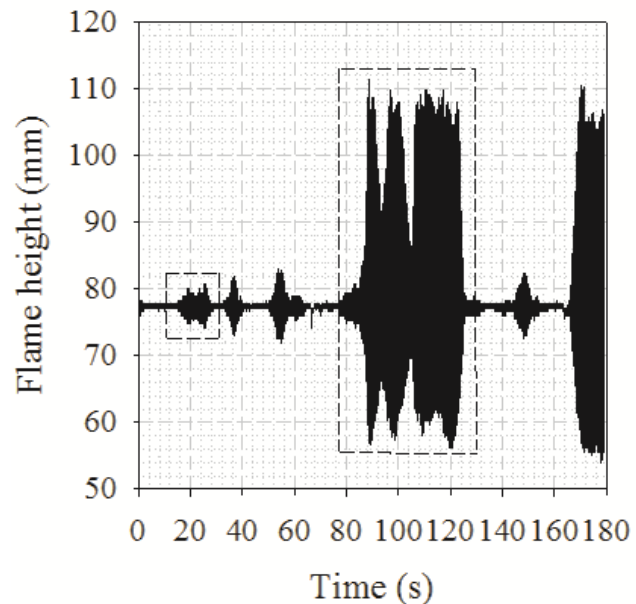

Fig. 8 Intermittent flame height variation with respect to the time, for a contoured burner at a fuel flow rate of 310 mlpm.

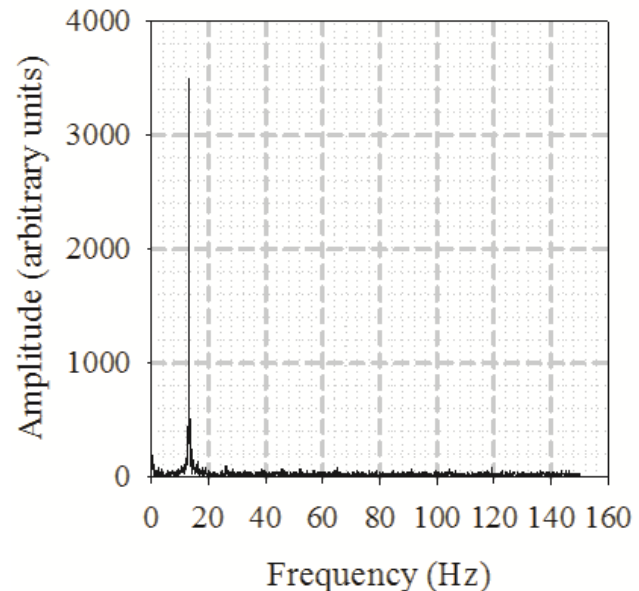

Fig. 9 FFT of flame height with time sequence in the first inset in Fig. 8

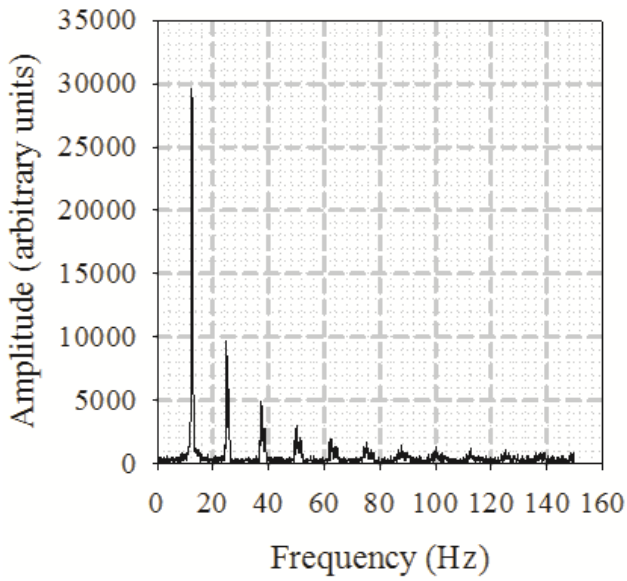

Fig. 10 FFT of flame height with time sequence in the second inset in Fig. 8

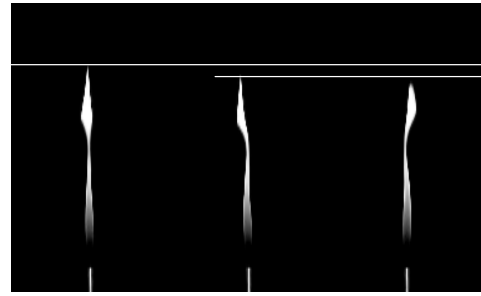

Fig. 12 Maximum heights of the continuous flickering diffusion flame for orifice burner at fuel flow rate of 490 mlpm. Images correspond to the time instants of 0.44, 0.51 and 0.59 seconds

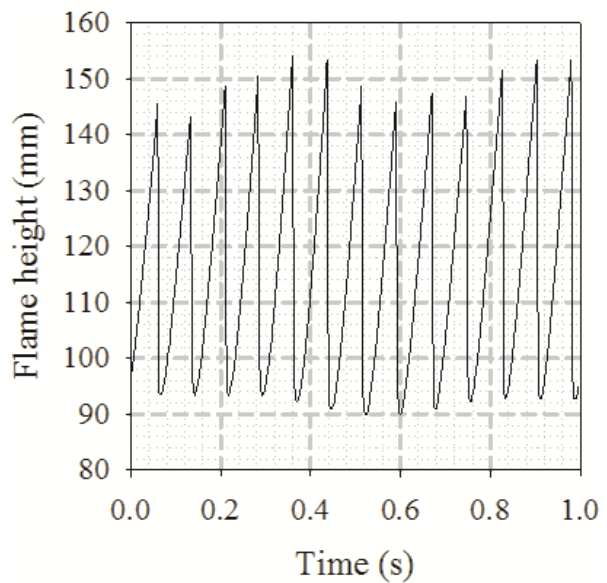

Fig. 13 Variation of flame height with respect to time for an orifice burner at a fuel flow rate of 490 mlpm

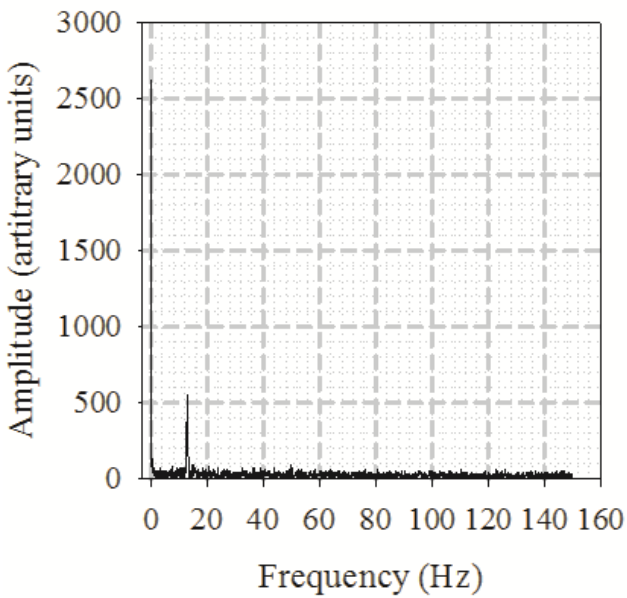

Fig. 11 Fast Fourier transform of flame height Vs time sequence of a contoured burner at 310 mlpm

Figure 13 shows the variation of flame height with respect to time for a straight pipe burner. It is observed from Fig. 13 that the flame height variations do not follow any harmonic trend. This is due to the formation of unsymmetrical vortices around the flame. Due to the interaction of these vortices, flame gets stretched.

Figure 14 shows the FFT plot for the data in Fig. 13. It is clear that the dominating frequency is 11 Hz. However, multiple peaks indicate that the flame height fluctuations are not following any particular harmonic oscillations.

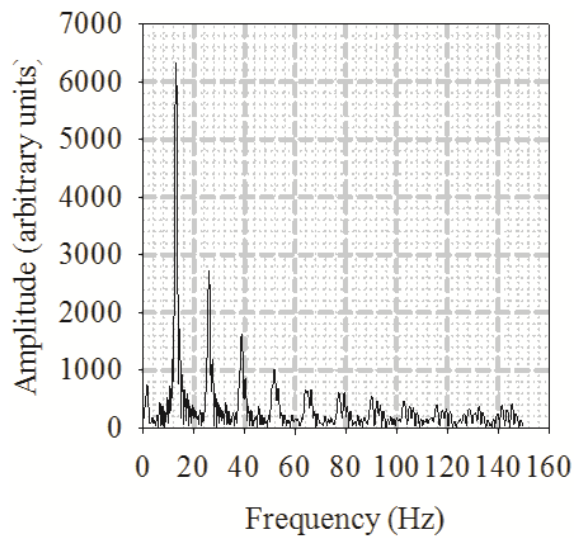

Fig. 14 Fast Fourier transform of flame height vs. time data in Fig. 13

V. CONCLUSION

Experiments are conducted in an enclosed room to investigate the characteristics of the natural flickering flame in three different burners. Flame behavior is captured in a high speed digital video camera and processed in MATLAB for determining transient flame height variations. Fast Fourier Transform of flame height variation data is also carried out.

The behavior of a laminar diffusion flame can be divided in to three regimes. In the first regime, the flame height has negligible visual oscillations. In the second regime, flame fluctuates in some time intervals and stops fluctuating in some other time interval, thus showing an intermittent behavior. In the third regime, flame oscillates continuously.

With processed high speed video data, it is observed that the flame fluctuates with small amplitudes even at the steady regime. When a flame fluctuates, it is observed that the dominating frequency is 11 Hz, with multiple frequencies with smaller amplitudes. Results clearly demonstrate that the orifice burner suppresses the flame fluctuations till a larger flow rate as compared to a contoured burner or a straight pipe burner.

REFERENCES

- [1] Albers BW, Agrawal AK. Schlieren analysis of an oscillating gas-jet diffusion flame. *Combust Flame* 1999; 119:84–94.
- [2] Lingens A, Neemann K, Meyer J, Schreiber M. Instability of diffusion flames. *Proc Combust Inst* 1996; 26:1053–61.
- [3] D. S. Chamberlin and A. Rose, First Symposium on Combustion, Ind. Eng. Chem. 20, 1013-1016 (1928).
- [4] Kimura, Tenth Symposium (International) on Combustion, the Combustion Institute, Pittsburgh, Pa., 1965, pp. 1295-1300.
- [5] Jizhao LI, Yang ZHANG, Fuel variability effect on flickering frequency of diffusion Flames. *Front. Energy Power Eng. China* 2009, 3(2): 134–140.
- [6] Hamidreza Gohari Darabkhani & Yang Zhang, Methane Diffusion Flame Dynamics at Elevated Pressures. *Combust. Sci. and Tech.*, 182: 231–251, 2010.
- [7] A. J. GRANT and J. M. JONES, Low-Frequency Diffusion Flame Oscillations, *Combustion and Flame*, 25, 153-160 (1975).
- [8] Buckmaster I; Peters N (1986) The infinite candle and its stability-a paradigm for flickering diffusion flame. *Twenty-First Symp. (Intern.) on Combustion/The Combustion Institute*, 1829-1836.
- [9] T. MAXWORTHY, The flickering candle: transition to a global oscillation in a thermal plume. *J. Fluid Mech.* (1999), vol. 390, pp. 297{323}.
- [10] W.R. Quinn, Upstream nozzle shaping effects on near field flow in round turbulent free jets, *European Journal of Mechanics B/Fluids* 25 (2006) 279–(301).