

Multiple Input Multiple Output Detection Using Roulette Wheel Based Ant Colony Optimization Technique

B. Rebekka, B. Malarkodi

Abstract—This paper describes an approach to detect the transmitted signals for 2×2 Multiple Input Multiple Output (MIMO) setup using roulette wheel based ant colony optimization technique. The results obtained are compared with classical zero forcing and least mean square techniques. The detection rates achieved using this technique are consistently larger than the one achieved using classical methods for 50 number of attempts with two different antennas transmitting the input stream from a user. This paves the path to use alternative techniques to improve the throughput achieved in advanced networks like Long Term Evolution (LTE) networks.

Keywords—MIMO, ant colony optimization, roulette wheel, soft computing, LTE.

I. INTRODUCTION

MIMO technique has been successfully implemented in advanced wireless networks including LTE networks in order to promise improved spectral efficiency. Modern communication systems demand higher data rates to facilitate support for quality rich applications like voice/video streaming, online gaming, e-commerce etc., for pedestrian as well as mobile users. LTE is a 4G technology that supports Orthogonal Frequency Division Multiple Access (OFDMA) in the downlink which is proven to be robust against multipath fading and interference. Also, Radio Resource Management (RRM) block which includes a mix of advanced Medium Access Control (MAC) and physical layer functions such as Adaptive Modulation Coding (AMC), Channel Quality Indication (CQI) reporting, Hybrid Automatic Retransmission request (HARQ) have been exploited which would further enhance the capacity of the network as stated by [1].

In addition to the conventional schemes like higher modulation schemes, improvising the bandwidths; MIMO systems have also been effectively utilized to meet the higher data rates demanded by most of the applications. Even though MIMO adds to the complexity in terms of processing and number of antennas, it has been considered as one other key element in LTE technology as it further enhances the data rate supported and the spectral efficiency.

This work addresses an Ant Colony Optimization (ACO) based detection scheme for 4G networks. ACO is one of the optimization techniques that is inspired by the ant's strategy in choosing the shortest path from a source to a destination as suggested in [2]. The idea of self organization and distributed

B. Rebekka and B. Malarkodi are with the Department of Electronics and Communication Engineering, National Institute of Technology, Tiruchirappalli, India (e-mail: rebekka@nitt.edu, malark@nitt.edu).

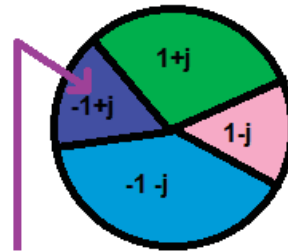

Fig. 1 Roulette wheel used in the proposed ACO algorithm for QPSK setup

control for efficiently solving real world problems in ants leads researchers to develop artificial ant colony based algorithms to solve mathematical optimization problems.

The motivation behind our work in using ACO technique is its successful application in solving optimization problems that arise in the field of telecommunication networks such as solving resource allocation problems as mentioned in [3], multiuser detection for CDMA systems as mentioned in [4], reduced complexity MIMO detection as pointed out in [5]-[8], in finding optimal routing decisions as mentioned in [9]. Even though Genetic Algorithm (GA) approach can be relied on to solve the resource allocation problem, our work is based on ACO, due to the fact that ACO based multiuser detection systems converge faster with significant complexity savings in comparison to its GA based counterpart as mentioned in [10].

Rest of the paper is organized as follows. Section II discusses about MIMO system, Section III discusses about conventional estimation schemes used in communication systems, Section IV details the proposed ACO based detection algorithm using MIMO, Section V brings out the results and discussions and finally Section VI concludes the paper.

II. MIMO SYSTEM

MIMO systems exploit spatial multiplexing to enhance capacity, coverage and also reliability of wireless systems. In such multi antenna transmission systems, information carried as data symbols can be considered as linear and time-invariant. Hence, the received signal is a linear combination of the transmitted data symbols, corrupted by additive Gaussian noise. We assume that entries in the transmitted vector are the points in 16QAM and QPSK constellation.

Each of the possible symbols is a combination of a real and a complex value and can be plotted as a point in the complex

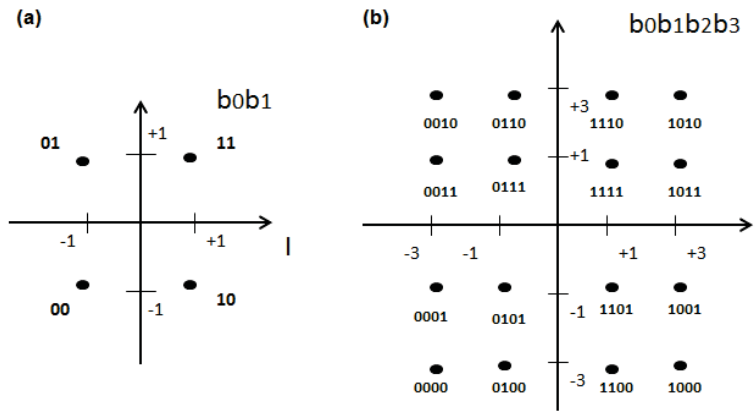

Fig. 2 Constellation diagram for (a) QPSK and (b) 16QAM

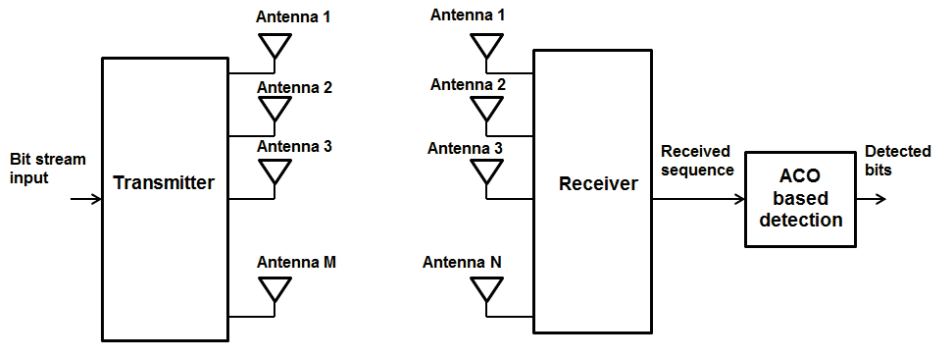

Fig. 3 Typical MxN MIMO model with ACO based detection

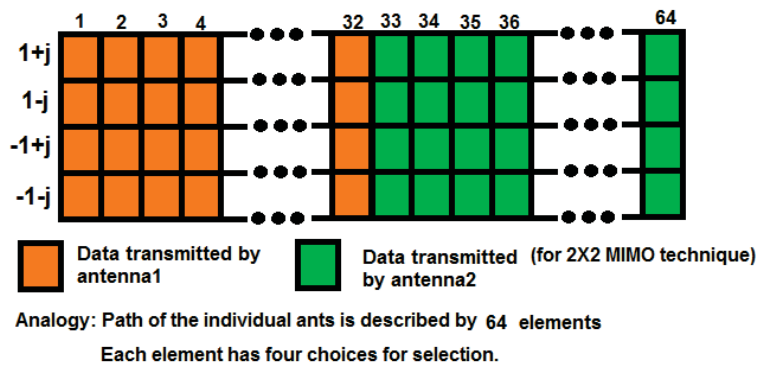

Fig. 4 Illustration of Pheromone matrix used in proposed scheme



a_i can be one among $1+j, 1-j, -1+j, -1-j$

Fig. 5 Illustration of Ant's path used in proposed scheme

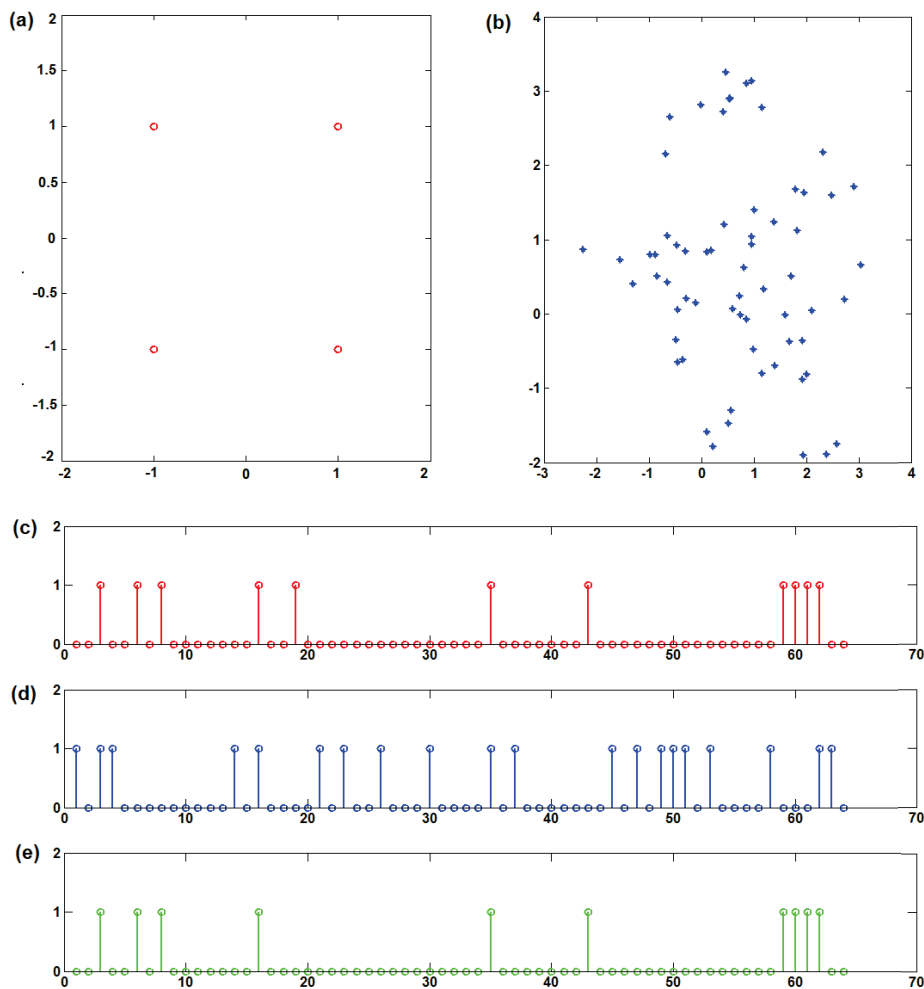

Fig. 6 (a) Constellation plot at transmitter (b) Constellation plot at receiver (c) Correctly detected sequence (zero valued samples) obtained using zero forcing detection (d) Using Least mean square based detection (e) Using the proposed ANT colony based detection for QPSK 2×2 MIMO

plane. Each point represents one of the M possible symbols. The constellation for QPSK and 16QAM modulation schemes is shown in Fig. 2. QAM modulation with M symbols is known as M -QAM (eg. 16QAM, 64QAM, 256QAM). Though non-square constellations are preferred for low values of M , square constellations are more common (even powers of two) so that constellation is made similar on both axes to enable simple implementations.

Let the transmitted signal vector be represented as, x and the corresponding detected signal vector y be represented as,

$$y = Gx + n \quad (1)$$

where G is the channel matrix (2×2) and n is the noise vector. The solution is optimal only when the noise is Gaussian. The noise vector follows gaussian distribution only if the vector size is large. At the receiver, the detector gets the estimate of the transmitted vector, \hat{x} . The optimal detector minimizes the probability of error, i.e. it minimizes $P(\hat{x} \neq x)$ as mentioned by [8].

Digital modulation schemes involve transmitting sequence of symbols of equal duration where each symbol is chosen independently from a set of M . This allows up to $b = \log_2(M)$ bits per symbol to be transmitted. In Quadrature Phase Shift Keying (QPSK), the phase of the signal is modified depending on the message symbols. Modulation is symbol based where one symbol contains 2 bits for QPSK. The real and imaginary parts of the complex baseband signal are modulated in amplitude for Quadrature Amplitude Modulation (QAM) scheme.

III. CONVENTIONAL ESTIMATION SCHEMES

In many cases, it is not just enough to make a decision between two (or more) distinct situations but rather there is a need to get the continuum of possible states of nature and we need to find as accurately as possible the actual value of the parameter from the observation as mentioned by [11]. These are in general referred to as estimation problems. In the proposed work, the transmitted symbols are estimated

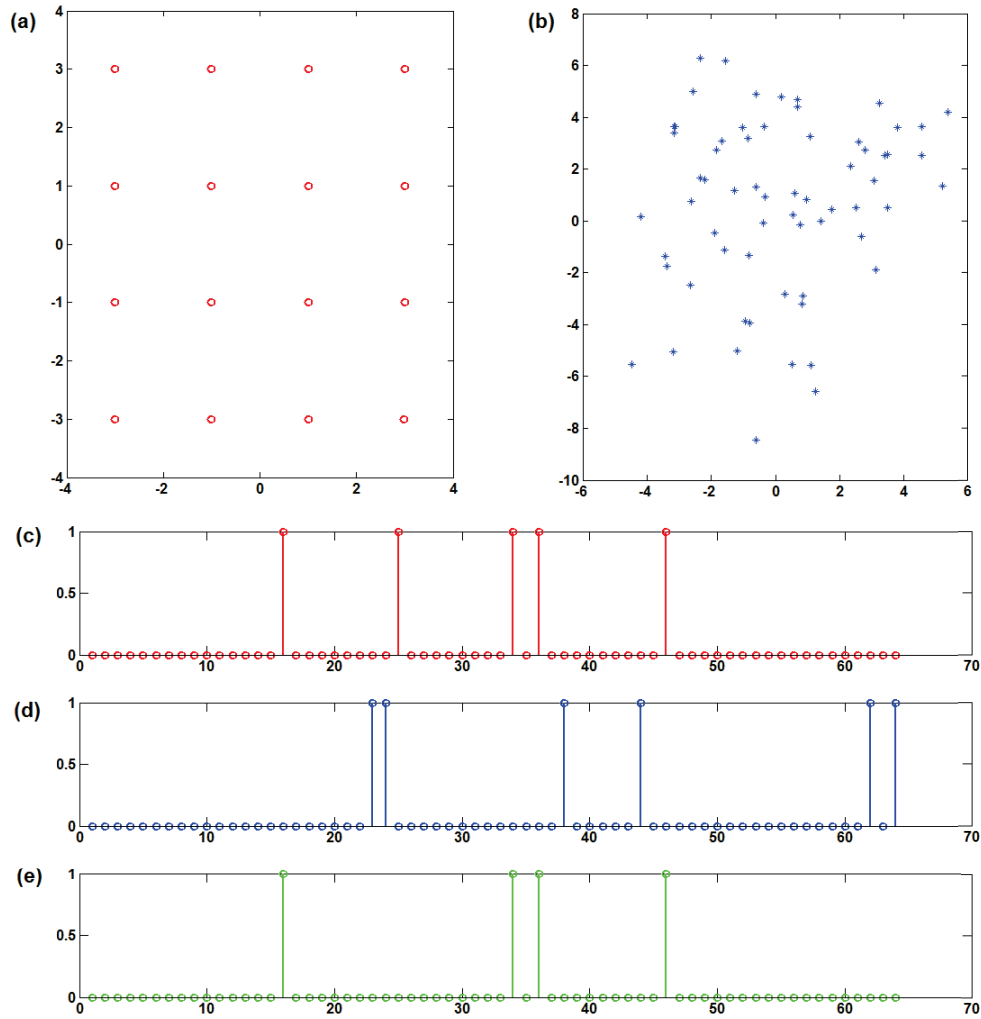

Fig. 7 (a) Constellation plot at transmitter (b) Constellation plot at receiver (c) Correctly detected sequence (zero valued samples) obtained using zero forcing detection (d) Using Least mean square based detection (e) Using the proposed ANT colony based detection for 16QAM 2×2 MIMO

using the conventional estimation algorithms such as Zero forcing (ZF) and Least mean square (LMS) algorithms and compared with proposed Ant Colony based algorithm for possible improvement in the performance.

A. Zero Forcing Algorithm

Zero forcing algorithm otherwise known as interference nulling algorithm has found its application in communication systems to nullify the interference signal in time domain or inverts the frequency response of the channel in frequency domain. This algorithm applies channel's frequency response to the received vector, so that the original transmitter vector can be detected. This algorithm is computationally less complex but performs well, when the prevailing signal quality measured by Signal to Noise ratio (SNR) is considerably high. By using Zero forcing algorithm, the transmitted signal vector can be estimated by minimizing, $\|y - Gx\|^2$.

The estimate of x is given by,

$$\hat{x} = (G^T G)^{-1} G^T y \quad (2)$$

where \hat{x} is the estimate of the transmitted vector and the corresponding detected signal vector is y , which can be represented as, $y = Gx + n$, where G is the channel matrix (2×2).

B. Least Mean Square Algorithm

In Least mean square estimation, $E(\|\hat{x} - x\|^2)$ is minimized with,

$$\hat{x} = C^H y \quad (3)$$

where $C = E(yy^H)^{-1} E(yx^H)$, $E(\cdot)$ is the expectation operator.

For the MIMO model $y = Gx + n$, the vector x is estimated as, $p_d(p_d G^H G + p_n I)^{-1} G^H y$, where p_d is the average power

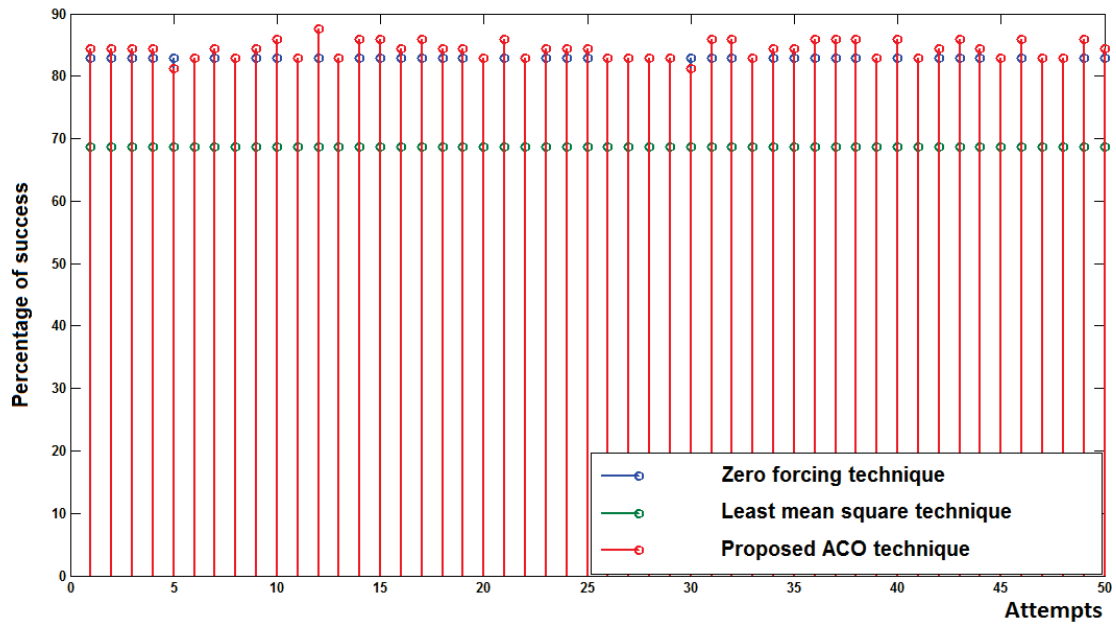

Fig. 8 Comparison of the percentage of success obtained for QPSK transmitted symbols with 2×2 MIMO setup

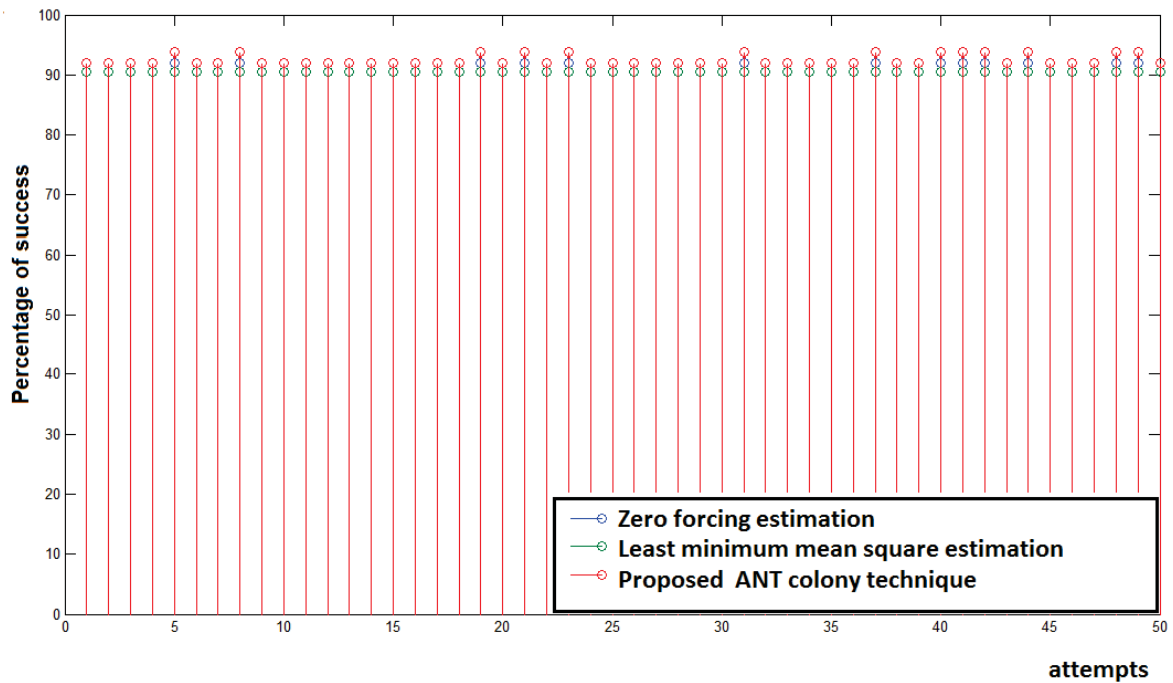

Fig. 9 Percentage of success obtained for 16QAM scheme with 2×2 MIMO

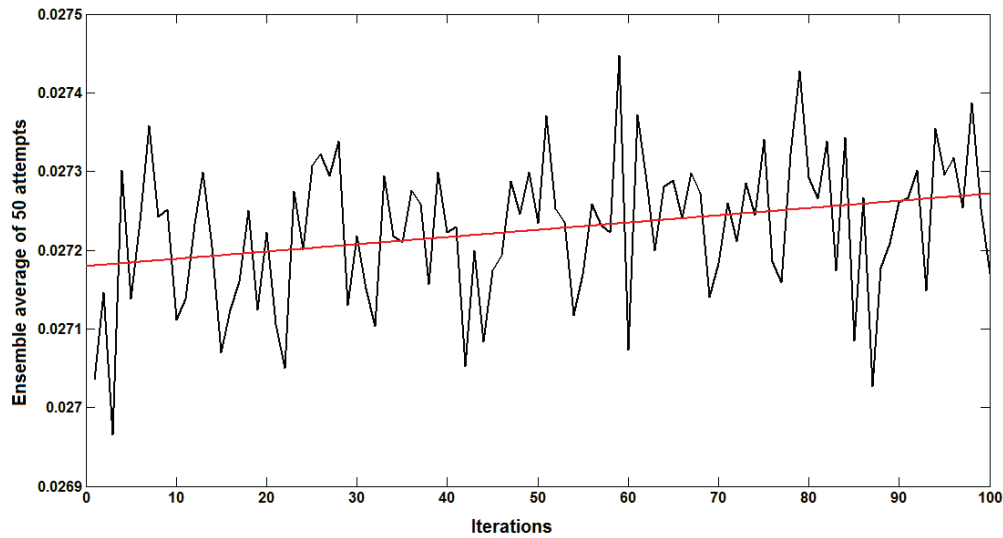

Fig. 10 Ensemble average of the convergence graph obtained using 100 iterations

of the signal, p_n is the average power of the noise, I is the identity matrix and G is the channel matrix. The solution is optimal if the additive noise is Gaussian.

IV. THE PROPOSED ACO-BASED DETECTION ALGORITHM WITH MIMO

Fig. 3 shows MXN MIMO system with proposed ACO based detection mechanism. In this paper, we propose to estimate \hat{x} using ACO. ACO algorithm is based on the foraging behavior of ants. Each ant leaves a chemical known as pheromone on their way from its source to a remote source of food. More the ants taking the same route, higher will be the pheromone concentration. As a beneficial effect of the pheromone, the ants about to set out from source later are more likely to choose the particular route marked by a higher concentration of pheromone. As a result, most ants will choose the shortest route from the nest to the source of food as said in [2].

As shown in Fig. 3, Bit streams from a source is fed to the MIMO transmitter with M transmitting antennas which transmit the incoming bits in parallel on all M different transmitting antennas. In the proposed work, two antennas at transmitting side and two at receiving side have been considered. The received sequence obtained at the receiver side is subjected to detection using the proposed ACO algorithm.

The typical estimate \hat{x} is considered as the path chosen by a particular ant to reach the destination from the source. We would like the ants to choose the best path (path consisting of highly concentrated pheromones). The pheromone concentration of a particular path chosen by an ant is considered as the value of fitness function associated with that particular estimate. The path of a typical ant consists of elements of a particular \hat{x} . Each element of that vector is chosen among the four values specified by $1 + j, 1 - j, -1 + j, -1 - j$. This is more specifically for QPSK modulation

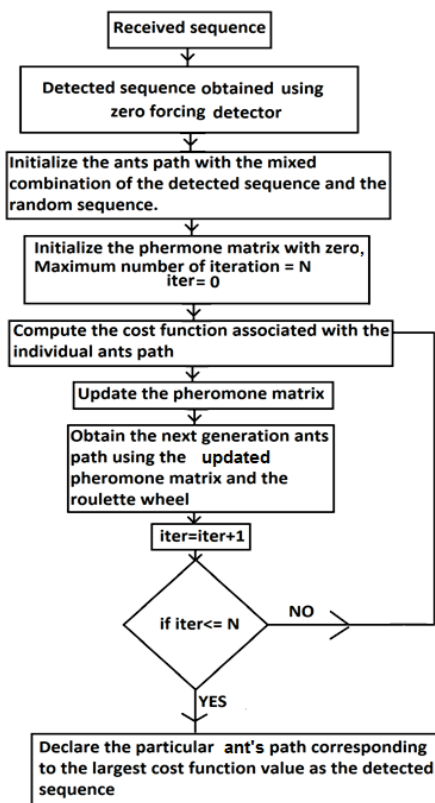

Fig. 11 Flow chart for the proposed ACO based detection technique

(simulation also has been carried out for 16QAM with 16 values as shown in Fig. 2 (b)).

The pheromone matrix considered is of size $4 \times 2S$ where S is the number of vectors transmitted. Note that each vector consists of 2 elements. The pheromone matrix sizes will be $16 \times 2S$, considering 16QAM with 2×2 MIMO.

The objective function is chosen as,

$$\hat{x} = \underset{x}{\operatorname{argmax}} \frac{1}{E(|y - Gx - n_1|)} \quad (4)$$

where n_1 is the artificially generated noise vector (uniform distribution).

A. Initialization of Ants Paths and Updating the Pheromone Matrix

Fig. 4 shows the pheromone matrix considered for 2×2 MIMO QPSK modulation case. Considering 32 symbols are been transmitted by each transmitter we have arrived with 64 elements with 2×2 MIMO scheme. The structure of typical ant's path is shown in Fig. 5. The elements in the ant's path can be one among the four values, $(1+j, 1-j, -1+j, -1-j)$. The number of ants paths are chosen as 500 and are initialized as follows. 50 ants paths are identically chosen and are obtained as the detected sequence obtained using zero forcing technique and the remaining 450 ants paths are randomly chosen and are altered to be one among the four values $(1+j, 1-j, -1+j, -1-j)$ and it will be alteration with one among 16 values for 16QAM case. The cost functions associated with the individual paths are computed and are used to update the pheromone matrix. For instance, let the cost function associated with i^{th} ant path is represented as C_i . If the k^{th} element of the ant path is $1+j$, then $(1, k)$ of the pheromone matrix is updated as $PM(1, k) = PM(1, k) + C_i$. Similarly if the k^{th} element of the ant path is $1-j$, then $(2, k)$ of the pheromone matrix is updated as $PM(2, k) = PM(2, k) + C_i$. Likewise, the pheromone matrix is updated for all the elements of all the paths. This completes a single iteration.

The paths selected for the next iteration is obtained using the roulette wheel mechanism as mentioned in [12]. Roulette wheel is a simplest selection mechanism which can be imagined as a wheel with segments on it and the wheel could be rotated on its axis. The fitness value decides the size of each of the segment. Larger the fitness value, larger will be the area of the segment. The wheel is allowed to rotate and settle down. A pointer considered pointing to a segment after the settlement of the wheel, will be considered as the chosen segment. Larger the area of the segment, higher will be its probability of selection. Roulette wheel selection mechanism and its blended form applied for Genetic algorithm can be found in [13]. Illustration of Roulette wheel for the QPSK case is shown in Fig. 1.

In the proposed work, Roulette wheel is simulated with four sectors considered as $1+j, 1-j, -1+j, -1-j$ (number of sectors will be 16 in the case of 16QAM scheme), with area of the individual sectors being proportional to the cost function in the k^{th} column of the pheromone matrix. This helps to fix the k^{th} element of the first path in the next iteration. This is

repeated to obtain 500 ants paths for the next iteration. Best solution (ant's path) in all the iterations is collected and the best among the collected paths is declared as the solution. Flow chart explaining the flow of the proposed ACO based detection scheme is shown in Fig. 11.

V. EXPERIMENTS AND RESULTS

The proposed ACO based detection algorithm has been compared with the conventional schemes like Zero forcing and Least mean square estimation methods. Analysis has been done in terms of finding the Percentage of success, Convergence and Difference between actual and detected symbols for both QPSK and 16QAM modulation techniques using 2×2 MIMO set up.

The results showing correctly detected sequence obtained for one particular attempt for 4 points and 16 points 2×2 MIMO for Zero forcing, Least mean square and proposed ACO detection schemes is shown in the Figs. 6 and 7 respectively. Proposed mechanism has been analyzed considering 64 transmitted elements. The number of iterations for every attempt is fixed as 100. The correctly identified complex samples are represented as zeros in the graph. More number of zeros obtained in Figs. 6 and 7 in the subplot corresponding to ANT colony based detection technique shows the effectiveness of the proposed technique.

Fig. 8 shows the percentage of success obtained using Zero forcing, LMS and proposed ACO based detection mechanism for QPSK transmitted symbols considering 2×2 MIMO setup. Analysis has been carried out for 50 attempts. It can be seen that improvement of about 17 percentage consistently over Least mean square and about 2 percentage for most of the attempts and about 4 percentage for few attempts over Zero forcing method has been achieved using proposed ACO mechanism.

Percentage of success (POS) which specifies the detection rate can be found using,

$$POS = \frac{\text{Number of successfully detected symbols}}{\text{Number of transmitted symbols}} \quad (5)$$

Fig. 9 compares the POS obtained for 50 attempts for Zero forcing, Least mean square and proposed technique for 16 points QAM scheme with 2×2 MIMO setup. Proposed technique is found to be outperforming the classical methods in all the attempts.

The ensemble average of the convergence graph for 50 attempts plotted for 16 points is given in Fig. 10. The graph illustrates the maximization of the fitness function. The red line in the convergence graph illustrates that maximization of the objective function is achieved over the iterations. Hence it is understood that proposed ACO based detection mechanism is capable of achieving enhanced performance over the existing conventional methods with significant savings in computational complexity.

VI. CONCLUSION

ACO based detection mechanism using MIMO technique has been presented and the same has been analyzed and

compared with the classical Zero forcing and Least mean square (LMS) techniques. Proposed ACO based detection scheme has been attempted for QPSK and 16QAM schemes which have been considered as the most promising modulation techniques used in most of the 4G networks like LTE. The results obtained are found to be satisfactory and obtained detection rates, convergence promises the usage of ACO based methods for detection in MIMO based 4G LTE communication systems.

B. Malarkodi is currently working as Associate Professor in the Department of Electronics and Communication Engineering at National Institute of Technology, Tiruchirappalli, Tamilnadu, India. She received the Ph.D. Degree from National Institute of Technology, Tiruchirappalli, Tamilnadu, India in the year 2010. She obtained the M.E. degree in Applied Electronics from Anna University, College of Engineering, Guindy, Chennai, Tamilnadu, India in the year 1990 and the B.E. degree in Electronics and Communication engineering from Bharathiar University, GCT, Coimbatore, Tamilnadu, India in the year 1986. Her research interests include Ad Hoc networks.

REFERENCES

- [1] Capozzi, F, Piro, G, Grieco, L. A, Boggia, G, and Camarda, P., "Downlink packet scheduling in LTE cellular networks: Key design issues and a survey", *IEEE Communications Surveys and Tutorials*, Vol. 15, No. 2, pp. 678-700, 2013.
- [2] Dorigo, M, Birattari, M, Stützle, T., "Ant colony optimization. Artificial ants as a computational intelligence technique", *IEEE Computational Intelligence Magazine*, pp. 28-39, 2006.
- [3] Zhao, Y, Xu, X, Hao, Z, Tao, X, and Zhang, P., "Resource allocation in multiuser OFDM system based on ant colony optimization", *IEEE Wireless Communications and Networking Conference (WCNC)*, pp. 1-6, 2010.
- [4] Xu, C, Yang, L. -L., and Hanzo, L., "Ant-colony-based multiuser detection for MC DS-SS-CDMA systems", *IEEE 66th Vehicular Technology Conference*, pp. 960-964, 2007.
- [5] Khurshid, K, Irteza, S, and Khan, A. A., "Application of ant colony optimization based algorithm in MIMO detection", *CEC10 - IEEE Congress on Evolutionary Computation*, pp. 17, 2010.
- [6] Jos Carlos, M and Taufik, A., "Lattice reduction aided detector for MIMO communication using Ant colony optimization", *Wireless Personal Communications*, Springer, 77(1):63-85, 2013.
- [7] Khawaja Tauseef Tasneem, "Reduced complexity detection techniques for multi antenna communication systems", Ph.D. Thesis, University of Canterbury, New Zealand, 2013.
- [8] Kailath, T, Vikalo, H, and Hassibi, B., "MIMO Receive algorithms, Space-Time Wireless systems: From Array processing to MIMO Communications", Cambridge University Press, 2005.
- [9] Ayyoub, A. M, Sabira, K, Borhanuddin, M. A, Raja S. A. R, Abdullah., "QoS based fair load-balancing: Paradigm to IANRA Routing algorithm for wireless networks", *Proceedings of 11th International Conference on Computer and Information Technology*, Bangladesh, 2008.
- [10] Lain, J. K and Lai, J. J., "Ant Colony Optimisation-Based multiuser detection for Direct-Sequence CDMA Systems with diversity reception", *IET Communications*, 1(4): 556561, 2007.
- [11] Vincent Poor, H., "An Introduction to signal detection and estimation", 2nd edition, Springer-Verlag, 1994.
- [12] Gopi, E. S., "Algorithm collections for digital signal processing applications using matlab", Springer, 2007.
- [13] Rakesh, R and Jyotishree, "Blending Roulette wheel selection and Rank selection in Genetic Algorithms", *International Journal of Machine Learning and Computing*, Vol. 2, No. 4, August 2012.

B. Rebekka is currently working as Assistant Professor in the Department of Electronics and Communication Engineering at National Institute of Technology, Tiruchirappalli, Tamilnadu, India. She obtained the M.Tech. degree in Advanced Communication Systems from SASTRA Deemed University, Thanjavur, Tamilnadu, India in the year 2005 and B.E. degree in Electronics and Communication Engineering from Bharathiar University, Coimbatore, Tamilnadu, India. Her research interests include Quality of Service scheduling in wireless networks and Energy efficient communication.