

Multifunctional Electrical Outlet based on Mobile Ad Hoc Network

Toshihiko Sasama, Takao Kawamura, and Kazunori Sugahara

Abstract—Nowadays, new home appliances and office appliances have been developed that communicate with users through the Internet, for remote monitor and remote control. However, developments and sales of these new appliances are just started, then, many products in our houses and offices do not have these useful functions. In few years, we add these new functions to the outlet, it means multifunctional electrical power socket plug adapter. The outlet measure power consumption of connecting appliances, and it can switch power supply to connecting appliances, too. Using this outlet, power supply of old appliances can be control and monitor. And we developed the interface system using web browser to operate it from users[1]. But, this system need to set up LAN cables between outlets and so on. It is not convenience that cables around rooms. In this paper, we develop the system that use wireless mobile ad hoc network instead of wired LAN to communicate with the outlets.

Keywords—outlet, remote monitor, mobile ad hoc network, zigbee.

I. INTRODUCTION

IN recent years, many intelligent appliances in home and office have been developed. In many cases, they have functions of measurement, switching, and telecommunication, and users can access to these appliances through the Internet, and remote control. However, because of they do not have spread standard API, we need different connection methods and user interfaces for each appliances. And it is not only exist such new appliances, many part of appliances are old type appliances in now. They do not have some functions of telecommunication and so on. Then we have been developed the outlet that include simple functions of electrical power measurement, electrical power switching, and telecommunication[1] [2]. It is a electrical power socket plug adapter of palmtop box shape, that connect between a wall socket and an appliance plug, and this box have a more one cable to telecommunication. Since, this system need LAN cables around the room to connect outlets and router, and set up costs increase. In this paper, we develop the system using wireless mobile ad hoc network to communicate between outlets without LAN cables. Only one outlet connect to router of the house, and communicate to the service server of this system on the Internet. Users access to the service server from web browsers that is the remote monitor and controller of all outlets.

This system is useful for energy saving, and security monitoring of children and senior citizens, too. In this paper, we describe the system configuration in section II, and experiment results in section III, and finally describe conclusion.

T. Sasama, T. Kawamura, and K. Sugahara are with the Course of Information and Electronics, Graduate School of Engineering, Tottori University, Tottori, Japan. e-mail: {sasama,kawamura,sugahara}@ike.tottori-u.ac.jp

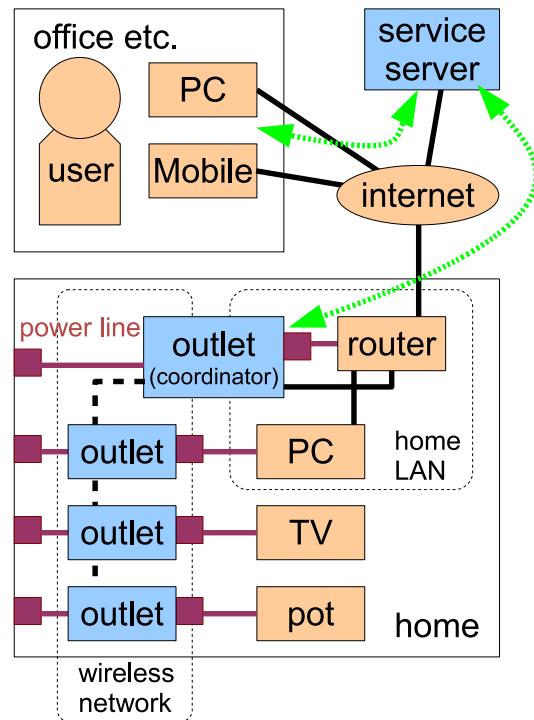

Fig. 1. Network configuration of proposed system

II. SYSTEM

Our developed system is constructed from 2 parts, outlets and the service server. Outlets are mounted on each wall socket and power strip in rooms, and watch connected appliances and switch power supply to it. The service server collect these information from outlets, and send control commands to the outlet. This server has a function of web server, users access this site from web browsers and control their appliances.

A. Network Configuration

Fig.1 shows the network configuration of this system. Each outlets communicate with other outlets using mobile ad hoc network, and only one outlet that called a coordinator is connect to the Internet. The coordinator behaves like a proxy to other outlets, and do polling from inside of LAN to avoid firewall problems. It collect logs of electrical power consumption from outlets, send logs to the service server, and receive and relay electrical power supply switching commands from the service server.

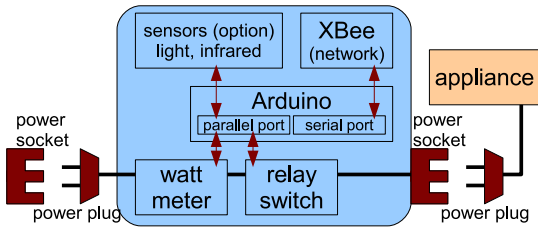

Fig. 2. Configuration of the multifunctional electrical outlet

B. Outlet Configuration

Fig.2 shows the configuration of this systems outlet. The outlet used the Arduino made by Smart Projects, the current sensor CTL-6-V-Z made by U.R.D Co., and the relay GR2-1 made by OMRON Corp. For wireless ad hoc network communication, the outlet used XBee made by Digi International. The outlet box size is 70mm(W)x120mm(H)x40mm(D). Fig.3 shows the old version outlet. In this old version, the outlet used PIC18 built into the Ethernet controller made by Microchip Technology, and all outlets need to connect with a HUB or a router using LAN cables. XBee is one of ZigBee modules. It has short range and low power consumption. In some cases, we add a light sensor or an infrared sensor for security monitor or energy saving on it.

One of them is selected as the coordinator to bridge wireless ad hoc network and LAN. It send message from inside of LAN to the service server on the Internet at regular intervals. Because of low power module, if some shields like walls or furniture exist between outlets, XBee communication capacity rapidly falls. In other situation that large number of outlets are distributed in a building, capacity problem raised too. Then, the clustering/hierarchical routing approaches are used on wireless network[3]. Fig.4 shows an example of clustering of outlets. From strength of radio field of each outlets, outlets create some groups. In a room that furniture are not put on, outlets create one group, and if a piece of furniture that disturb radio is exist, outlets create two or more groups. In the other, if an attenuation of radio by a wall is small, outlets of up side and back side of a wall are joined and create one group. these group are called clusters. In each cluster, one of outlets is a cluster head, a cluster head collect information from outlets in own cluster. And, all information gather in the coordinator relayed by cluster heads.

They are simple functions, they do not control complex parameters and do not monitor detailed information, but in many cases these functions are a necessary and sufficient condition.

C. Service Server

This system has a web server function as graphical user interfaces for monitor and control of outlets. Users access this web site from web browsers, and control it.

Fig.5 shows the screen shot after login to this system. room maps and layouts of outlets can be shown. If click an outlet on maps, a monitor page of its outlet is open. Fig.6 shows the screen shot of monitor page, and Fig.7 shows screen shots of

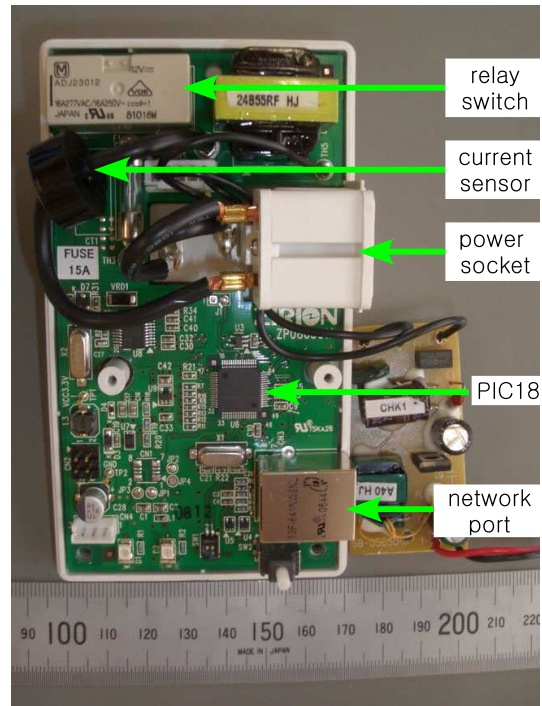

Fig. 3. old version outlet board (within Ethernet cable port)

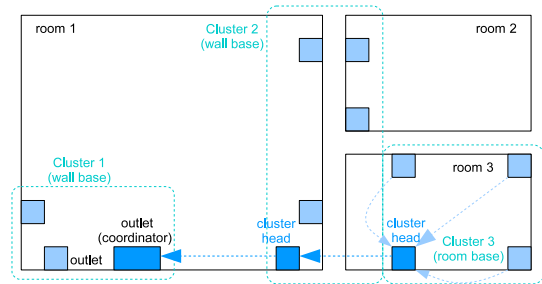

Fig. 4. clustering example of outlets



Fig. 5. Screen shot of a web browser displaying room map

switching page. a user can turn on/off power supply to target appliance from this page.

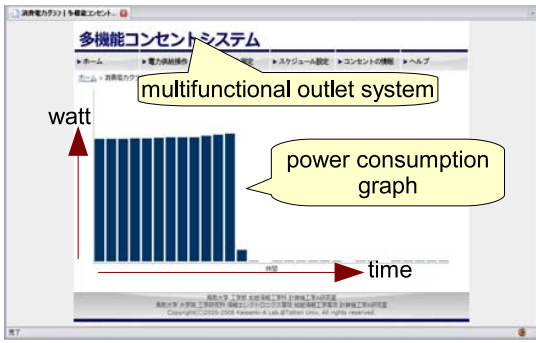

Fig. 6. Screen shot of a web browser displaying power consumption graph

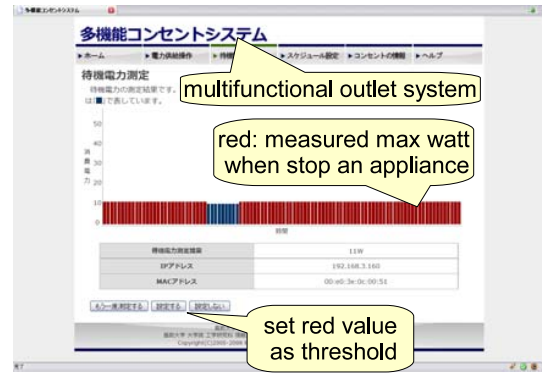

Fig. 8. Screen shot of a web browser to setup stop threshold of a PC

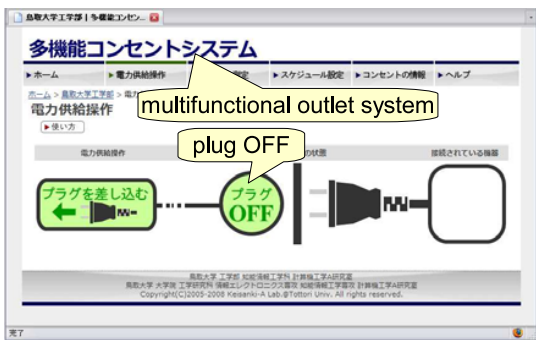
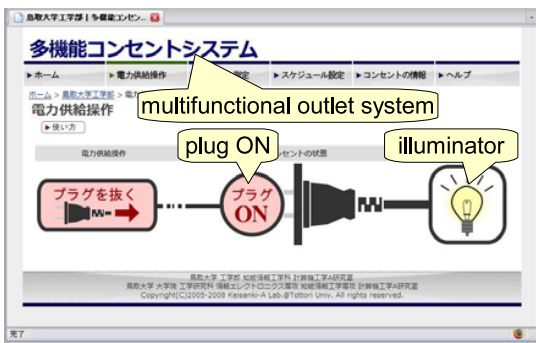

Fig. 7. Screen shots of a web browser to control power supply (ON/OFF)

D. Appliance Setting and Scheduling

In this system, outlets are logged electric power consumption. Using these logs, we can estimate easily what type appliance are connected on this outlet, and a status of the appliance is active/stop/sleep and so on. Many studies exist these pattern recognition and automatic estimation of appliances[4][5], and these estimations will be taken on future update, but now these set up are manually. When to set up the system, users set each appliance name and threshold-watt of active or stop on web browsers. Fig.8 shows the monitor of a connected PC when it was stopped. From this graph, while PC status is shutdown, it request 10W or 11W as a standby power consumption. It means, if a measured power consumption value is under 11W, connected PC status is shutdown, and if outlets stop power supply when this situation, it can save standby power consumption. Then, this system has the function of scheduling,

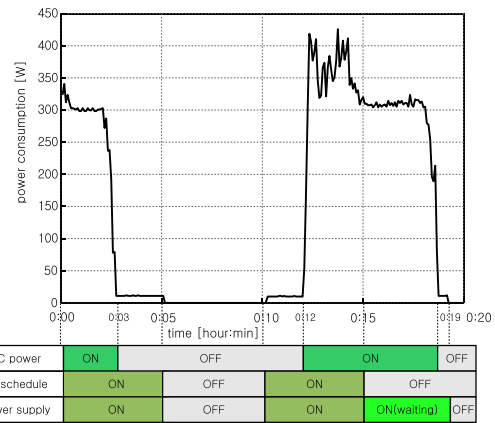

Fig. 9. Measured power consumption of a outlet connected a PC on schedule

too. In night time, the outlet check the power consumption in recent few minutes, and if it estimate connecting appliances do not use now, then turn off power supply until the morning. Fig.9 shows the experiment results of power consumption when the outlet take schedules of power cut time. In this experiment, schedules to stop power supply are from 0:05 to 0:10, and from 0:15 to 0:20. While scheduling time, the system check the power consumption and threshold, and stop power supply after PC was shutdown.

In the other side, these settings update the convenience of the system. For example, from monitors of a coffee pot in a kitchen and a bidet in toilets, a user can know house statuses such as children lunch and grandparents health in house from an office.

III. EXPERIMENT

We evaluated this system using an office of 3 months. In this office, about 20 people are working. All appliances in an office are connected to outlets, and in first 1 month are only monitoring without scheduling, and next 2 months are scheduled a power cut time. Many part of appliances are scheduled to power on during office time (from 6:00 to 21:00, weekday), and few appliances are power on all time. Scheduled appliances and its number are: a PC is 19, a monitor is 19, a printer is 2, fax is 2, and a microwave oven is 1. And

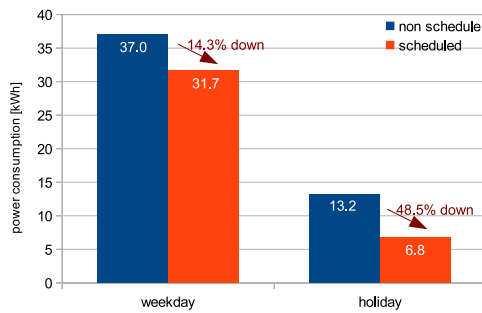

Fig. 10. Average power consumption per day

non scheduled appliances are: a HUB is 10, a fax is 1, and a refrigerator is 1. In this experience, we use old version outlets. Then 4 of 10 HUBs are for outlets, and connect LAN cables under floor.

Fig.10 shows averages of power consumption per day. This system worked without trouble. When to set scheduling, it saved standby electrical power consumption of appliances. On weekday, 14.3% was cut. And on holiday that scheduled many appliances are all day power off, 48.5% was cut. It means 19.1% was cut in each year.

Because of cable works are under floor, set up and remove of the system need some tasks and time. For same reasons, arrangement of appliances layout in an office is difficult. Some appliances like a cleaner have mobility, they move between power sockets sometimes. Then, new versions outlets need wireless connections and ad hoc network that can easily attached and detached appliances.

IV. CONCLUSION

In this paper, we developed the multifunctional electrical outlet that connect between a wall socket and appliance plugs. Using wireless mobile ad hoc networks, it became easy to set up of outlets and to follow up replacement of appliances. This systems control is web based. Outlets communicate to the coordinator in a house, and the coordinator communicate to the service server on the Internet. The service server has a function of web server, and users access this site and command to outlets from web browser. This system is useful for power saving and home security, too. In other words, this system can cut standby power of appliances, and can watch children in home indirectly.

To update these advantages, future works will be to add some sensors on the outlet that detect human activity, and to implement automatic estimation of connected appliances type and status of it.

REFERENCES

- [1] H. Akeyama, T. Kawamura, T. Sasama et al, *Multifunctional Electrical Outlet With Scheduling Functions to Reduce Standby Power Consumption*, IPSJ journal, Vol.51, No.12, pp.2287-2297, 2010 (in Japanese).
- [2] H. Akeyama, Y. Watani, T. Kawamura et al, *Multifunctional Outlet with Web Functions*, Xian University of Science and Technology and Tottori University, pp.3942, 2007.

- [3] T. Sasama, R. Monde, H. Masuyama, *Evaluation of K-Lattice-Clustering Algorithms for Random Wireless Multi-Hop Networks*, The 4th International Conference on Web Information Systems and Technologies, 2008
- [4] T. Saitoh, T. Osaki, R. Konisi et al, *Current Sensor Based Home Appliance and State of Appliance Recognition*, SICE Journal of Control, Measurement and System Integration (SICE JCMSI), Vol.3, No.2, pp.8698, 2010.
- [5] M. Ito, H. Omata, and S. Inoue et al, *A Method and System of Appliance Detection and Control Using Power Consumption Measurement*, IPSJ journal, Vol.48, No.9, pp.95-105, 2003 (in Japanese).