

Investigating the Dynamic Response of the Ballast

Osama Brinji, Wing Kong Chiu, Graham Tew

Abstract—Understanding the stability of rail ballast is one of the most important aspects in the railways. An unstable track may cause some issues such as unnecessary vibration and ultimately loss of track quality. The track foundation plays an important role in the stabilization of the railway. The dynamic response of rail ballast in the vicinity of the rail sleeper can affect the stability of the rail track and this has not been studied in detail. A review of literature showed that most of the works focused on the area under the concrete sleeper. Although there are some theories about the shear (longitudinal) effect of the rail ballast, these have not properly been studied and hence are not well understood. The stability of a rail track will depend on the compactness of the ballast in its vicinity. This paper will try to determine the dynamic response of the ballast to identify its resonant behaviour. This preliminary research is one of several studies that examine the vibration response of the granular materials. The main aim is to use this information for future design of sleepers to ensure that any dynamic response of the sleeper will not compromise the state of compactness of the ballast. This paper will report on the dependence of damping and the natural frequency of the ballast as a function of depth and distance from the point of excitation introduced through a concrete block. The concrete block is used to simulate a sleeper and the ballast is simulated with gravel. In spite of these approximations, the results presented in the paper will show an agreement with theories and the assumptions that are used in study the mechanical behaviour of the rail ballast.

Keywords—Ballast, dynamic response, sleeper, stability.

I. INTRODUCTION

THE track foundation is a crucial component to attaining a stable track. The ballast is one part of the overall foundation that is important for track stability. The dynamic behaviour of the ballast has been studied by several scientists. The model proposed in [1], [2] claimed that the ballast under each sleeper can be assumed to be independent of the others. Also, there are some theories and assumptions that are applied to the ballast under concrete sleepers which include the shear (longitudinal) effect in the foundation system [3]. One of these theories is the Ahlbeck's theory [4], which uses the trapezoidal shape as the shape of the stress distribution under the concrete sleepers as demonstrated in Fig. 1. The stress distribution angle (internal friction angle) of the rail ballast has an effect on the stiffness and the damping of the upper and the lower divisions of the rail ballast.

Osama Brinji is with the Monash University, Australia (e-mail: osama.brinji@monash.edu).

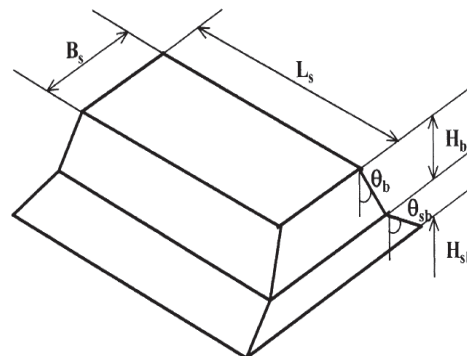

Fig. 1 The trapezoidal shape of the stress distribution under the rail sleeper of both divisions [4]

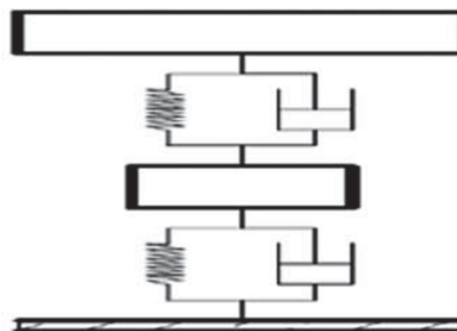

Fig. 2 The Ahlbeck's Model [4]

The model developed by Ahlbeck [4] considered the overall foundation in terms of a Lumped Mass Model. The nature of this model means that only the vertical effect of the sleeper and the ballast, as shown in Fig. 2, are considered. In addition, it was also reported that this model cannot be used in high-frequency vibration [3], [6]. In [4], it was reported that the stiffness value K_{bl} , as well as the mass of the trapezoidal part of the rail ballast under a sleeper M_{bl} can be expressed as:

$$k_{bl} = \frac{2 \tan \theta_b (L_s - B_s) E_b}{\ln \left[\frac{L_s (2 \tan \theta_b H_b + B_s)}{B_s (2 \tan \theta_b H_b + L_s)} \right]}$$

$$M_{bl} = \rho_b \left[2, B_s + H_b \tan \theta_b (L_s + B_s) + \frac{4}{3} H_b^2 \tan^2 \theta_b \right]$$

where θ_b is the internal friction angle of the rail ballast (Ahlbeck [4] recommended 20°), ρ_b is the rail ballast density, E_b is the modulus of elasticity of the rail ballast in N/m^2 , B_s and L_s , are

the width and length of the rail sleeper and H_b is the height of the ballast, as shown in Fig. 1.

Grassie [7] proposed a model that consists of two layers of continuous support. In this model, they used Euler-Bernoulli or Timoshenko beams resting on an elastic layer consisting of springs and dashpots to represent the rail track as well as the rail sleepers. Furthermore, Grassie [7] claimed that the vertical damping coefficients of the rail ballast and the sub-ballast are two-fifths of the critical damping coefficient of the system. Grassie [7] showed that the shear effect does not influence the rail ballast and the sub-ballast receptance. Also, Grassie [7] pointed out that the areas between or under the sleepers have the highest receptance at around 100 Hz for excitation. This finding is consistent with results from a field experiment conducted by Zhai [6]. Zhai's experimental results show that when the rail ballast is excited by frequencies ranging between 0 to 400 Hz, the highest correspondence of the rail ballast acceleration (about 0.175 g/Hz) occurs at around 100 Hz.

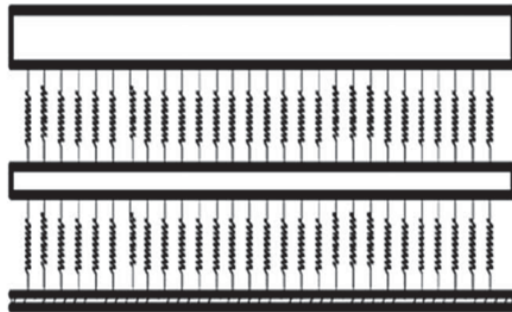

Fig. 3 The Grassie's Model [7]

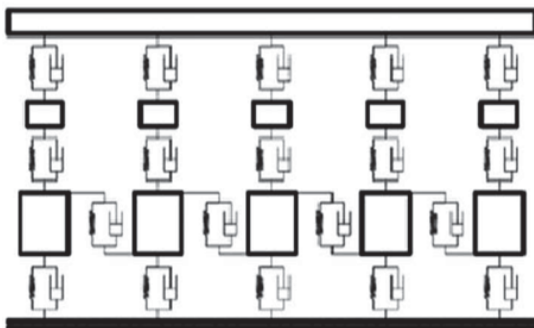

Fig. 4 The Sun and Dhanasekar's Model [5]

Sun and Dhanasekar [5] developed a model that considered the effects of shear (longitudinal) stiffness and damping of the rail ballast and the sub-ballast as demonstrated in Fig. 4. In this model, they established that the values of shear (longitudinal) stiffness and damping of the rail ballast and the sub-ballast to be the elements that connect every block of the rail and the sub-ballast in their respective layers under every sleeper. They reported that the coefficients of the shear spring and damping are one-third of the vertical ones. This is because this percentage is unresponsive to the dynamic responses on the interface between the wagon and the track. In other words, it

does not react to the vibration that is generated from the interface between the wagon and the track. Sun and Dhanasekar [5] also developed the equations of motion for all components, which include the stiffness and the damping of the rail ballast and sub-ballast, based on the basic dynamic equilibrium concept.

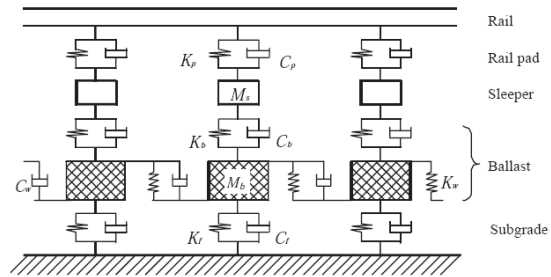

Fig. 5 The Zhai's Model [6]

Zhai [6] established a model similar to the Sun and Dhanasekar's model [5], as show in Fig. 5. Their work included a field experiment and their results agree well with those obtained from Ahlbeck's theory [4]. They found that there is an overlapping of adjacent ballast masses due to small sleeper spacing, or a big distribution angle in the thick layer of ballast, as illustrated in Fig. 6. The mass and stiffness due the overlapping effect will be:

$$M'_b = \rho_b [l_b h_b (l_e + h_b \tan \alpha) + l_e (h_b^2 - h_0^2) \tan \alpha + \frac{4}{3} (h_b^3 - h_0^3) \tan^2 \alpha]$$

$$K'_b = \frac{K_{b1} K_{b2}}{K_{b1} + K_{b2}}$$

$$K_{b1} = \frac{2(l_e - l_b) \tan \alpha}{\ln \left[\frac{l_e l_s}{l_b (l_e + l_s - l_b)} \right]} E_b$$

$$K_{b2} = \frac{l_s (l_s - l_b + 2l_e + 2h_b \tan \alpha) \tan \alpha}{l_b - l_e + 2h_b \tan \alpha} E_b$$

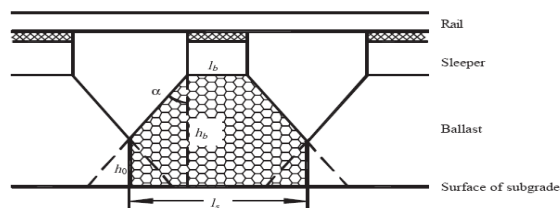

Fig. 6 The overlapping in the thick ballast [6]

Zhai [6] pointed out that the shear effect (stiffness and damping) should be taken into account in their model to ensure the continuity and the coupling effects of the interlocking ballast granules. They also outlined that the length of the rail beam should be long enough to reduce the boundary influence, and that determination of ballast damping coefficient is difficult.

In the work reviewed above [4]-[7], it is evident that the structural response of the track-ballast has been studied

extensively. These models are particularly useful when determining the dynamic response of a track structure. It also forms a good basis for the work presented in this paper. The focus of this paper is to determine the dynamic response of the ballast in the vicinity of the sleeper. The results presented included the dynamic response of the gravel (ballast) at various depths beneath a simulated concrete sleeper, and the corresponding dynamic response in shear (longitudinal) at different depths and distances.

II. TEST ARRANGEMENT

In the experiments reported in this paper, the ballast is simulated with gravel and a small scale concrete sleeper are used. The experimental results will be compared with Ahlbeck's theory [4]. The gravel was compacted prior to the experiment. An accelerometer (Vibra-Metrics Model 1022LF) was placed amongst the simulated ballast during the experiment. During the experiment, the concrete block is subjected to an impact using an instrumented impact hammer (see Fig. 7). Efforts were made to ensure that the excitation generated was sufficient to bring about a measurable response at the accelerometer positions. The transient response measured by the accelerometer were acquired using Pulse Reflex. The sample rate used in this experiment is 400-800 Hz, the number of lines is 400 lines and the span is 200-400 Hz. This frequency bandwidth used is consistent with that reported in work by [5], [6].



Fig. 7 The hammer impact

III. THE VERTICAL RESPONSE UNDER THE SLEEPER

In this part of the experiment, the results from Ahlbeck's theory [4] are used as a basis to verify the validity of our experimental setup. In this experiment, the accelerometer is located in the ballast at 150 mm under the concrete block as shown in Fig. 8.

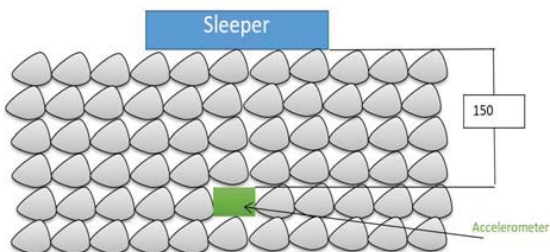

Fig. 8 Position of the accelerometer under the sleeper

According to an initial calculation based on the Ahlbeck's theory [4] discussed in the literature review, the stiffness of the gravel under the sleeper is $K_b = 35 \text{ MN/m}$ and the affected mass of the gravel under the sleeper is $M_b = 103.35 \text{ kg}$. The natural frequency, then has been determined by

$$W_n = \sqrt{\frac{K_b}{M_b}} = 92.57 \text{ Hz.}$$

The parameters used in this calculation are provided from either the supplier (density of the gravel=1750 Kg/m³), measured (the dimensions) or taken from [8] (modulus of elasticity of the gravel= 300 MPa).

The dynamic response is studied by applying an impulse input to the concrete block using an impact hammer. The transient response measured by the accelerometer was used to calculate the natural frequency of the ballast. Fig. 9 shows the function response obtained. From this result, the natural frequency of this system is calculated to be 114.5 Hz which is 18% higher than the one calculated from Ahlbeck theory. Using the half bandwidth method, the damping ratio is estimated as:

$$X_{\max}/\sqrt{2} = \frac{8.21}{\sqrt{2}} = 5.8 \text{ at } 83 \text{ and } 168 \text{ Hz}$$

$$\zeta = \frac{168-83}{2 \times 114.5} = 0.37.$$

The result shown in Fig. 9 agrees with the Grassie's theory [7]. Grassie used 40% of the critical damping ratio to be the vertical damping ratio under the sleeper. The agreement with results from works reported by Ahlbeck [4] and Grassie [7] provided confidence in the experimental test procedure used.

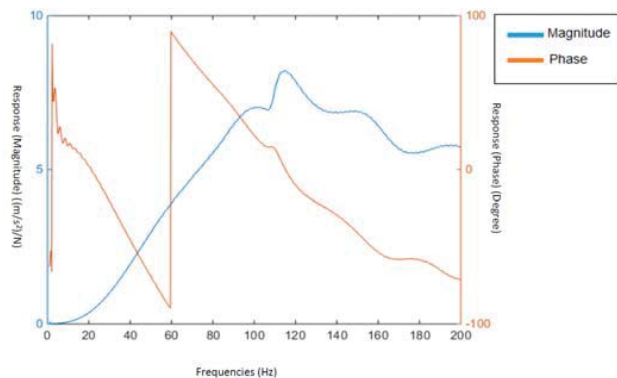

Fig. 9 The resulted response (magnitude and phase) at 150 mm under the sleeper

IV. THE EFFECT OF THE DEPTH ON THE DAMPING UNDER THE SLEEPER

This section studies the vibration response at different depths beneath the sleeper. In this part of the experiment, the responses of the ballast were considered at depths of 150, 100, 75 and 50 mm from the underside of the sleeper, as shown in Fig. 10. These measurement positions were located immediately below the simulated concrete sleeper where the accelerometers are placed.

The readings are taken at each depth separately to maintain the homogeneity of the gravel due to the size of the accelerometers. The results obtained are presented in Fig. 11. The natural frequencies and the damping ratio at each depth are shown in Table I.

TABLE I
NATURAL FREQUENCY OF BALLAST UNDER THE SLEEPER AT DIFFERENT DEPTHS

Depth (mm)	Natural Frequency (Hz)	Damping Ratio
50	117.5	0.36
75	115.0	0.40
100	114.5	0.39
150	114.5	0.37

From the results in Table I, it is noted that the natural frequency and the damping ratio of the gravel under the sleeper are not affected by the variation in the depth.

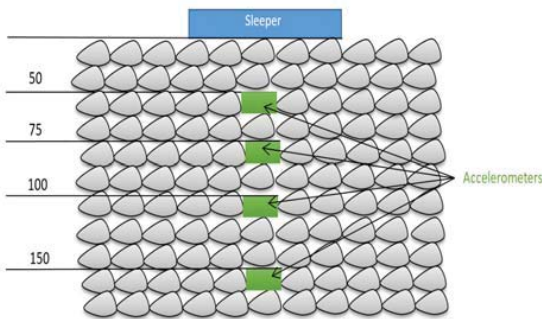

Fig. 10 Location of the accelerometers

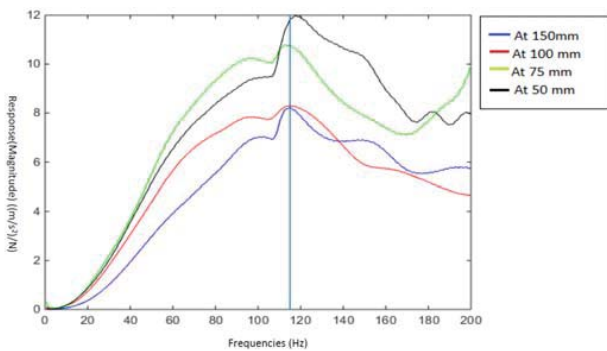

Fig. 11 The response (magnitude) at four different depths under the sleeper

V. THE LONGITUDINAL RESPONSE AT DIFFERENT DEPTHS

In this set of experiments, the vibration response for various depths at 350 mm distance from the sleeper in the longitudinal direction are reported. The accelerometers are located at depths 150, 100, 75 and 50 mm at a distance of 350 mm length from the sleeper, as shown in Fig. 12. As in previous experiments, the readings are taken at each depth separately to maintain the homogeneity of the gravel due to the size of the accelerometers.

Fig. 13 shows the corresponding frequency spectra of the gravel accelerations derived from the FFT transformation at

four different depths. The natural frequencies and the damping ratio at each depth are shown in Table II.

TABLE II
NATURAL FREQUENCY OF BALLAST AT VARIOUS DEPTHS AT 350 MM FROM THE SLEEPER IN SHEAR DIRECTION

Depth (mm)	Natural Frequency (Hz)	Damping Ratio
50	184	0.13
75	168	0.12
100	182	0.11
150	203	0.10

It is noted that the response in shear direction varied inversely with depth as shown in Table II. The excitation (response) increases when it goes deeper. This is due to the effect of the conic shape of the response under the sleeper. In other words, at 150 mm depth the accelerometer is at the shortest distance from the affected region under the sleeper, in contrast with shallow depths where this distance becomes longer and longer. It is found that the damping ratio at each depth is around one third of the vertical damping when comparing it with the damping ratio at the four different depths under the sleeper from the previous set (0.10, 0.11, 0.12 and 0.13 at depths of 150, 100, 75 and 50 mm respectively). This is consistent with the findings of Sun and Dhanasekar [5].

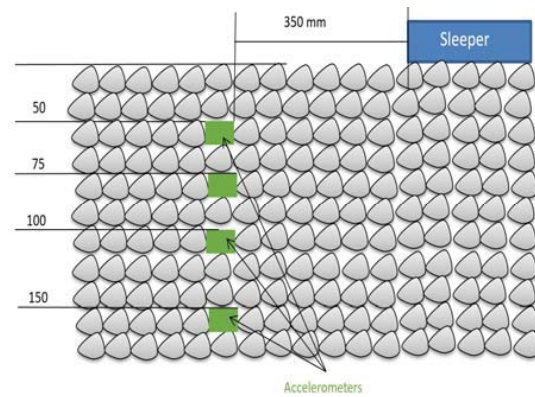

Fig. 12 Locations of the accelerometer

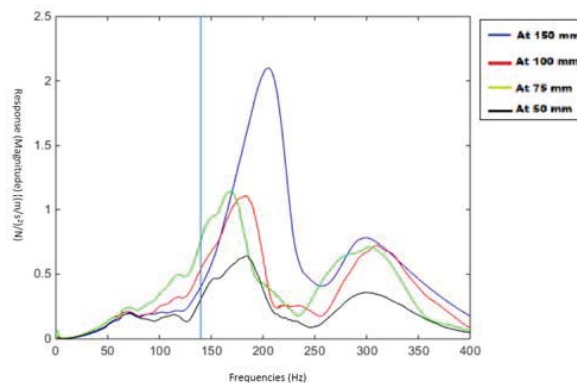

Fig. 13 The response (magnitude) of the gravel at four different depths in a longitudinal direction from the sleeper.

VI. THE EFFECT OF ALTERATION OF THE DISTANCE FROM THE SLEEPER ON THE LONGITUDINAL RESPONSE

The aim of this parcel of work is to analyse and compare the vibration response of the gravel at two various locations (with the accelerometer located on the surface of the ballast and at a depth of 150 mm). At each of these locations, the dynamic response at different distances from the sleeper (350, 450, 550, 650 and 750 mm) are determined (see Fig. 14). The readings are taken at each depth separately to maintain the homogeneity of the gravel due to the size of the accelerometers as for the previous sets.

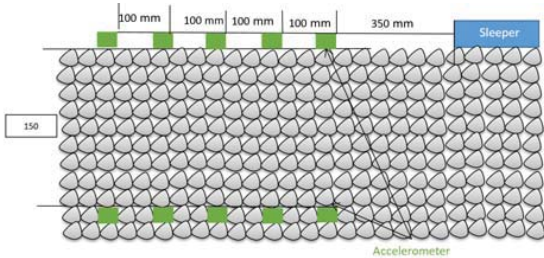

Fig. 14 The accelerometer locations

The accelerometers on top of the gravel were placed between the gravel particles as shown in Fig. 15. In this set, the changes of the natural frequencies, the damping ratios and the magnitude of the vibration responses at these locations are determined.



Fig. 15 The placement of the accelerometer on top of the gravel

TABLE III
NATURAL FREQUENCY OF BALLAST AT VARIOUS DISTANCES AT 150 MM DEPTH

Distance (mm)	Natural Frequency (Hz)	Damping Ratio
350	203	0.10
450	220	0.12
550	196	0.10
650	191	0.10
750	188	0.12

Table III shows the natural frequency and the damping ratio of the data from this set of experiments. It is shown that the natural frequency fluctuates around 200 Hz for each distance 350, 450, 550, 650 and 750 mm. Also, the damping is still approximately 30% of the vertical damping ratio, whatever the distance from the sleeper. Furthermore, the response of the

gravel decreases gradually with increasing distance, excluding at 450 and 550 mm, at a depth of 150 mm, where the responses are constant, as shown Fig. 16. Along with the previous set, this set confirms that the shear damping ratio is 30% of the vertical damping ratio under the sleeper.

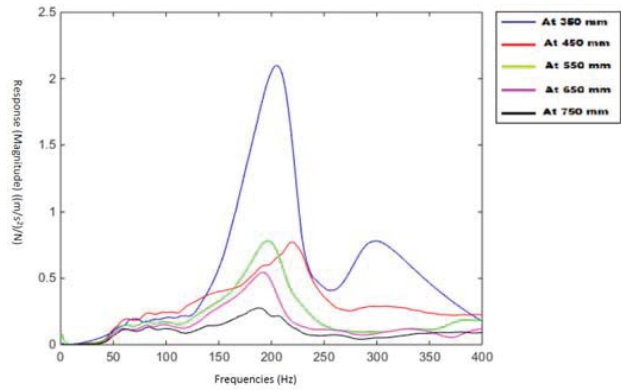

Fig. 16 The vibration response (magnitude) at 150 mm depth

On the surface of the gravel, the measured natural frequency is around 88 Hz (see Fig. 17). The damping ratio is around 0.22 of the critical damping (see Table IV). The response decreases gradually; however, it is higher than the response at 150 mm for all distances except 350 mm, due to the influence of the conic shape of the response under the sleeper as illustrated in Fig. 17. The results presented show that the natural frequency of the ballast is location dependent and may need to be taken into consideration when modelling the dynamic response of the rail-ballast structure.

TABLE IV
NATURAL FREQUENCY OF BALLAST ON THE TOP OF THE BALLAST AT VARIOUS DISTANCES

Distance (mm)	Natural Frequency (Hz)	Damping Ratio
350	91	0.22
450	88	0.19
550	85	0.25
650	85	0.20
750	90	0.27

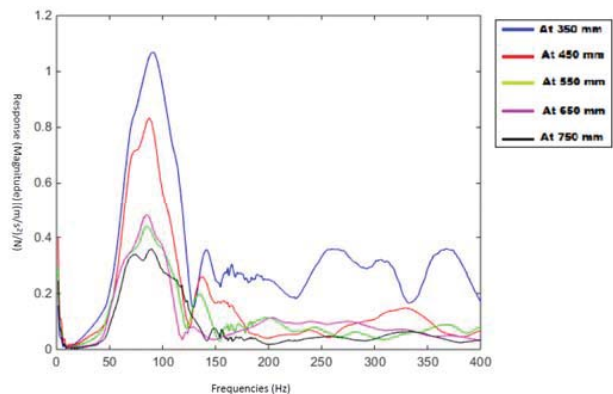

Fig. 17 The vibration response (magnitude) on top of the gravel

VII.CONCLUSIONS

This paper summarises the information about the vibration responses under a concrete sleeper, which is available in the literature. The main theories and the assumptions that are used to study the mechanical behaviour were summarised. Moreover, a small-scale experiment studying the vibration response of the gravel under shear (longitudinal) direction was undertaken and the results discussed.

It is found that:

- There is good agreement between the results obtained from the experiment and Ahlbeck's theory [4] and the assumptions reported by Sun & Dhanasekar [5] and Grassie [7] in terms of the vibration response of ballast (gravel) the damping ratio of the gravel underneath the sleeper and in shear (longitudinal) direction.
- The results presented show that the natural frequency of the ballast is location dependent and may need to be taken into consideration when modelling the dynamic response rail-ballast structure.

ACKNOWLEDGMENT

This research was undertaken as part of research, development and education conducted by Rail Manufacturing CRC (RMCRC), established and supported under the Australian Government's Cooperative Research Centres Program.

REFERENCES

- [1] Mazilu, T., *An Analysis of the Interaction between Two Wheels and a Discretely Supported Rail*. Annals of the Faculty of Engineering Hunedoara-International Journal of Engineering, 2013. 11(2).
- [2] Luo, Y., H. Yin, and C. Hua, *The dynamic response of railway ballast to the action of trains moving at different speeds*. Proceedings of the Institution of Mechanical Engineers, Part F: Journal of Rail and Rapid Transit, 1996. 210(2): p. 95-101.
- [3] Esmacili, M. and H.H. Noghabi, *Investigating Seismic Behavior of Ballasted Railway Track in Earthquake Excitation Using Finite-Element Model in Three-Dimensional Space*. Journal of Transportation Engineering, 2012. 139(7): p. 697-708.
- [4] Ahlbeck, D.R., H.C. Meacham, and R.H. Prause, The development of analytical models for railroad track dynamics, in *Railroad Track Mechanics & Technology*, A.D. Kerr, Editor. 1978, Pergamon Press: Oxford.
- [5] Sun, Y.Q. and M. Dhanasekar, *A dynamic model for the vertical interaction of the rail track and wagon system*. International Journal of Solids and Structures, 2002. 39(5): p. 1337-1359.
- [6] Zhai, W.M., K.Y. Wang, and J.H. Lin, *Modelling and experiment of railway ballast vibrations*. Journal of Sound and Vibration, 2004. 270(4-5): p. 673-683.
- [7] Grassie, S., et al., *The dynamic response of railway track to high frequency vertical excitation*. Journal of Mechanical Engineering Science, 1982. 24(2): p. 77-90.
- [8] Sitharam, T., M. Ramulu, and V. Maji, *Static and Dynamic Elastic Modulus of Jointed Rock Mass: Influence of Joint Frequency*. Joint. Geotechnical Applications for Earthquake Engineering: Research Advancements: Research Advancements, 2012: p. 110.

Osama Brinji master candidate at Monash University since 2014. Brinji graduated from King Abdul-Aziz University 2008 and work as Teaching Assisting at Taibah University since 2009.