

Highly Flexible Modularized Sensor Platform

Kai-Chao Yang, Chun-Ming Huang, Chih-Chiao Yang, and Chien-Ming Wu

Abstract—Sensors have been used in various kinds of academic fields and applications. In this article, we propose the idea of modularized sensors that combine multiple sensor modules into a unique sensor. We divide a sensor into several units according to functionalities. Each unit has different sensor modules, which share the same type of connectors and can be serially and arbitrarily connected each other. A user can combine different sensor modules into a sensor platform according to requirements. Compared with current modularized sensors, the proposed sensor platform is highly flexible and reusable. We have implemented the prototype of the proposed sensor platform, and the experimental results show the proposed platform can work correctly.

Keywords—Sensor device, sensor fusion.

I. INTRODUCTION

DUE to the continuous advancement of IC technology, sensors have become much cheaper and smaller. Nowadays, numerous consumer electronics devices use sensors to recognize environments and make decision. For robustness, most of these devices use more than one sensor. For example, an IMU (inertial measurement unit) usually contains gyroscope, accelerometer, and magnetometer inside. In addition, multi-sensor systems are also widely used in many academic topics, especially for sensor fusion [1]. Thus the development of sensor systems, especially multi-sensor systems, has become an important issue.

In the commercial market, a sensor module usually can sense only one feature [2]. For example, Fig. 1 (a) shows 10 sensor modules, each of which can recognize one feature in environments. To develop a new sensor for sensor fusion, a user has to combine various modules together. Alternatively, he can also use different sensors to sense multiple features, but this will increase the cost or lose accuracy. Because these self-made sensors are designed for specific purposes, they have little extendibility and reusability.

There are also products that divide a sensor node into wireless module and sensor boards, such as MicaZ [3] (Fig. 1 (b)). For different applications, users can stack different sensor boards on the wireless module, so the reusability is further increased. However, the architecture usually allows only one sensor board connecting with the wireless module. Although some sensor boards have multiple sensor modules, the flexibility is still confined.

Normally, a sensor node is made up of four basic

components, sensing unit, transceiver unit, processing unit, and power unit [4]. To develop a sensor node, these units are necessary. Our purpose is to provide a modularized sensor platform composed by sensor modules. Users can arbitrarily combine different modules with few constraints, such that he can create a unique sensor according to requirements. To achieve this objective, we follow the principle in [4], and include two new units, output unit and debug unit. Each unit has multiple sensor modules, which share the same type of connectors. The most significant feature is that most modules can be combined together concurrently. To build a sensor platform, a user can select required sensor modules and stack them one by one, just like building blocks. This feature makes the proposed platform highly flexible and reusable. Besides, it is suitable for sensor fusion applications which usually need to sense multiple features of an object.

Rest of this article is organized as follows. Section II describes the architecture of the proposed modularized sensor platform. Then we show the hardware implementation and demonstration in Section III. Finally, some future works are addressed in Section IV.

II. MODULARIZED SENSOR PLATFORM

A. Sensing Units

For the purposes of extensibility and reusability, we divide the sensor system into six units, output, sensing, transceiver, processing, power, and debug.

- 1) Output unit shows computational results and reminds users by visual or sound signal or vibration. When output unit is used, the sensor can work independently without sending computational results to the server. In this situation, transceiver unit is not necessary.
- 2) Sensing unit is the main component of the sensor platform to recognize surrounding environments, such as accelerometer, compass, and thermometer.



Fig. 1 (a) Ten different sensor modules; (b) MicaZ wireless module and a sensor board

K.-C.Yang is with the National Chip Implementation, Hsinchu, Taiwan (corresponding author to provide phone: +886-577-3693; fax: +886-668-7035; e-mail: kcyang@cic.narl.org.tw).

C.-M. Huang and C.-Chiao Yang are with the National Chip Implementation, Hsinchu, Taiwan (e-mail: cmhuang@cic.narl.org.tw; ccyang@cic.narl.org.tw).

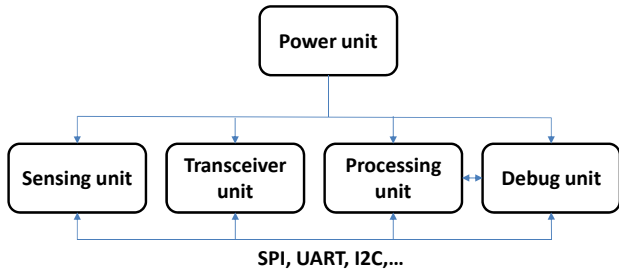

Fig. 2 Architecture of the proposed sensor platform

- 3) Transceiver unit is used for communication. It can receive commands, transmit results, and relay messages. For short range applications, ZigBee or Bluetooth could be used. As for long range applications, GSM could be used.
- 4) Processing unit is in charge of executing hardware or software commands. In sensor fusion, processing unit has to integrate several sensing data and make decisions according to analysis results. A processing unit can be a MPU, a FPGA, or a controller.
- 5) Power unit provides power to all other units. A power unit can be, for example, Li-Ion battery, button cell battery, or car charger.
- 6) Debug unit provides debug functions. When a sensor module is stacked on the debug unit, the designer can check signals of each pin and download codes from PC.

Some current sensor platforms such as MicaZ also divide a sensor node into several units, but they combine transceiver unit, processing unit, and power unit into one mixed unit, and thus the flexibility is reduced.

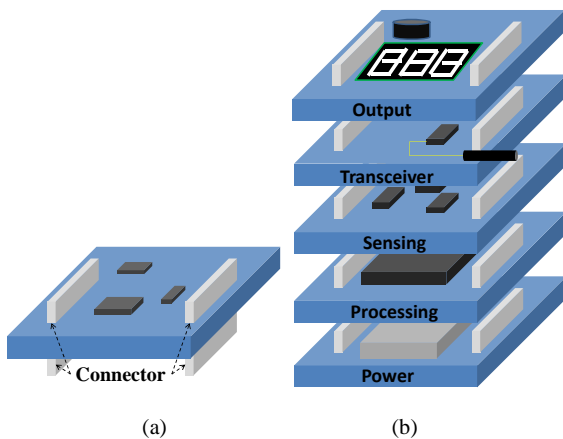

Fig. 3 (a) The sensor board and connectors of the proposed sensor platform; (b) an example of the proposed sensor platform composed by different sensor units

The architecture of the proposed sensor platform is shown in Fig. 2. The power unit supplies power to all units through a power line. The signals of sensing unit and transceiver unit are treated as peripheral signals, so they are connected with processing unit via SPI, I2C, or UART buses. Note that the power line and all buses are integrated to a universal connector that connects all units together. Besides the peripheral signals,

remaining signals of the processing unit are sent to the debug unit.

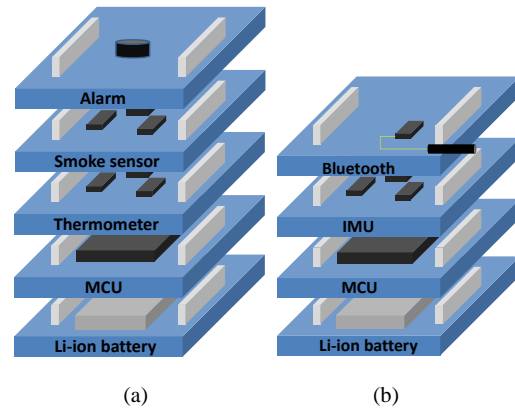

Fig. 4 Two examples of combinations of different modules (a) fire alarm; (b) AHRS

B. Sensor Modules

Each unit of the proposed sensor platform has multiple modules. For example, transceiver unit may have Bluetooth module and Wi-Fi module, sensing unit may have compass module and thermometer module, and power unit may have Li-Ion battery module and button cell battery module.

By using ordinary modularized sensors [3], [5], users can also select different sensor modules, but each time only one sensor modular board can be combined with the wireless module. In the proposed sensor platform, every module is implemented on an equal-size sensor board which has connectors on both front side and back side, such that different boards can be stacked each other, as illustrated in Fig. 3 (a). Here two connectors are used in order to increase the stability of the architecture. Fig. 3 (b) shows the combination of an output unit, a transceiver unit, a sensing unit, a processing unit, and a power unit. Thanks to the universal connector, different modules can be combined concurrently.

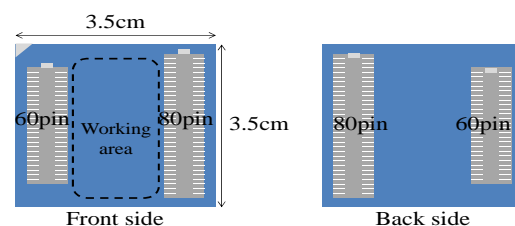

Fig. 5 Brief layout of a sensor module

C. Examples

The proposed sensor platform allows multiple modules being combined together. Thus the flexibility can be improved. In Fig. 4, we use two examples to show how they are stacked.

- 1) Fig. 4 (a) is a fire alarm. Two sensing modules are used in this sensor platform. Normally, either a smoke sensor or a thermometer can be used to detect fire, but there is limited accuracy. To reduce the probability of false alarm, the

sensing information of both sensors should be fused to make more precise decisions. As long as fire is detected, the sensor can notify users by the alarm module. This sensor platform can work independently without transceiver unit.

- 2) Fig. 4 (b) shows an IMU (Inertial Measurement Unit) sensor platform that detects rotation, acceleration, and gravitational force of an object. The IMU module itself is a multi-sensor module, consisting of an accelerometer, a gyroscope, and a magnetometer. This platform has no output unit, so it transmits computational results via the Bluetooth module.

III. PROTOTYPE

We have implemented several modules to demonstrate the proposed architecture.

Each sensor module follows the layout of Fig. 5. There is a pair of 60-pin and 80-pin header connectors on the front side and another pair of 60-pin and 80-pin receptacle connectors on the back side. Thus different modules can be serially stacked each other. Actually, only 63 pins of the connectors are used, so the connector size might be further reduced in the future. The area between two connectors on the front side is reserved for sensor components. The connector height and PCB thickness are 0.3cm and 0.15cm, respectively. These two values determine the total height of the sensor after combination of multiple modules. Considering the tradeoff between miniaturization and hardware complexity, the board size is set to 3.5cm×3.5cm finally. This size is suitable for being attached on objects and carried by persons.

Fig. 6 shows the appearance of several modules. In Fig. 6 (a), the left figure is the front side of the sensor board and the right one is the back side of the sensor board. This figure shows a mixed module with both MCU and Bluetooth module. This mixed module will be separated to a MCU module and a Bluetooth module in the future. Here we use MSP430 for the MCU module and PAN1325 for the Bluetooth module. The reasons to choose MSP430 are low cost and low power, corresponding to the requirements of sensing applications. The left side of Fig. 6 (b) is an IMU module that integrates L3GD20 gyroscope, ADXL345 accelerometer, and HMC5883L magnetometer. The right side of Fig. 6 (b) is a 3-axis accelerometer using ADXL345. These two sensor modules can be used to measure velocity, acceleration, direction, and rotation. They have been widely used in smart phones and vehicles. Fig. 6 (c) is a button cell battery module using CR2032 button cell battery. Besides, we also provide Li-ion battery module and USB charger module for replacement. Note that our power module has to be placed on the bottom, so there are no connectors on the back side. Fig. 6 (d) is the debug module for developers. There are external power supply, USB, JTAG, and other connectors on the board.

Except the debug module, the size of every module is 3.5cm×3.5cm, and the height is roughly 0.3cm. Some power modules are 1cm height when the battery is embedded. Fig. 7 shows an example that combines three modules together.

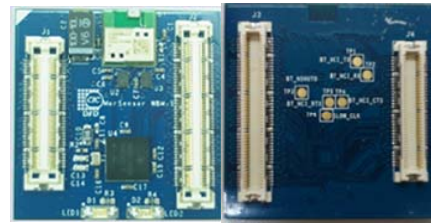

(a)

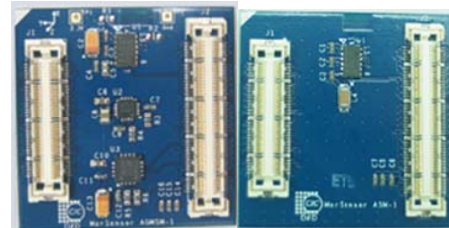

(b)

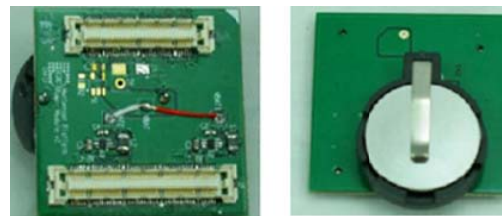

(c)



(d)

Fig. 6 The prototype of proposed modularized sensor platform (a) Front side (left) and back side (right) MCU and Bluetooth module; (b) 9-axis IMU module (left) and accelerometer module (right); (c) front side (left) and back side (right) of button cell battery module; (d) debug module

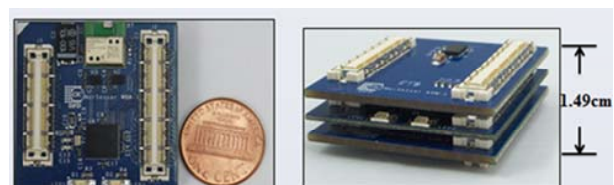

Fig. 7 Size of the module and combination of modules

To demonstrate that the hardware can work correctly, we combine the 3-axis accelerometer module, Bluetooth and MCU module, and button cell battery together to build a vibration detection sensor. This sensor can be attached on the object to detect if the vibration exceeds the maximum tolerant value. In

this sensor, the 3-axis accelerometer module is used to detect vibration and acceleration. The MCU module has to determine the sensed signals belong to noise, acceleration, or vibration. Besides, the sensed signals are transmitted to tablet PC, so that the user can monitor the situation. An alarm will be triggered if there is serious vibration. Fig. 8 shows the combined sensor modules and sensed signals on the software user interface, respectively. The signals are generated by knocking the table. The user interface is also modularized as functions in the library, so that users can use function call to create their own user interface.

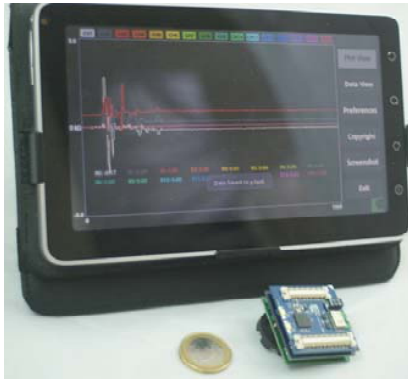

Fig. 8 User interface on the tablet PC

IV. CONCLUSION

In this article, we propose a novel architecture of modularized sensor platform. The most significant features of the proposed architectures are high flexibility and reusability. By stacking different modules together, users can create their own sensors. Our prototype demonstrates that the proposed architecture can work correctly. In the future, we focus on developing more modules and reducing sensor size. Besides, we also need to develop reference codes and software modules, such that users can easily control their sensors.

ACKNOWLEDGMENT

This work is supported in part by National Science Council of Taiwan. The authors thank Yu-Tsang Chang, Chun-Yu Chen, and Shian-Wen Chen.

REFERENCES

- [1] W. Elmenreich, "An introduction to sensor fusion," in *Research Report 47/2001*, Technische Universität Wien, Institut für Technische Informatik, Treitlstr. 1-3/182-1, 1040 Vienna, Austria, 2001.
- [2] Available: <https://www.sparkfun.com/categories/23>
- [3] Available: <http://bullseye.xbow.com:81/Products/productdetails.aspx?sid=164>
- [4] I. F. Akyildiz, S. Weilian, Y. Sankarasubramaniam, and E. Cayirci, "A survey on sensor networks," in *IEEE Communications Magazine*, vol. 40, no. 8, pp. 102-114, Aug. 2002.
- [5] C.-J. Chang and J.-P. Sheu, "Design and Implementation of Wireless Sensor Network Platform: Octopus X," in *Proceedings of Workshop on Wireless, Ad Hoc, and Sensor Networks (WASN)*, Hsinchu, Taiwan, Sep. 2009.