

Generalized Maximal Ratio Combining as a Supra-optimal Receiver Diversity Scheme

Jean-Pierre Dubois, Rania Minkara, and Rafic Ayoubi

Abstract—Maximal Ratio Combining (MRC) is considered the most complex combining technique as it requires channel coefficients estimation. It results in the lowest bit error rate (BER) compared to all other combining techniques. However the BER starts to deteriorate as errors are introduced in the channel coefficients estimation. A novel combining technique, termed Generalized Maximal Ratio Combining (GMRC) with a polynomial kernel, yields an identical BER as MRC with perfect channel estimation and a lower BER in the presence of channel estimation errors. We show that GMRC outperforms the optimal MRC scheme in general and we hereinafter introduce it to the scientific community as a new “supra-optimal” algorithm. Since diversity combining is especially effective in small femto- and pico-cells, internet-associated wireless peripheral systems are to benefit most from GMRC. As a result, many spinoff applications can be made to IP-based 4th generation networks.

Keywords—Bit error rate, femto-internet cells, generalized maximal ratio combining, signal-to-scattering noise ratio.

I. INTRODUCTION

Multipath fading caused by scattering of the transmitted signal is the major problem encountered in wireless communication systems. However, we can take advantage of multipath propagation by processing the returns of multiple multipath signals between the transmitter and the receiver in order to improve the signal-to-noise ratio (SNR). Diversity techniques extract multiple signal branches from different paths and process them (Single Input Multiple Output systems) to improve the performance of wireless systems. Maximal Ratio Combining (MRC) is an example of combining techniques that is proven to be the optimal multichannel receiver in the sense that it minimizes the mean square error (MMSE). This technique is considered complicated as it requires SNR estimation algorithm. Two cases can be explored: perfect channel states information and imperfect channel states information. The performance of MRC under imperfect channel state information starts to deteriorate as the estimation error is increased. In our work, a novel combining technique termed Generalized Maximal Ratio Combining (GMRC) is introduced. GMRC and MRC yield identical bit error rate (BER) in the case of perfect channel states information, and as errors are introduced into

the estimation of channel coefficients, GMRC results in a better performance.

II. GENERALIZED MAXIMAL RATIO COMBINING

GMRC is a generalized form of MRC. In MRC, the signals received from each diversity path are weighted by a coefficient α_i and then they are summed [1]. The same process (illustrated in Fig. 1) applies for GMRC with different weighting coefficient α_i .

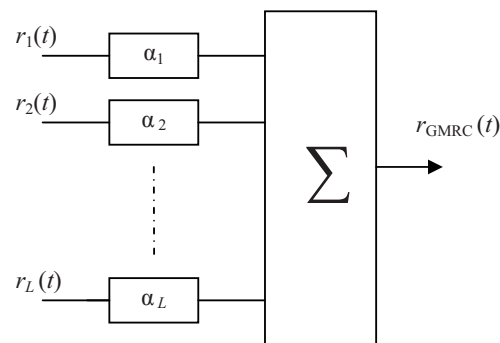

Fig. 1 GMRC combiner

Assuming that the original transmitted signal is $x(t)$, the output signal after applying GMRC is

$$r_{GMRC}(t) = \sum_{i=1}^L \alpha_i r_i(t) = \sum_{i=1}^L \alpha_i (x(t) n_i(t)) \quad \gamma \quad (1)$$

where γ_i and $n_i(t)$ are respectively the fading envelope and the additive noise of the i^{th} path. The weighting coefficients are:

$$\alpha_i = \frac{g(\gamma_i)}{\sqrt{\sum_{i=1}^L g^2(\gamma_i)}} \quad (2)$$

Using the polynomial kernel $g(\gamma_i) = \gamma_i^{n/2}$, the weights become

Manuscript submitted April 2010.

J. Dubois (J. Daba), R. Minkara, and R. Ayoubi are with the Elec. Engr. Dept., University of Balamand, Lebanon (e-mail: j.daba@balamand.edu.lb, rania.m.minkara@balamand.edu.lb, rafic.ayoubi@balamand.edu.lb).

$$\alpha_i = \frac{\sqrt{\gamma_i^n}}{\sqrt{\sum_{i=1}^L \gamma_i^n}}, \quad (3)$$

$$\sum_{i=1}^L \alpha_i^2 = 1. \quad (4)$$

If $n = 2$ the coefficients are

$$\alpha_i = \frac{\gamma_i}{\sqrt{\sum_{i=1}^L \gamma_i^2}}, \quad (5)$$

and MRC is thus obtained.

III. SIGNAL-TO-SCATTERING NOISE RATIO

We introduce a new performance metric, the signal-to-scattering-noise ratio (SSNR), that captures the “amount” or “degree” of fading. The SSNR is defined as

$$\text{SSNR} = \frac{E(\beta^2)}{\sigma_{\beta^2}} \quad (6)$$

SSNR corresponds to the reciprocal of speckle contrast in active radar imagery [2-9]. A large SSNR signifies that the signal’s power level fluctuations are small relative to the mean signal’s power strength, indicating “reliable” communication.

For GMRC, the fading power is

$$\gamma_{\text{GMRC}}^2 = \frac{\left(\sum_{i=1}^L \gamma_i^{1+n/2} \right)^2}{\sum_{i=1}^L \gamma_i^n} \quad (7)$$

In order to optimize (maximize) the SSNR over n , the SSNR was plotted versus the parameter n for different types of fading power. The SSNR plot reached its maximum for the values of n in the domain [1.3, 3] for Rayleigh, Rician, and Nakagami- m fading. We later established that this result applies to any type of fading statistics [2-9]. Although no proof of this result is established, it is left as a *conjecture* for researchers to prove in the future. We believe though that it is unlikely that a solid theoretical proof exists for this conjecture and that only a disproof in the form of a simulated counterexample could be presented, in the unlikely case where someone shows the existence of a fading stochastic model for which the conjecture fails. We claim for now that the same performance is achieved for all values of n between 1.3 and 3. Fig. 2 shows a sample of the SSNR plot versus n for a Rayleigh fading with average diffuse power equal to 10 and 4 diversity antennas.

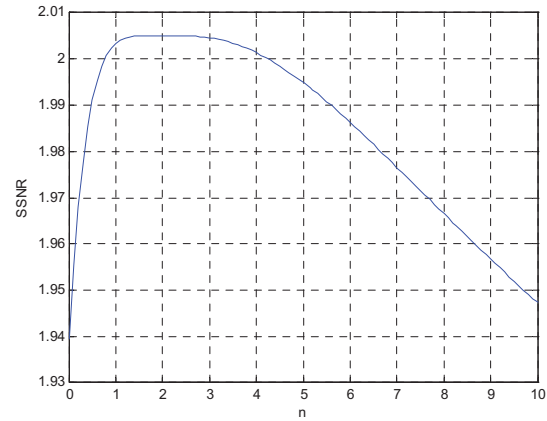

Fig. 2 SSNR versus n

Since MRC is sensitive to channel estimation errors, the cases where $n \leq 2$ are of special interest. For imperfect channel state information, estimation errors will occur on the channel coefficients. When applying MRC, we would be effectively squaring estimation error terms, whereas if we tune n to a value less than 2 (but more than 1), the estimation error will have a less significant effect.

Accordingly, with perfect channel state information, $n = 1.3$ (GMRC) and $n = 2$ (MRC) produce the same BER, whereas with imperfect channel state information, $n = 1.3$ outperforms $n = 2$.

We also suggested in prior research to make use of a near-optimal diversity technique termed RMSGC (root-mean-square gain combining) [10-15] when an ideal channel environment is present. This is because RMSGC does not require estimation of the channel coefficients, at the cost of greater implementation complexity, which was proven in a sub-sequent study to be feasible using an efficient FPGA implementation [10].

IV. PERFORMANCE EVALUATION

Throughout the simulation, we consider BPSK over independent Rayleigh fading (slow and non frequency selective) diversity channels with AWGN. The average reference SNR is denoted by $\bar{\rho} = E_b P_{\text{diff}} / N_0$, where E_b is the energy per bit, P_{diff} is the average diffuse power, and $N_0/2$ is the AWGN power spectral density [1].

The simulated BER is plotted versus the average SNR (dB). The simulation showed that both GMRC ($n=1.3$) and MRC ($n=2$) yield identical BER with perfect channel state information (Fig. 3). In addition, the BER decreases as the SNR or the number of diversity antennas is increased.

In order to simulate imperfect channel state information, errors must be introduced into the fading power. The estimated fading power for the i^{th} path is

$$\hat{\gamma}_i^2 = \gamma_i^2 + \sigma_E e_i \quad (8)$$

where $\sigma_E e_i$ follows a normal distribution with zero mean and variance σ_E^2 . Note that whenever $\gamma_i^2 + \sigma_E e_i$ is negative, the result is rejected and a new estimation is generated to conform with practical real life situations.

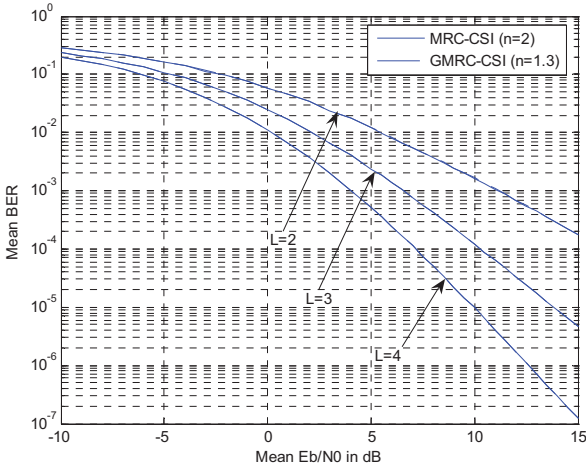

Fig. 3 BER for MRC ($n=2$) and GMRC ($n=1.3$) in a Rayleigh fading environment ($P_{dif}=1$) with perfect channel estimation for 2, 3 and 4 diversity antennas

Considering a low estimation error standard deviation ($\sigma_E = 0.01$), the resulting BER curves are shown in Fig. 4. The BER for GMRC ($n = 1.3$) and MRC ($n = 2$) is almost the same. At high SNR, the two curves start to deviate slightly. However as the estimation error standard deviation starts to increase ($\sigma_E = 0.1$ and $\sigma_E = 1$), this difference in BER curves starts to emerge and the BER of GRMC becomes lower than that of

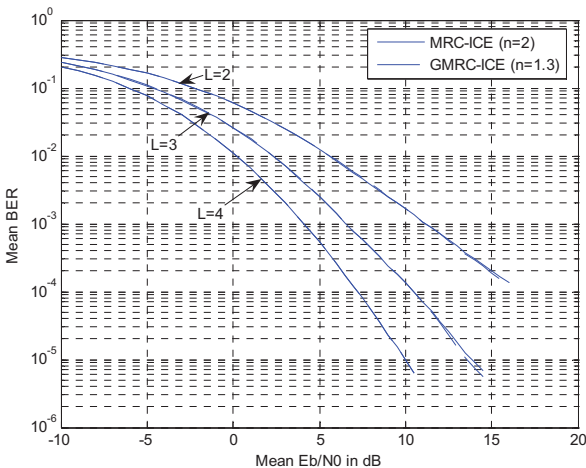

Fig. 4 BER for MRC ($n=2$) and GMRC ($n=1.3$) in Rayleigh fading environment ($P_{dif}=1$) with imperfect channel estimation ($\sigma_E=0.01$) for 2, 3 and 4 diversity antennas

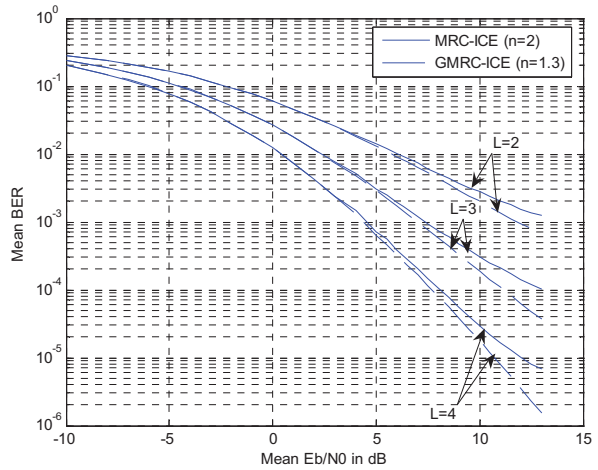

Fig. 5 BER for MRC ($n=2$) and GMRC ($n=1.3$) in Rayleigh fading environment ($P_{dif}=1$) with imperfect channel estimation ($\sigma_E=0.1$) for 2, 3, and 4 diversity antennas

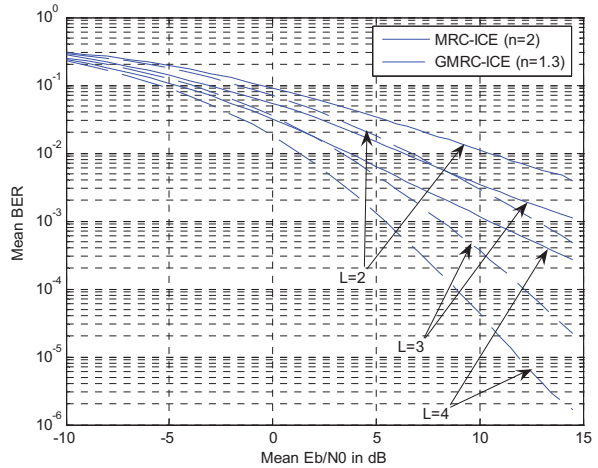

Fig. 6 BER for MRC ($n=2$) and GMRC ($n=1.3$) in Rayleigh fading environment ($P_{dif}=1$) with imperfect channel estimation ($\sigma_E=1$) for 2, 3, and 4 diversity antennas

MRC (Fig. 5 and Fig. 6). Moreover, as the number of diversity antennas is increased, the difference between the BER of GMRC and MRC becomes wider.

To clearly show the effect of the estimation error's standard deviation, the BER is plotted versus the standard deviation for the fixed SNR values: SNR = -5dB (Fig. 7) and SNR = 5dB (Fig. 8). As the standard deviation is increased, the BER is increased. Thus, the performance of both GMRC and MRC starts to deteriorate but GMRC maintains the lower BER. As the SNR gets higher, the improvement of GMRC over MRC becomes more and more significant.

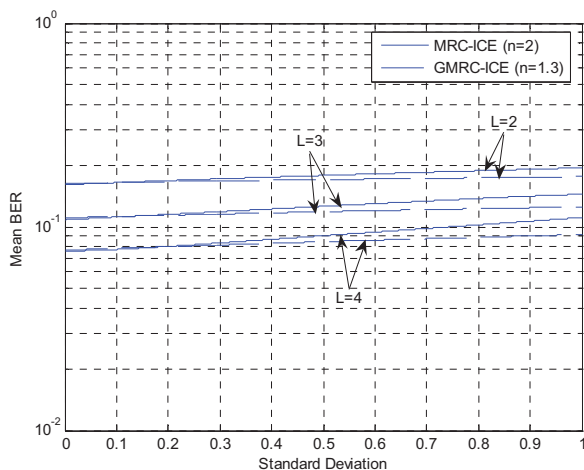

Fig. 7 BER for MRC ($n=2$) and GMRC ($n=1.3$) in Rayleigh fading environment ($P_{dif}=1$) at SNR=-5 dB with imperfect channel estimation for 2, 3, and 4 diversity antennas

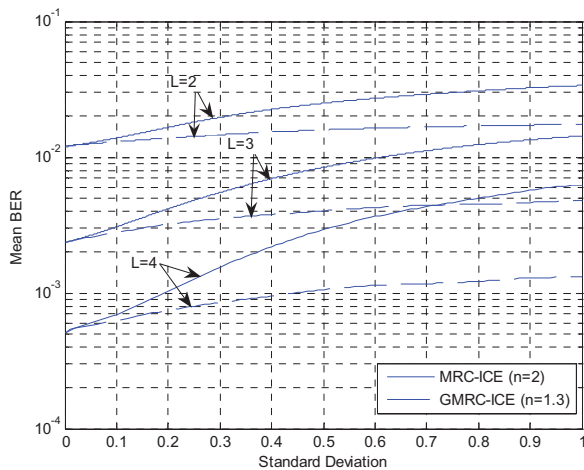

Fig. 8 BER for MRC ($n=2$) and GMRC ($n=1.3$) in Rayleigh fading environment ($P_{dif}=1$) at SNR=5 dB with imperfect channel estimation for 2, 3, and 4 diversity antennas

V. CONCLUSIONS

In this paper, we developed a new diversity combining technique termed GMRC corresponding to the power value $n = 1.3$ in the SSNR polynomial kernel. The performance of GMRC in terms of BER is identical to that of MRC (which corresponds to $n = 2$) when the estimation of the channel coefficients is considered ideal, i.e., without errors. However, once errors are introduced to the estimation algorithm, the performance starts to deteriorate and the BER of GMRC becomes lower than that of MRC.

With our introduction of this new supra-optimal receiver diversity combining technique, we make a revolutionary proposal to disregard the once considered optimal MRC technique and replace it by the Generalized-MRC. Since MRC was proven to underperform GMRC under imperfect channel

conditions, the best performance that MRC could produce is to equal that of GMRC under perfect channel conditions. And since the complexity of GMRC is identical to that of MRC in the sense that both require estimation of the fading channel coefficients, we see no justification for further utilization of MRC as a receiver diversity combining technique in wireless SIMO channels, and we hereto suggest that it be ubiquitously replaced by GMRC.

ACKNOWLEDGMENT

The authors acknowledge the financial support provided by a research grant from C.N.R.S., Bir Hassan, Beirut, Lebanon.

REFERENCES

- [1] T. Rappaport, *Wireless communications: principles and practice*, Prentice Hall Inc., NJ, 2nd edition, 2002.
- [2] J. Daba and M. Bell, "Statistics of the Scattering Cross Section of a Small Number of Random Scatterers," *IEEE Trans. on Antennas and Propagation*, August 1995.
- [3] J. S. Daba and M. R. Bell, "Statistical Distributions of Partially Developed Speckle Based on a Small Number of Constant Scatterers with Random Phase," *IEEE International Geoscience and Remote Sensing Symposium*, California Institute of Technology, Pasadena, CA, USA, August 8-12, 1994.
- [4] A. Abdi, S. Nader-Esfahani, J. Daba and M. R. Bell, "Comments on Statistics of the Scattering Cross Section of a Small Number of Random Scatterers," *IEEE Transactions on Antennas and Propagation*, vol. 48, no. 5, pp. 844-845, May 2000.
- [5] J. Dubois and P. Jreije, "Advanced Stochastic Models for Partially Developed Speckle," *5th International Conference on Computer, Electrical, and Systems Science, and Engineering (CESSE 2008)*, organized by the World Congress on Science, Engineering, and Technology, Vienna, Austria, August 2008.
- [6] J. Dubois, "Poisson Modulated Stochastic Model for Partially Developed Multi-Look Speckle," *American Conference on Applied Mathematics*, Harvard University, Cambridge, MA, USA, March 2008.
- [7] J. Dubois, "Scattering Statistics of Doppler Faded Acoustic Signals Using Speckle Noise Models," *IEEE International Conference on Direct and Inverse Problems of Electromagnetic and Acoustic Wave Theory*, Lviv, Ukraine, Sept. 2003.
- [8] J. Daba and M R. Bell, "Statistics of the Scattering Cross Section of a Collection of Constant Amplitude Scatterers with Random Phase," *West Lafayette, IN, Purdue University, School of Electrical Engineering Technical Report*, TR-EE 94-25, July 1994.
- [9] J. Daba and P. Jreije, "Probability Distributions for Multiplicative Noise in Internet Associated Wireless Cells and in Speckled Images," *Conference on Applied Mathematical Problems, Ukrainian Mathematical Congress*, Kiev, Ukraine, August, 2009.
- [10] R. Ayoubi, J. Dubois and O. Abdul-latif, "FPGA Implementation of a Novel Receiver Diversity Combining Technique," *IEEE International Conference on Signal Processing and Communications*, Dubai, Nov. 2007.
- [11] O. Abdul-Latif and J. Dubois, "LS-SVM Detector for RMSGC Diversity in SIMO Channels," *IEEE International Conference on Information Sciences, Signal Processing and its Applications*, Dubai, Feb. 2007.
- [12] J. Dubois and O. Abdul-Latif, "Novel Diversity Combining in OFDM-Based MIMO Systems," *American Conference on Applied Mathematics*, Harvard, Cambridge, MA, USA, 2008.
- [13] O. Abdul-Latif and J. Dubois, "Performance of UWB System in a Partially Developed Fading Channel with CCI," *5th IEEE GCC Communication and Signal Processing Conference*, Kuwait, March 2009.
- [14] J. P. Dubois, "Recent Advances in Wireless MIMO Sytems with Improved Receiver Diversity Combiners," in *Annual Review of Communications: Volume 60*, A. Sulluchuco, Editor, International Engineering Consortium (IEC), Chicago, USA, ISBN: 978-1-931695-59-6, pp. 513 – 527, 2007.

- [15] J. Daba and P. Jreije, "A Novel Receiver Diversity Combining Technique for Internet-Based 4G Wireless Communication", *The 9th International Conference on Signal Processing, Robotic and Automation (ISPRA'10)*, University of Cambridge, Cambridge, United Kingdom, February, 2010.