

Finite Element Analysis of Flush End Plate Moment Connections under Cyclic Loading

Vahid Zeinoddini-Meimand, Mehdi Ghassemieh, Jalal Kiani

Abstract—This paper explains the results of an investigation on the analysis of flush end plate steel connections by means of finite element method. Flush end plates are a highly indeterminate type of connection, which have a number of parameters that affect their behavior. Because of this, experimental investigations are complicated and very costly. Today, the finite element method provides an ideal method for analyzing complicated structures. Finite element models of these types of connections under monotonic loading have previously been investigated. A numerical model, which can predict the cyclic behavior of these connections, is of critical importance, as dynamic experiments are more costly. This paper summarizes a study to develop a three-dimensional finite element model that can accurately capture the cyclic behavior of flush end plate connections. Comparisons between FEM results and experimental results obtained from full-scale tests have been carried out, which confirms the accuracy of the finite element model. Consequently, design equations for this connection have been investigated and it is shown that these predictions are not precise in all cases. The effect of end plate thickness and bolt diameter on the overall behavior of this connection is discussed. This research demonstrates that using the appropriate configuration, this connection has the potential to form a plastic hinge in the beam-desirable in seismic behavior.

Keywords—Flush end plate connection, moment-rotation diagram, finite element method, moment frame, cyclic loading.

I. INTRODUCTION

BEFORE the 1994 Northridge earthquake, Welded Steel Moment-resisting Frames (WSMF) were widely used for multistory structures with minimal limitations; this was due to the assumption that the connections are fully rigid and stiff enough to resist seismic loads. In the 1994 Northridge earthquake, a number of steel moment resisting frames experienced brittle fractures in welded beam-to-column connections. Studies showed that these brittle failures happened more than the design probability of failure [1]. After this earthquake, once again bolted moment connections have seen a rise in popularity as engineers seek alternatives to the direct welded connections. The bolted end plate connections, as one of the fully restrained moment connections defined by the American Institute of Steel Construction (AISC), are extensively used for connecting beams to columns in multistory steel frame buildings as they are easily fabricated and erected. Bolted end plate connections are divided into two

categories: flush end plate and extended end plate. In both types a rectangular steel plate is welded to the end of a beam and then bolted to the column flange using one or more rows of high-strength steel bolts near the tension and compression flanges of the beam. In a typical flush end plate moment connection, in contrast to extended end plate connection, the rectangular steel plate is of nearly the same depth as the depth of the beam. Fig. 1 shows four configurations of typical flush end plate connections.

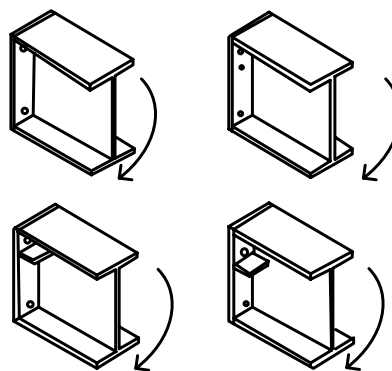

Fig. 1 Typical configurations for flush end-plate

Despite the popularity of the flush end plate connections, they represent a complex and highly indeterminate analytical problem with a number of parameters affecting their behavior. These parameters include column flange and web thicknesses, end plate thickness, beam depth, bolt size, bolt grade, and bolt configurations. Also, the prying forces developed at the interface of column flange and end plate aggravates the problem.

Like other problems in the structural mechanics, there are two main methods to investigate the structural properties of flush end plate connections: experimental methods and numerical methods. Over the years many researchers [2]–[14] have done experimental tests to investigate the behavior of these connections. These tests are very costly and as a result numerical methods have been very desirable as an alternative powerful tool. The following reports on the experimental studies performed on these types of connections.

In order to evaluate the influence of tension bolts on the stiffness of a flush end plate connection and also to determine the impact of the end plate thickness on moment rotation characteristics and the end plate collapse mechanism, Phillips and Packer [4] studied end plate connections with two rows of tension bolts. To determine the required thickness of the end

V. Z. Meimand is with Department of Civil Engineering, Johns Hopkins University, Baltimore, MD, USA (e-mail: vahidzm@jhu.edu).

M. Ghassemieh and Jalal Kiani are with the School of Civil Engineering, University of Tehran, Tehran, Iran (e-mail: mghassem@ut.ac.ir jalalkiani@gmail.com).

plate, they suggested two failure mechanisms for an end plate with two rows of bolts. They also concluded that the influence of the second row of tension bolts is much less than previously estimated. Hendrick et al. [13] have developed an empirical equation to estimate the distance from the bolt line to the location of prying forces by performing experiments on flush end-plates. Borgsmiller and Murray [2] performed several experiments on flush end plate connections that led to a simplified method for design of end plate moment connections based on two limit states such as end plate yielding and bolt rupture. An experimental investigation of the seismic behavior of flush end plate joints was performed by Broderick and Thomson [3]. Broderick and Thompson tested eight beam-to-column sub-assembly specimens under monotonic and cyclic loading conditions and demonstrated a stable cyclic response up to a determinable rotation limit. Shi et al. [6] tested several beam-to-column bolted end plate connections (including flush and extended end plate connections) with various configurations under monotonic loading. They indicated that all these connections were characterized as semi-rigid by AISC. These experiments also concluded extended end-plate connections behave better in terms of strength and stiffness in comparison with flush end-plate connections.

In addition to the experimental research mentioned above, several numerical studies have been carried out on predicting the behavior of different types of end plate connections [8], [15]–[22]. A brief discussion of some of these works is presented in this section. Krishnamurthy [19] performed linear finite element analyses of extended and flush end plate connections. This study showed the importance of end plate bending, and its effect on the bolt forces in multiple rows. Abolmaali et al. [15] presented a nonlinear finite element model for the moment rotation relationship of a flush end plate connection. In the study performed by Bose et al. [18], the analytical results of unstiffened flush end plate steel bolted joints by the finite element method were in a good agreement with the experimental tests except for some inconsistency in the initial elastic range and final elastic-plastic range of the curve. Nemati et al. [22] developed a new methodology based on finite element techniques with a combination of several other methods to extend the component-based design philosophy to the cyclic behavior of the end plate connections. Also Kukreti et al. [23], and Bahaari and Sherbourne [24] have employed finite element methods to analyze end plate joints under monotonic loading.

The literature is filled with papers that use the finite element method to predict the behavior of different types of end plate connections under static loading conditions. This study is motivated by a lack of adequate numerical research concerning the performance of flush end plate moment connections subjected to cyclic loading. In the present study, the main focus is on developing a finite element model to investigate the cyclic performance of flush end plate connections. To achieve this purpose, first the analytical model is verified by comparing the numerical results with the

measured responses from the laboratory experiments conducted by Broderick and Thomson [3]. Next, the seismic performance of several different flush end plate connections is evaluated by subjecting the analytical models to cyclic and monotonic rotation. Then the accuracy of current design equations and philosophies under cyclic loading are examined. Afterwards, the influence of the thickness of the end plate and the diameter of the bolt on the behavior of these types of connections are investigated. Finally, the ability of this connection to act as rigid moment connection and form the plastic hinge in the connecting beam is examined.

II. FINITE ELEMENT MODEL

In this section the finite element model developed to analyze the flush end plate connection is discussed. The finite element analysis software package, ANSYS, is used to create a three-dimensional model of the connection including beam cross section, column cross section, end plate, bolts and different contact surfaces (between plate and column flange and between bolt head and nut and plate and column flange). The validation procedure for the numerical model is presented in the next section.

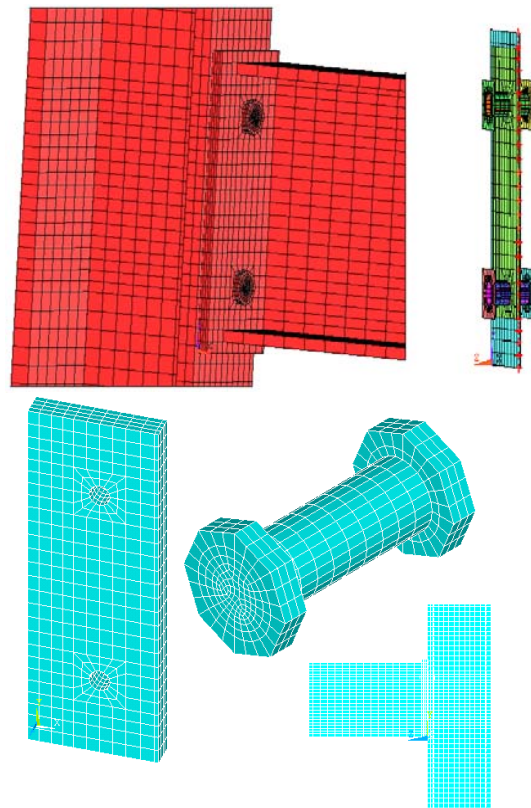

Fig. 2 Model of Flush end plate connection and meshing configuration

Solid elements have been employed in order to model the end-plate, beam, column, and bolts. This element is an eight-node element with three degrees of freedom in each node and

total of 24 degrees of freedom. The other element used in this model is the contact element. This element is employed in order to model the interaction between end-plate and column flange and also the interaction between bolts and end-plate and column flange. The accuracy of the contact coefficient is assessed via trial and error to best capture contact behavior (allowing little penetration in the contact surface). Convergence issues arise if the contact surface stiffness is too large and no penetration was permitted. Fig. 2 depicts the flush end plate joint and the location of contact elements.

A. Boundary Conditions

Employing symmetry of the joint, one-half of the joint is modeled to significantly reduce computation time. Boundary conditions in the finite element model are modeled to closely mimic specimen fixity in the Broderick and Thomson [3] experimental setup. The nodes located on the plane of symmetry of end plate are restrained against horizontal displacement. To simulate the actual test setup configuration, nodes located at the top and bottom section of column in the middle plate of the column web are restrained in all directions.

B. Material Properties

The nonlinear stress strain behavior of steel has been imposed on the model by introducing two different stress strain curves: one curve for bolts and another curve for the beam, column, and end plate materials. Figs. 3 (a) and (b) provide the detailed description for these curves. The yield stress (F_y) and the ultimate stress (F_u) used for beam, column, and endplate are respectively 240 MPa and 360 MPa. The yield stress (F_y) of 640 MPa and the ultimate stress (F_u) of 800 MPa, are considered for bolts in the analysis. Isotropic hardening is used as a material model for models analyzed under monotonic loading and kinematic hardening is used for cyclically loaded models.

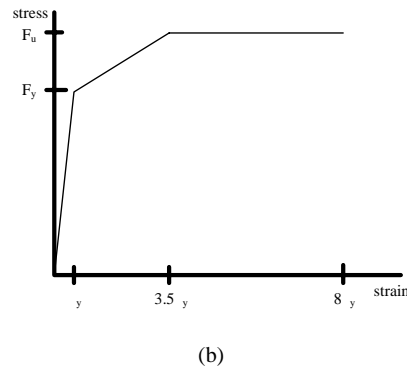
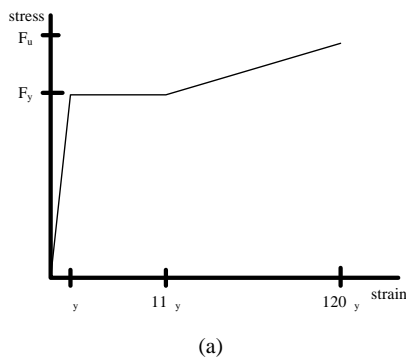

Fig. 3 Stress-strain curve: (a) for beam, column, and end plate, (b) for bolts

III. FEM RESULTS

Several specimens of flush end plate connections have been tested under monotonic and cyclic loading by Broderick and Thomson [3]. This work attempts to model and analyze four of these specimens (two subjected to monotonic loading and two subjected to cyclic loading) to validate the accuracy of the model. The characteristics of these specimens are shown in Table I. In Fig. 4 the details of end plate configuration are shown according to the experimental work.

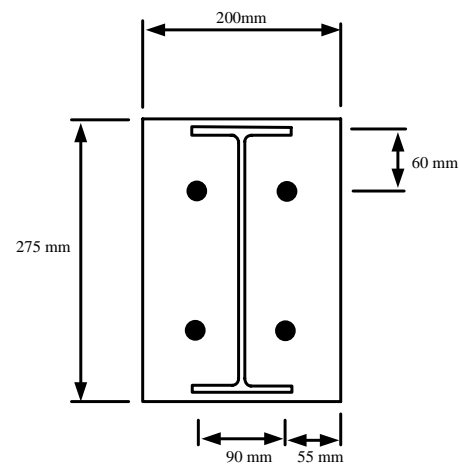

Fig. 4 End plate details

The moment rotation curves obtained from tests and from FEM analysis are compared in Figs. 5 to 8. To comply with the experimental program, cyclic loading is applied in accordance with ECCS [25]. Comparisons between experimental results and finite element analyses are promising: Table II summarizes these results. Also Table III shows the error percentage for each parameter. It is evident that FEM results are in agreement with test results.

TABLE I
SPECIMENS TESTED IN THE EXPERIMENTAL PROGRAM [3] AND MODELED FOR VERIFICATION

Specimen number	Beam section	Column section	End plate thickness (mm)	Bolt grade	Bolt diameter (mm)	Loading type
EP1	254x146x37 UB	203x203x86 UC	12	8.8	20	Monotonic
EP2	254x146x37 UB	203x203x86 UC	20	8.8	16	Monotonic
EP3	254x146x37 UB	203x203x86 UC	12	8.8	20	Cyclic
EP4	254x146x37 UB	203x203x86 UC	20	8.8	16	Cyclic

Section names are from the British Universal Columns and Beams
Bolt grade 8.8 denotes: $F_u=800$ Mpa, $F_y=640$ Mpa

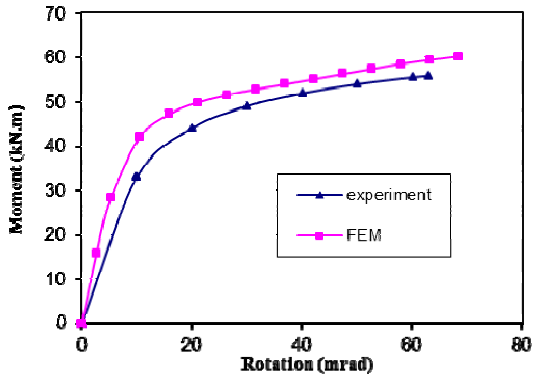

Fig. 5 Moment rotation for EP1

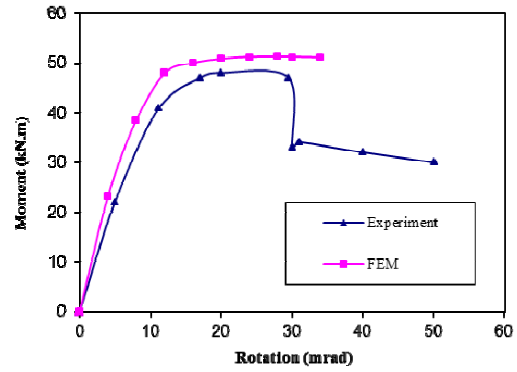
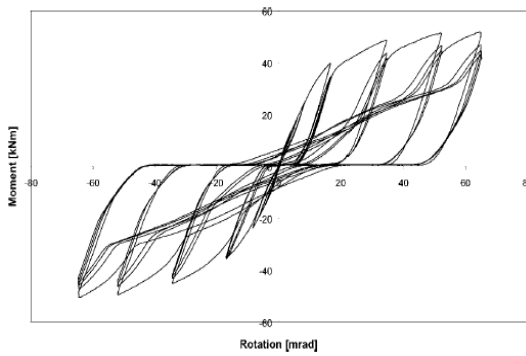
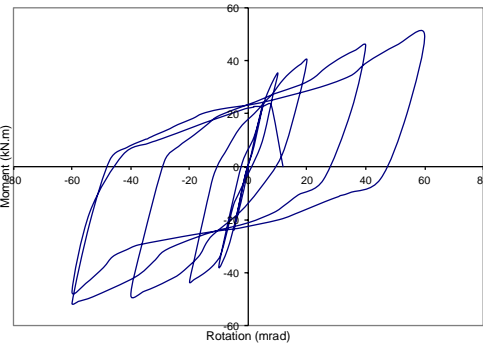

Fig. 6 Moment rotation for EP2



(a)



(b)

Fig. 7 Moment rotation for EP3: (a) Experimental [3], (b) FEM

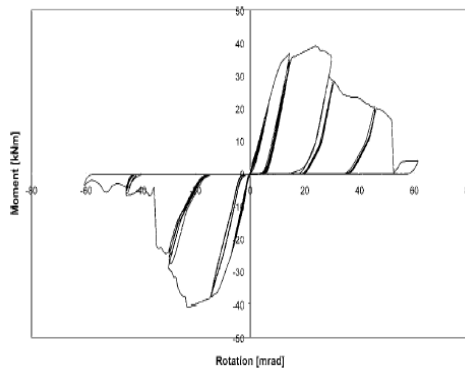

(a)

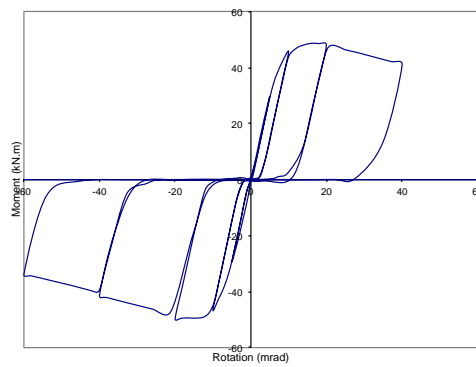

(b)

Fig. 8 Moment rotation for EP4: (a) Experimental [3], (b) FEM

TABLE II
MOMENT–ROTATION CHARACTERISTICS: EXPERIMENTAL VS. FEM

Specimen Number	EP1		EP2		EP3		EP4	
	FEM	Exp.	FEM	Exp.	FEM	Exp.	FEM	Exp.
Yield Rotation (mrad)	8.1	6.35	11	11.2	10	10.4	10	11
Yield moment (KN.m)	40.2	39.2	44	43	42	36.8	40.7	36.2
Ultimate Rotation (mrad)	65	62.8	34	28.3	60	65.2	22	23.8
Ultimate moment (KN.m)	60.2	55.8	51.1	47.3	53.3	51.9	44.8	39.9

TABLE III
PERCENTAGE ERROR OF FEM WITH RESPECT TO EXPERIMENTAL TESTS

Specimen Number.	Yield Rotation (mrad)	Yield Moment (kN.m)	Ultimate Rotation (mrad)	Ultimate Moment (kN.m)
EP1	27%	2.5%	3.5%	7.9%
EP2	2%	2.3%	20%	8%
EP3	3.8%	14%	8%	2.7%
EP4	9%	12%	7.5%	12%

IV. ANALYTICAL EQUATIONS BASED ON YIELD LINE THEORY AND SPLIT-TEE MODEL

Based on the yield line theory one can predict the end plate thickness (t_p) and connection strength (M_{pl}). The end plate thickness (t_p) and connection strength (M_{pl}) presented here for the flush end plate connection is taken from a study done by Srouji et al. [26]. For the configuration shown in Fig. 9, the following equations are obtained:

$$t_p = \left(\frac{M_u / F_{py}}{(h - p_t) \left(\frac{b_f}{2} \right) \left(\frac{1}{p_f} + \frac{1}{s} \right) + \frac{2}{g} (p_f + s)} \right)^{\frac{1}{2}} \quad (1)$$

$$M_{pl} = F_{py} t_p^2 (h - p_t) \left\{ \frac{b_f}{2} \left(\frac{1}{s} + \frac{1}{p_f} \right) + \frac{2}{g} (p_f + s) \right\} \quad (2)$$

in which h is the end plate height, b_f is the end-plate width, p_f is the bolt pitch, g is the bolt gage, p_t is the bolt edge distance, F_{py} is the yield strength of the end plate, M_u is the factored beam moment of the end-plate and s is the distance between parallel yield lines. All parameters in above equations are schematically depicted in Fig. 9.

Although the yield line theory is useful for predicting the strength of the end plate connection, it does not consider the forces that are carried into the bolts of the connection. Kennedy et al. [27] proposed a method that predicts bolt forces including the prying action which occurs in end plate connections. The basic assumption of this method is that the tension region of a moment end-plate connection is analogous to split-tee connections. Furthermore, the web of the beam is neglected in resisting the moment at the connection and the tension flange is assumed to behave as the web of the tee section resisting against the moment. The details of this method are presented in [27].

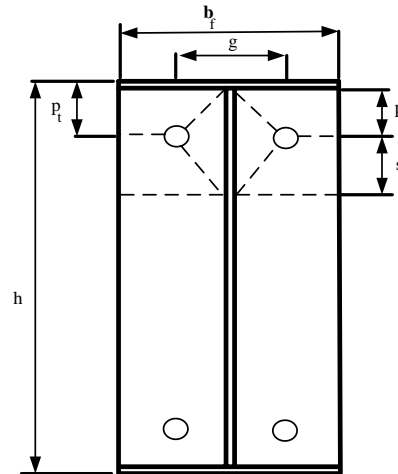

Fig. 9 Yield Line pattern for flush end plate connection

Table IV presents eight new connections designed based on the yield line theory and Kennedy method. These connections are modeled and analyzed using finite element method. Table IV provides end plate thickness, bolt diameter, and bolt yield stress as well as ultimate moment capacity of the end plate predicted according to the design equations of yield line theory, and the moment capacity predicted according to bolt forces derived from Kennedy method.

The accuracy of these equations when the connection is subjected to cyclic loading has been investigated. The ultimate moment derived from design equations is compared to the moment capacity obtained from the cyclic loading analysis of the connection using FEM (Table V). Fig. 10 illustrates this comparison; the hysteresis curves from finite element analysis for specimens EPN1 to EPN8 are compared to the moment capacity of the corresponding specimen derived from the design equations. This comparison shows that the design equations predict the capacity of the flush end plate joints relatively well in cases EPN1, 4, 6, and 8. In case EPN2 the design equation is very conservative and in cases EPN3, 5, and 7 the design approach is very unconservative and needs further attention.

V. EFFECT OF ENDPLATE THICKNESS ON THE BEHAVIOR OF THE CONNECTION

One of the most effective parameters on the behavior of flush endplate connections is the endplate thickness. The effect of this parameter is investigated by using three different values, while other parameters of the connection are held constant. To be practical, the end plate thicknesses selected are 12, 16, and 20 mm corresponding to specimens EPN1, EPN8, and EPN6 respectively. The Von Mises stress contour plots for these three specimens are presented in Fig. 11. It is apparent that endplate thickness affects the behavior of flush end plate significantly, and when it increases, the workability and deformability of this connection improves notably. We can observe on the Von Mises stress contour that when the

end plate thickness increases, the plastic hinge moves away from connection and goes towards the connecting beam. This is very desirable in seismic design where the formation of the plastic hinges at the location of connection and its vicinity must be avoided.

TABLE IV
SPECIMENS' PARAMETERS AND PREDICTED VALUES BY DESIGN EQUATIONS

Number	End plate Thickness t_p (mm)	Bolt diameter d_p (mm)	Bolt Yield Strength F_{by} (MPa)	Moment Capacity of End Plate M_p (KN.m)	Moment Capacity of Bolts M_B (KN.m)
EPN1	12	20	640	45	70
EPN2	12	20	900	45	103
EPN3	12	25	640	45	78
EPN4	20	16	900	126	78
EPN5	20	25	640	126	116
EPN6	20	20	640	126	79
EPN7	20	20	900	126	119
EPN8	16	20	640	81	74

TABLE V
COMPARISON BETWEEN DESIGN EQUATIONS AND FEM ANALYSIS

Number	FEM Ultimate Moment M_u (KN.m)	Predicted Moment Capacity From Design Equations M_d (KN.m)	Moment Ratio Design/FEM
EPN1	50	45	0.90
EPN2	69	45	0.65
EPN3	75	45	0.60
EPN4	79	78	0.99
EPN5	98	116	1.18
EPN6	83	79	0.96
EPN7	105	119	1.13
EPN8	81	74	0.92

VI. EFFECT OF BOLT DIAMETER ON THE BEHAVIOR OF THE CONNECTION

Another effective parameter on the behavior of flush endplate connections is the bolt diameter. This parameter becomes even more effective and critical when the flush end plate connection is sparsely bolted. In this research this parameter is investigated by using three different sizes, while other parameters of the connection are held constant. The selected bolt sizes are 16, 20, and 25mm which respectively correspond to specimens EP4, EPN6, and EPN5. As it can be observed from the hysteresis curves corresponding to these specimens (Fig. 8 for EP4 and Fig. 10 for EPN5 and EPN6), the connection with 16mm bolt diameter has a smaller ultimate moment and ultimate rotation. When the bolt diameter increases the strength of the connection increases substantially, and consequently the ability of connection to absorb energy increases. It is also observed in the stress contour plots (Fig. 12) that when the bolt diameter increases the plastic hinge forms in the connecting beam and not in the

connection. Figs. 12 (a) and (c) depict two different failure modes. In the former, the connection fails when the beam is still within its elastic range. In the latter, a plastic hinge forms in the beam at failure. This plastic hinge formation, as mentioned previously, is desirable in seismic design.

VII. SUMMARY AND CONCLUSION

The primary objective of this research was to develop a finite element model for the flush endplate connection that evaluates the seismic behavior of the connection. A three dimensional model of the flush end plate connection was developed in the finite element analysis software, ANSYS, and the results were discussed. The finite element model was verified by experimental results. This research also assessed the accuracy of the design equations of flush end plate connections. In this direction, the yield moment capacity of flush end plate connection attained by finite element analysis under cyclic loading was compared by the results obtained from design equations based on yield line theory and the Kennedy method. Finally, end plate thickness and bolt diameter were determined to be most influential in the performance of these connections, especially under seismic loading.

After analyzing several flush end plate connections with the varying cases of bolt diameters and end plate thicknesses, the following conclusions are presented:

- An analytical model such as finite element model could be an ideal solution for analyzing flush end plate connections. This research demonstrates that the finite element model introduced was useful in analyzing flush end plate joints and it could be employed to predict the behavior of this joints accurately even under cyclic loading.
- Design equations for the prediction of moment capacity in the flush end plate moment connections are not accurate in all cases and should be used with care.
- The moment capacity and stiffness of the flush end plate connection increase with thicker endplates. However, increases in the endplate thickness did not result in an increase in connection ductility.
- The behavior of flush end plate connection was strongly dependent on the diameter of the bolts. Incorrect selection of bolts could result in brittle fracture in connections due to the fracture of the bolts not due to the yielding of the end plate. Therefore the bolts must be able to carry the moment capacity of end plate, at a minimum.
- Endplate thickness and bolt diameter are two effective parameters in characterizing the behavior of flush end plate connections. If they are appropriately chosen, plastic hinge formation in the connecting beam may be enforced; this is very desirable in seismic design.

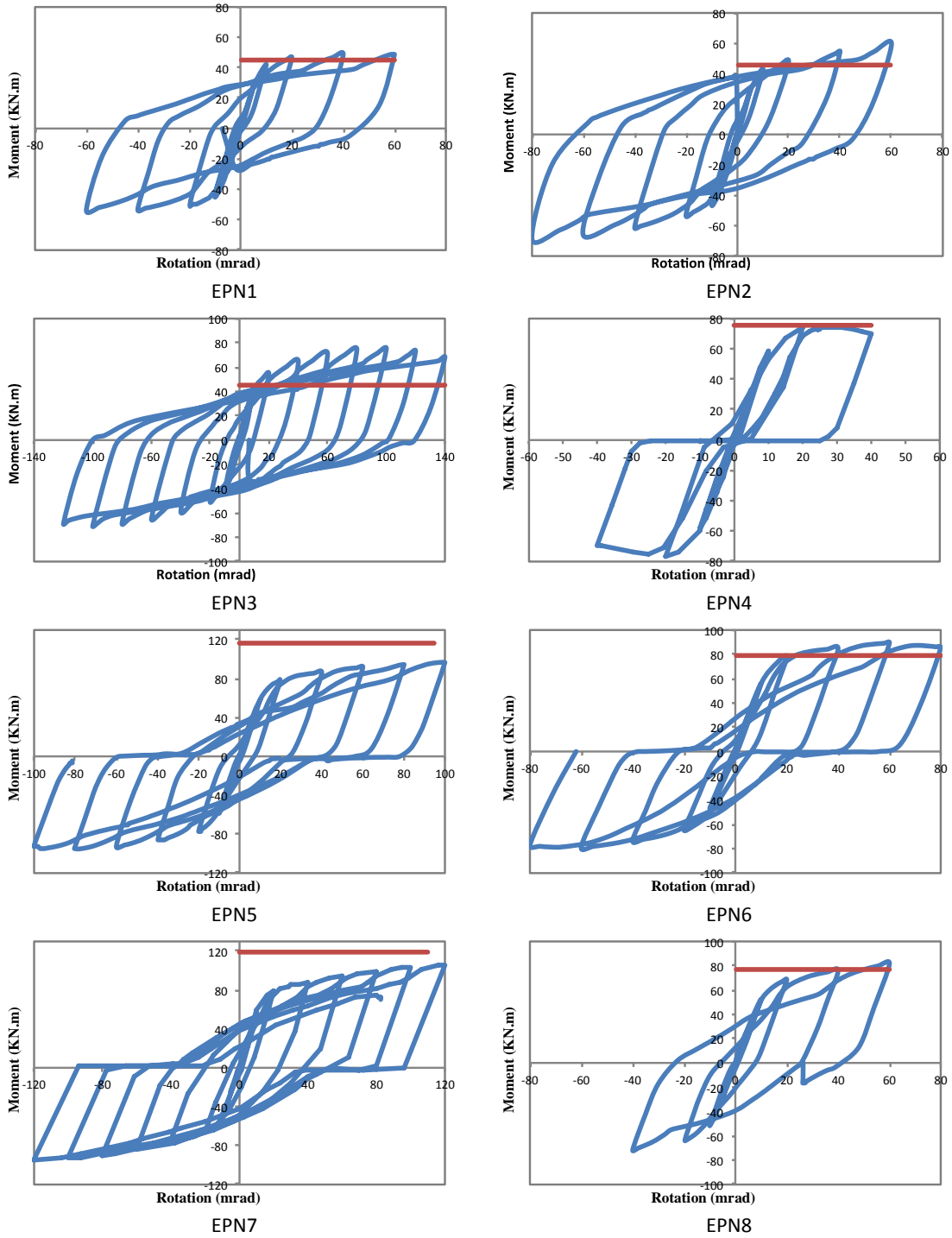
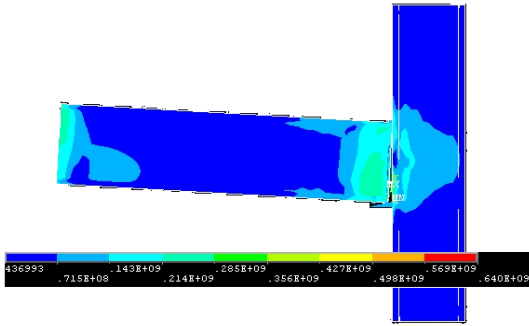
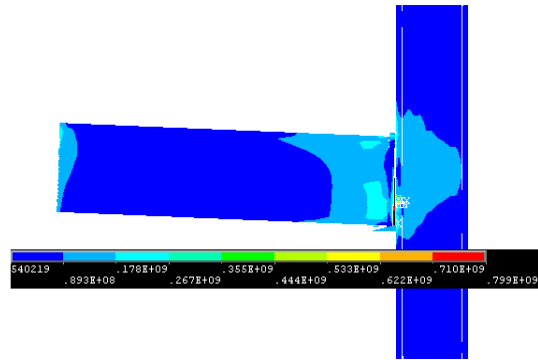

Fig. 10 Moment rotation curve for all specimens



(a) $t_p=12$ mm



(a) $d_b= 16$ mm

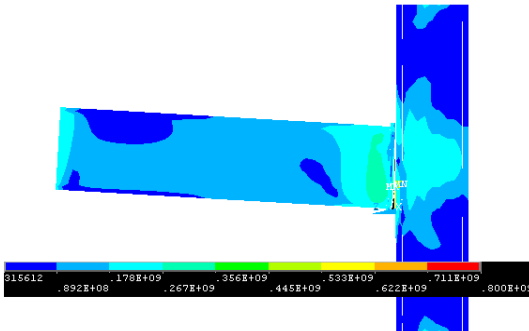

(b) $t_p=16$ mm

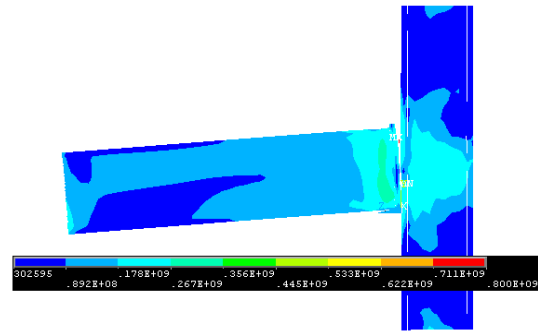

(b) $d_b= 20$ mm

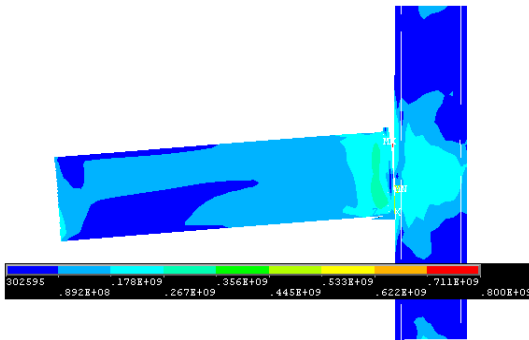

(c) $t_p= 20$ mm

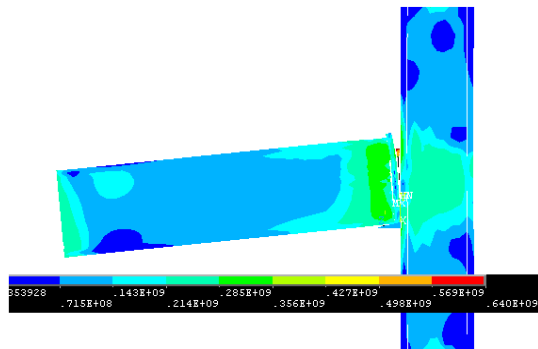

(c) $d_b= 25$ mm

Fig. 11 Von Mises stress contours for (a) 12mm-thick-plate connection (b) 16mm-thick-plate connection (c) 20 mm-thick-plate connection

Fig. 12 Von Mises stress contours for (a) 16mm-bolt connection (b) 20mm-bolt connection (c) 25mm-bolt connection

REFERENCES

- [1] K. Lee and D. Foutch, "Seismic Performance Evaluation of Pre-Northridge Steel Frame Buildings with Brittle Connections," *Journal of Structural Engineering*, vol. 128, no. 4, pp. 546–555, 2002.
- [2] J. T. Borgsmiller and T. M. Murray, "Simplified Method for Design of Moment End Plate Connections," Virginia Polytechnic Institute and State University, Blacksburg, Virginia, Report No. CE/VPI-ST 95/19, 1995.
- [3] B. M. M. Broderick and a. W. W. Thomson, "The Response of Flush End-Plate Joints under Earthquake Loading," *Journal of Constructional Steel Research*, vol. 58, no. 9, pp. 1161–1175, Sep. 2002.
- [4] J. Phillips and J. A. Packer, "The Effect of Plate Thickness on Flush End-Plate Connections," in *International Conference on Joints in Structural Steel Work*, 1981, pp. 6.77–6.92.
- [5] G. Shi, Y. Shi, and Y. Wang, "Behaviour of End-Plate Moment Connections under Earthquake Loading," *Engineering Structures*, vol. 29, no. 5, pp. 703–716, 2007.
- [6] G. Shi, Y. Shi, Y. Wang, and F. Bijlaard, "Monotonic Loading Tests on Semi-Rigid End-Plate Connections with Welded I-Shaped Columns and Beams," *Advances in Structural Engineering*, vol. 13, no. 2, pp. 215–229, 2010.
- [7] W.-L. Shi, G.-Q. Li, Z.-M. Ye, and R. Y. Xiao, "Hysteretic Models for Composite Joints with Flush End Plate Connections Based On Experimental Investigation," in *5th International Conference on Advances in Steel Structures, ICASS*, Dec. 5 - Dec. 7, 2007, vol. 3, pp. 849–854.
- [8] H. Yu, I. W. Burgess, J. B. Davison, and R. J. Plank, "Experimental and Numerical Investigations of the Behavior of Flush End Plate Connections at Elevated Temperatures," *Journal of Structural Engineering*, vol. 137, no. 1, pp. 80–87, 2011.
- [9] A. Abidelah, A. Bouchair, and D. E. Kerdal, "Experimental and Analytical Behavior of Bolted End-Plate Connections with or without Stiffeners," *Journal of Constructional Steel Research*, vol. 76, pp. 13–27, 2012.
- [10] A. Abolmaali, A. R. Kukreti, and H. Razavi, "Hysteresis Behavior of Semi-Rigid Double Web Angle Steel Connections," *Journal of Constructional Steel Research*, vol. 59, no. 8, pp. 1057–1082, Aug. 2003.
- [11] A. K. Aggarwal, "Behaviour of Flush End Plate Beam-to-Column Connections," *Journal of the Institution of Engineers (India)*, Part CV: Civil Engineering Division, vol. 73, no. 1, p. 12, 1992.
- [12] A. K. Aggarwal, "Comparative Tests on Endplate Beam-to-Column Connections," *Journal of Constructional Steel Research*, vol. 30, no. 2, pp. 151–175, Jan. 1994.
- [13] D. M. Hendrick, T. M. Murray, and A. R. Kukreti, "Unification of Flush End-Plate Design Procedures," University of Oklahoma, Norman, Oklahoma, Report No. FSEL/MBMA 8305, 1985.
- [14] A. W. Thomson and B. M. Broderick, "Earthquake Resistance of Flush End-Plate Steel Joints for Moment Frames," *Proceedings of the Institution of Civil Engineers: Structures and Buildings*, vol. 152, no. 2, pp. 157–165, 2002.
- [15] A. Abolmaali, A. A. R. Kukreti, and T. M. Murray, "Finite Element Analysis of Two Tension Bolt Flush End-plate Connection," Research Report No. FSEL/MBMA 84-01, School of Civil Engineering and Environmental Science, University of Oklahoma, 1984.
- [16] A. Abolmaali, J. H. Matthys, M. Farooqi, and Y. Choi, "Development of Moment-Rotation Model Equations for Flush End-Plate Connections," *Journal of Constructional Steel Research*, vol. 61, no. 12, pp. 1595–1612, 2005.
- [17] K. S. Al Jabri, "Numerical Modelling of the Behaviour of Flush End-Plate Bare-Steel Connections at Elevated Temperature BT," in *First International Conference on High Performance Structures and Composites*, Mar. 11 - Mar. 13., 2002, vol. 4, pp. 387–396.
- [18] B. Bose, Z. M. Wang, and S. Sarkar, "Finite-Element Analysis of Unstiffened Flush End-Plate Bolted Joints," *Journal of Structural Engineering*, vol. 123, no. 12, pp. 1614–1621, Dec. 1997.
- [19] N. Krishnamurthy, "A Fresh Look at Bolted End- Plate Behavior and Design," *Engineering Journal, AISC*, vol. 15, no. 2, pp. 39–49, 1978.
- [20] A. R. Kukreti, T. M. Murray, and A. Abolmaali, "End-Plate Connection Moment-Rotation Relationship," *Journal of Constructional Steel Research*, vol. 8, pp. 137–157, 1987.
- [21] M. Md Tahir, I. Juki, L. H. Yong, S. Mohammad, and S. P. Ngian, "Finite Element Analysis of Flush End-Plate Connections Connected to Column Web," *International Journal of Steel Structures*, vol. 11, no. 3, pp. 247–258, 2011.
- [22] N. Nemati, D. Le Houedec, and R. Zandonini, "Numerical Modelling of the Cyclic Behaviour of the Basic Components of Steel End Plate Connections," *Advances in Engineering Software*, vol. 31, no. 11, pp. 837–849, 2000.
- [23] A. R. Kukreti, M. Ghassemieh, and T. M. Murray, "Behavior and Design of Large-Capacity Moment End Plates," *Journal of Structural Engineering New York, N.Y.*, vol. 116, no. 3, pp. 809–828, 1990.
- [24] M. R. Bahaari and A. N. Sherbourne, "Computer Modelling of an Extended End-Plate Bolted Connection," *Computers and Structures*, vol. 52, no. 5, pp. 879–893, 1994.
- [25] European Convention for Constructional Steelwork (ECCS), "Recommendation Testing Procedure for Assessing the Behavior of Structural Steel Elements under Cyclic Loading. In: Technical Committee 1: Structural Safety and Loading."
- [26] R. Srouji, A. R. Kukreti, and T. M. Murray, "Yield-Line Analysis of End-plate Connections with Bolt Force Predictions," Report #: FSEL/MBMA 83-05. Fears Structural Engineering Laboratory, School of Civil Engineering and Environmental Science, University of Oklahoma, 1983.
- [27] N. A. Kennedy, S. Vinnakota, and A. N. Sherbourne, "The Split-Tee Analogy in Bolted Splices and Beam-Column Connections," in *Proceedings of the International Conference on Joints in Structural Steelwork*, 1981, pp. 2.138–2.157.