

Exact Analysis of Resonance Frequencies of Simply Supported Cylindrical Shells

A. Farshidianfar, P. Oliazadeh, M. H. Farshidianfar

Abstract—In order to study the free vibration of simply supported circular cylindrical shells; an analytical procedure is developed and discussed in detail. To identify its' validity, the exact technique was applied to four different shell theories 1) Soedel, 2) Flugge, 3) Morley-Koiter, and 4) Donnell. The exact procedure was compared favorably with experimental results and those obtained using the numerical finite element method. A literature review reveals that beam functions are used extensively as an approximation for simply supported boundary conditions. The effects of this approximate method were also investigated on the natural frequencies by comparing results with those of the exact analysis.

Keywords—Circular Cylindrical Shell, Free Vibration, Natural Frequency.

I. INTRODUCTION

SIMILAR to beams and plates, in many branches of engineering, cylindrical shells are the practical elements of various engineering structures such as pipes and ducts, bodies of cars, space shuttles, aircraft fuselages, ship hulls, submarines and construction buildings. However, analyzing the dynamic characteristics of cylindrical shells is more complicated than that of beams and plates. This is mainly because; the equations of motion of cylindrical shells combined with boundary conditions are more complex.

A comprehensive summary and discussion of shell theories including natural frequencies and mode shape information has been done by Liessa [1] in 1973. More recently, Amabili and Paidoussis [2], Amabili [3], and Kurylov and Amabili [4] have presented noteworthy reviews with a non-linear point of view. Many investigations followed the pioneering work of Love [5] using his first approximation theory, such as Flugge [6]. The Flugge theory is based on Kirchhoff-Love hypothesis for thin elastic shells. By using this theory, the strain-displacement relations and changes of curvatures of the middle surface of a cylindrical shell can be obtained. The simplified Donnell's theory would be achieved by neglecting few terms in Flugge equations

Livanov [7] applied love's assumption and used displacement functions to solve the problem of axisymmetrical vibrations of simply supported cylindrical shells. Rinehart and Wang [8] investigated the vibration of simply supported cylindrical shells stiffened by discrete longitudinal stiffeners

using Donnell's approximate theory, Flugge's more exact theory and Love's assumption for longitudinal wave numbers. These theories are not only concerned with simply supported end conditions, but they have also applied other boundaries, such as cantilever cylindrical shells [9], fixed free circular cylindrical shells [10], clamped-clamped shells [11] and infinite length shells [12]. Most researchers and those cited above, use beam function as an approximation for the simply supported boundary conditions and find natural frequencies of vibration by the approximate method. This approximation is also useful for finite element analysis of cylindrical shells by using Hermitain polynomial of beam function type [13]. In addition to the approximate method, there are other approaches to find natural frequencies, like the computer based numerical method [14], [15] to avoid cumbersome computational effort and the wave propagation technique [16]. More recently Farshidianfar et al. [17] used the advantage of acoustical excitation to find natural frequency of long cylindrical shells.

In the present study, an exact analytical approach is proposed to investigate the free vibration of simply supported cylindrical shells. As cited above, in traditional analysis, beam functions with similar boundary conditions are used to approximate wave numbers in the axial direction. This method is considered as an approximate technique. The exact method is used to obtain the natural frequencies based on four different shell theories (Soedel, Flugge, Morley-Koiter and Donnell) and compared with the approximate method. Finally the results are compared with experimental and numerical results and show good agreement.

II. THEORETICAL ANALYSIS

The cylindrical shell under consideration is with constant thickness h , mean radius R , axial length L , Poisson's ratio ν , density ρ and Young's modulus of elasticity E . Here the respective displacements in the axial, circumferential and radial directions are denoted by $u(x, \theta, t)$, $v(x, \theta, t)$ and $w(x, \theta, t)$, and as shown in Fig. 1.

A. Farshidianfar is with mechanical engineering department, Ferdowsi University of Mashhad, Iran (phone: +98-511-8763304; fax: +98-511-8763304; e-mail: farshid@ferdowsi.um.ac.ir).

P. Oliazadeh and M. H. Farshidianfar are with mechanical engineering department, Ferdowsi University of Mashhad, Iran (e-mail: pouria.oliazadeh@gmail.com, mohfarshid@gmail.com).

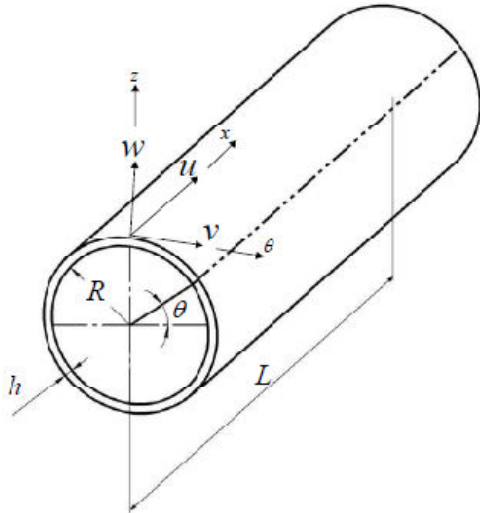

Fig. 1 Circular cylindrical shell: coordinate system and dimensions

In order to study free vibration of a cylindrical shell, the equations of motion can be written in matrix form as follows:

$$\begin{bmatrix} L_{11} & L_{12} & L_{13} \\ L_{12} & L_{22} & L_{23} \\ -L_{13} & -L_{23} & L_{33} \end{bmatrix} \begin{Bmatrix} u(x, \theta, t) \\ v(x, \theta, t) \\ w(x, \theta, t) \end{Bmatrix} = \begin{Bmatrix} 0 \\ 0 \\ 0 \end{Bmatrix} \quad (1)$$

where L_{ij} ($i, j = 1, 2, 3$) are differential operators with respect to x , θ and t .

Different systems of equations are used to model the vibration behavior of circular cylindrical shells. In this paper four of the most common theories namely: 1) Soedel [18], 2) Flugge [6], 3) Morley-Koiter [19], and 4) Donnell's theory [3], are used to find natural frequencies.

The first attempt in solving (1) is the assumption of a synchronous motion:

$$\begin{cases} u(x, \theta, t) = U(x, \theta) f(t) \\ v(x, \theta, t) = V(x, \theta) f(t) \\ w(x, \theta, t) = W(x, \theta) f(t) \end{cases} \quad (2)$$

where $f(t)$ is the scalar modal coordinate corresponding to the mode shapes $U(x, \theta)$, $V(x, \theta)$ and $W(x, \theta)$.

The next step is to use the separation of variables method in order to separate the spatial dependence of the modal shape between longitudinal and circumferential directions. Hence the axial, tangential and radial displacements of the wall vary according to:

$$\begin{cases} u(x, \theta, t) = A e^{\lambda_m x} \sin(n\theta) \cos(\omega t) \\ v(x, \theta, t) = B e^{\lambda_m x} \cos(n\theta) \cos(\omega t) \\ w(x, \theta, t) = C e^{\lambda_m x} \sin(n\theta) \cos(\omega t) \end{cases} \quad (3)$$

in which λ_m and n are the axial wavenumber and the circumferential wave parameter, respectively. A, B and C are the undetermined constants, and ω is the circular frequency of the natural vibration.

Substituting (3) into (1), using any of the shell theories, leads to a set of homogenous equations having the following matrix form:

$$\begin{bmatrix} C_{11} & C_{12} & C_{13} \\ -C_{12} & C_{22} & C_{23} \\ -C_{13} & C_{23} & C_{33} \end{bmatrix} \begin{Bmatrix} A \\ B \\ C \end{Bmatrix} = \begin{Bmatrix} 0 \\ 0 \\ 0 \end{Bmatrix} \quad (4)$$

in which $[C_{ij}]$ ($i, j = 1, 2, 3$) are functions of n, λ_m and a frequency parameter Ω that is defined as follows:

$$\Omega^2 = \frac{(1-\nu^2)\rho}{E} \omega^2 R^2. \quad (5)$$

As an example, for Donnell theory $[C_{ij}]$ can be written in matrix form as in (4).

$$\begin{bmatrix} \Omega^2 + \lambda_m^2 - \frac{1-\nu}{2} n^2 & -\frac{1+\nu}{2} n \lambda_m & \nu \lambda_m \\ \frac{1+\nu}{2} n \lambda_m & \Omega^2 + \frac{1-\nu}{2} \lambda_m^2 - n^2 & n \\ -\nu \lambda_m & n & \Omega^2 - [1 + k(\lambda_m^2 - n^2)^2] \end{bmatrix} \begin{Bmatrix} A \\ B \\ C \end{Bmatrix} = \begin{Bmatrix} 0 \\ 0 \\ 0 \end{Bmatrix} \quad (6)$$

For nontrivial solution the determinant of the coefficient matrix in (4) must be zero:

$$\det([C_{ij}]) = 0; \quad i, j = 1, 2, 3. \quad (7)$$

The expansion of (7) will give the following two eigenvalue problems:

- For a given value of there exists one or more proper values for so that the (7) vanishes.
- For a given value of there exists one or more proper values for so that the (7) vanishes.

Solving (7) leads to a cubic equation in terms of the nondimensional frequency parameter Ω^2 . Thus for a fixed value m of and n , three positive roots and three negative roots are yield for the nondimensional frequency. The three positive roots are the natural frequencies of the cylindrical shell that can be classified as primarily axial, circumferential or radial. The lowest frequency is usually associated with a motion that is primarily radial (or flexural).

III. THE APPROXIMATE BEAM FUNCTION METHOD

In general, solving the roots of the characteristic equation of (7) for λ_m is not possible in closed form. Hence, researchers have often leaned to use approximate techniques. According to previous studies, beam functions have already been widely used to obtain natural frequencies and approximate displacements for closed circular cylindrical shells. According to the approximate method, for a simply supported shell at both ends, the nature of the axial mode can be defined as:

$$\lambda_m = m\pi \frac{R}{L} \sqrt{-1} \quad (8)$$

By substituting (8) into (7), the only unknown of the characteristic equation will be the frequency parameter Ω^2 for a fixed combination of m and n .

However, this approach is straightforward; in fact it is an approximation for boundary condition of a simply supported circular cylindrical shell. However, since cylindrical shell vibration is totally different compared to beams of the same type, it is important to check the accuracy of this approximation.

Thus, the exact analytical technique that uses the boundary condition equations is proposed and the results of both the approximate and exact method are compared with the experimental and numerical ones.

IV. THE EXACT METHOD

In this section an exact analysis is presented, which could be applied to any theory discussed.

At each end of the cylindrical shell, four boundary conditions must be specified. For the simply supported shell the following boundary conditions are imposed:

$$w = 0, \quad v = 0, \quad M_x = 0, \quad N_x = 0 \quad \text{at } x = 0, L. \quad (9)$$

These conditions restraining the v and w components of shell displacements at their mutual boundaries and they would cause negligible internal bending moment M_x and membrane normal force N_x , in the shell as the shell deforms. By using the approach mentioned in [3], and eliminating nonlinear terms, the simply supported boundary conditions for various shell theories are obtained as follows:

Soedel

$$M_x = -\frac{Eh^3}{12(1-\nu^2)} \left\{ \frac{\partial^2 w}{\partial x^2} + \frac{\nu}{R^2} \left(\frac{\partial^2 w}{\partial \theta^2} - \frac{\partial v}{\partial \theta} \right) \right\} \quad (10)$$

$$N_x = \frac{Eh}{1-\nu^2} \left\{ \frac{\partial u}{\partial x} + \frac{\nu}{R} \left(\frac{\partial v}{\partial \theta} + w \right) \right\}$$

Flügge

$$M_x = -\frac{Eh^3}{12(1-\nu^2)} \left\{ \frac{\partial^2 w}{\partial x^2} + \frac{\nu}{R^2} \left(\frac{\partial^2 w}{\partial \theta^2} - \frac{\partial v}{\partial \theta} \right) - \frac{1}{R} \frac{\partial u}{\partial x} \right\} \quad (11)$$

$$N_x = \frac{Eh}{1-\nu^2} \left\{ \frac{\partial u}{\partial x} + \frac{\nu}{R} \left(\frac{\partial v}{\partial \theta} + w \right) - kR \frac{\partial^2 w}{\partial x^2} \right\}$$

Morley-Koiter

$$M_x = -\frac{Eh^3}{12(1-\nu^2)} \left\{ \frac{\partial^2 w}{\partial x^2} + \frac{\nu}{R^2} \frac{\partial^2 w}{\partial \theta^2} + \frac{1-\nu}{R^2} \frac{\partial v}{\partial \theta} + \frac{w}{R^2} \right\} \quad (12)$$

$$N_x = \frac{Eh}{1-\nu^2} \left\{ \frac{\partial u}{\partial x} + \frac{\nu}{R} \left(\frac{\partial v}{\partial \theta} + w \right) - k \frac{1-\nu}{R} \frac{\partial^2 w}{\partial \theta^2} \right\}$$

Donnell

$$M_x = -\frac{Eh^3}{12(1-\nu^2)} \left\{ \frac{\partial^2 w}{\partial x^2} + \frac{\nu}{R^2} \frac{\partial^2 w}{\partial \theta^2} \right\} \quad (13)$$

$$N_x = \frac{Eh}{1-\nu^2} \left\{ \frac{\partial u}{\partial x} + \frac{\nu}{R} \left(\frac{\partial v}{\partial \theta} - w \right) \right\}$$

Substituting the modal displacements into these constraints lead to a set of eight homogenous equations, expressed as follows:

$$[\mathbf{H}]_{8 \times 8} \{\mathbf{b}\}_{8 \times 1} = \{0\} \quad (14)$$

in which ω , λ_m and are the ten unknowns. For a nontrivial solution of (14) one requires:

$$\det[\mathbf{H}] = 0 \quad (15)$$

The driving frequencies are obtained by simultaneously solving both the characteristic equations for the 3×3 displacement coefficient matrix, (7) and the 8×8 boundary condition determinant, (15).

V. VALIDATION OF THE EXACT ANALYSIS

A Matlab program was written in order to obtain the resonance frequencies of a shell, using the exact method described in the section IV.

First, exact resonance frequencies were obtained based on the Soedel theory. Consider a cylindrical shell with dimensions; $\frac{L}{R} = 3$, $\frac{h}{R} = \frac{1}{20}$ and $\nu = \frac{1}{3}$. In order to yield the exact frequencies one has to solve (15) in terms of the non-dimensional frequency parameter, Ω . In Figs. 2-6 the determinant of the boundary coefficient matrix, (15) is calculated for constant values of circumferential wave parameter ($n=1,3,5,7$ and 9). As pointed out in section IV, in order to obtain a nontrivial solution the boundary coefficient determinant should equal to zero at the resonance frequency, Ω . However, as it can be seen by Figs. 2-6, none of the determinants reach zero. This is completely explainable considering the sensitiveness of (15) with respect to Ω . To

obtain the determinant of the boundary coefficient matrix in Figs. 2-6, a frequency sweep was carried out using steps of $\Delta\Omega=0.001$. On the other hand, (15) is very sensitive to frequency variations. Thus, the determinants represented in Figs. 2-6 should actually equal to zero, however, since frequency steps are not that much small they may not make the determinant exactly zero. Although in Figs. 2-6 at no frequency the determinants equal to zero, but, several minimum points are observed. These minimum points are actually the resonance frequencies of the shell at which the determinants are zero. However, as discussed in section IV, in order to be the resonance frequency of the system, the minimum points should also satisfy (7). Thus, in Figs. 2-6 the unmarked minimum points before $m=7$ are not a resonance frequency.

Accordingly, at higher frequencies higher axial wave parameters (m) occur. Figs. 2-6 are graphical representations of how the exact resonance frequencies are obtained using the method described in this paper. According to the exact method, each minimum point in the diagrams represents a mode shape and its resonance frequency. For better understanding, resonance frequencies corresponding to each mode shape in Figs. 2-6 are presented numerically in Table II.

Next, let us investigate the accuracy of using beam functions as an alternative to the exact method. In order to study such an approximation, natural frequencies were calculated using two methods; 1) the approximate method (in which $\lambda_m = m\pi \frac{R}{L} \sqrt{-1}$) and 2) the exact method (15). A comparison of the values of the non-dimensional frequency parameter, Ω , for a free vibrating circular cylindrical shell with the simply supported boundary conditions are shown through Tables I-VIII. Four diverse theories have been applied to compare their accuracy. All non-dimensional frequencies are calculated up to the fourth digit. As it can be seen, the approximate beam function analysis yields close results with the least errors. In Tables I-VIII mode shapes at which the approximate method obtains errors are marked by a (*) sign.

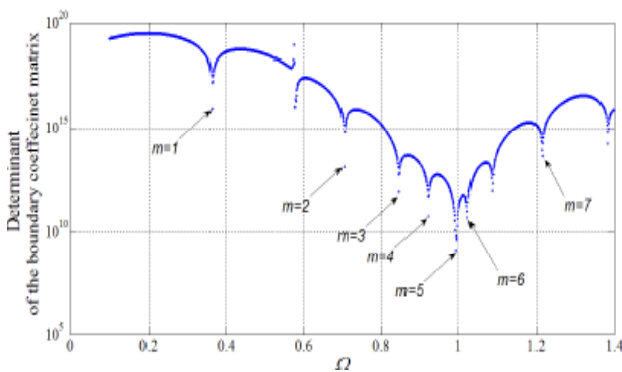

Fig. 2 Determinant of the boundary coefficient matrix versus frequency parameter for $n=1$

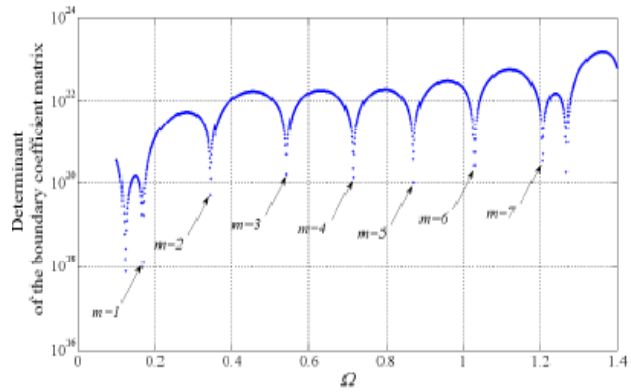

Fig. 3 Determinant of the boundary coefficient matrix versus frequency parameter for $n=3$

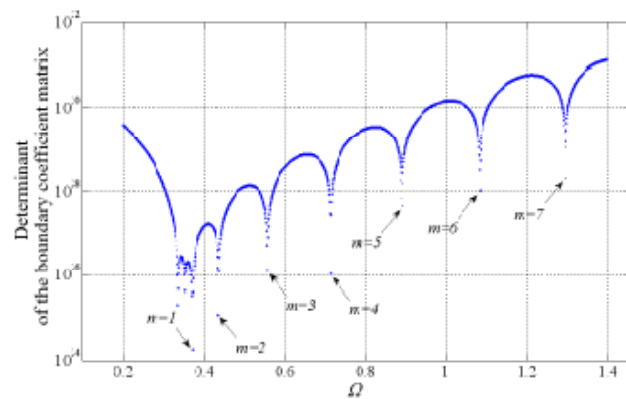

Fig. 4 Determinant of the boundary coefficient matrix versus frequency parameter for $n=5$

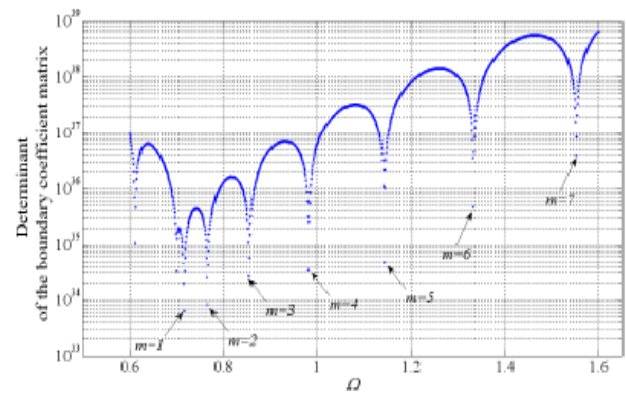

Fig. 5 Determinant of the boundary coefficient matrix versus frequency parameter for $n=7$

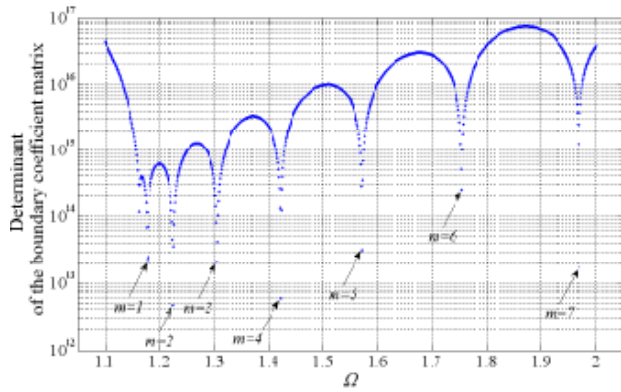

Fig. 6 Determinant of the boundary coefficient matrix versus frequency parameter for n=9

As one can see from the comparisons of Tables I-VIII, there are some minute discrepancies, which can be classified into two groups for all theories. First, those that happen for the $m=1$ modes, and second, the differences related to the $m \geq 2$ modes. In $m=1$ modes, the values of the errors are between 0.2-0.7 percent. However, for the $m \geq 2$ modes, the errors are between 0.001-0.01 percent, which is mainly a rounding error to the fourth digit. Moreover, according to Tables I-VIII, as the axial wave parameter m increases, the number of resonance frequencies containing an error decrease. Hence, the approximation method is similar to the exact analysis for $m \geq 2$ modes and for low mode numbers of $m=1$ and $5 \leq n$.

On the hand, for low mode numbers of $m=1$ and $1 \leq n \leq 4$, the approximate method is not that accurate. Therefore, the exact method is found to be more accurate for low mode numbers. Thus, the approximate method is only recommended to be used for high mode numbers and high resonance frequencies.

Furthermore, comparing different theories in Tables I-VIII, it is noticeable that the approximate Soedel theory is the most accurate amongst all theories analyzed. On the other hand, the approximate Morley-Koiter theory yields the most errors. However, as explained above, as the frequency and mode numbers increase, the errors of the approximation decrease for all theories.

TABLE I
FREQUENCY PARAMETER FOR THE SOEDEL'S SHELL THEORY BY THE APPROXIMATION METHOD WITH $\frac{L}{R} = 3, \frac{h}{R} = \frac{1}{20}, \nu = \frac{1}{3}$

n	m=1	m=2	m=3	m=4	m=5	m=6	m=7
1	0.3672	0.7045	0.8473	0.9213	0.9924	1.0859	1.2142
2	0.1867	0.4647	0.6695	0.8097	0.9276	1.0533	1.2040
3	0.1568	0.3384	0.5370	0.7098	0.8664	1.0258	1.2029
4	0.2320	0.3339	0.4942	0.6682	0.8443	1.0275	1.2268
5	0.3566	0.4233	0.5453	0.7029	0.8806	1.0748	1.2879
6	0.5140	0.5683	0.6679	0.8075	0.9779	1.1732	1.3920
7	0.7012	0.7510	0.8397	0.9670	1.1286	1.3203	1.5396
8	0.9175	0.9656	1.0492	1.1691	1.3238	1.5109	1.7284
9	1.1627	1.2102	1.2913	1.4070	1.5570	1.7402	1.9551
10	1.4368	1.4840	1.5639	1.6772	1.8243	2.0044	2.2169

TABLE II
FREQUENCY PARAMETER FOR THE SOEDEL'S SHELL THEORY BY THE EXACT METHOD WITH $\frac{L}{R} = 3, \frac{h}{R} = \frac{1}{20}, \nu = \frac{1}{3}$

n	m=1	m=2	m=3	m=4	m=5	m=6	m=7
1	0.3660*	0.7044*	0.8473	0.9213	0.9924	1.0859	1.2142
2	0.1863*	0.4647	0.6695	0.8097	0.9276	1.0533	1.2040
3	0.1520*	0.3382*	0.5370	0.7098	0.8664	1.0258	1.2029
4	0.2320	0.3338*	0.4942	0.6682	0.8443	1.0275	1.2268
5	0.3565*	0.4233	0.5453	0.7029	0.8806	1.0748	1.2879
6	0.5140	0.5683	0.6679	0.8075	0.9779	1.1732	1.3920
7	0.7012	0.7510	0.8397	0.9670	1.1286	1.3203	1.5396
8	0.9174*	0.9655*	1.0491*	1.1690*	1.3238	1.5109	1.7284
9	1.1627	1.2101*	1.2913	1.4069*	1.5570	1.7402	1.9550*
10	1.4368	1.4840	1.5638*	1.6772	1.8242*	2.0044	2.2169

TABLE III
FREQUENCY PARAMETER FOR THE FLUGGE'S SHELL THEORY BY THE APPROXIMATION METHOD WITH $\frac{L}{R} = 3, \frac{h}{R} = \frac{1}{20}, \nu = \frac{1}{3}$

n	m=1	m=2	m=3	m=4	m=5	m=6	m=7
1	0.3676	0.7051	0.8479	0.9219	0.9929	1.0863	1.2147
2	0.1907	0.4672	0.6718	0.8119	0.9297	1.0551	1.2057
3	0.1680	0.3453	0.5425	0.7146	0.8708	1.0297	1.2064
4	0.2458	0.3455	0.5037	0.6764	0.8515	1.0340	1.2325
5	0.3709	0.4371	0.5578	0.7140	0.8906	1.0838	1.2959
6	0.5285	0.5828	0.6818	0.8207	0.9900	1.1842	1.4020
7	0.7158	0.7658	0.8543	0.9811	1.1421	1.3329	1.5514
8	0.9322	0.9805	1.0641	1.1838	1.3382	1.5247	1.7414
9	1.1775	1.2251	1.3064	1.4221	1.5719	1.7547	1.9691
10	1.4517	1.4991	1.5791	1.6926	1.8395	2.0195	2.2316

TABLE IV
FREQUENCY PARAMETER FOR THE FLUGGE'S SHELL THEORY BY THE EXACT METHOD WITH $\frac{L}{R} = 3, \frac{h}{R} = \frac{1}{20}, \nu = \frac{1}{3}$

n	m=1	m=2	m=3	m=4	m=5	m=6	m=7
1	0.3649*	0.7050*	0.8479	0.9219	0.9929	1.0863	1.2147
2	0.1900*	0.4672	0.6718	0.8119	0.9297	1.0551	1.2057
3	0.1681*	0.3453	0.5425	0.7146	0.8708	1.0297	1.2064
4	0.2457*	0.3455	0.5037	0.6764	0.8515	1.0340	1.2325
5	0.3710*	0.4371	0.5578	0.7140	0.8906	1.0838	1.2959
6	0.5285	0.5828	0.6818	0.8206*	0.9900	1.1842	1.4020
7	0.7158	0.7658	0.8543	0.9811	1.1420*	1.3329	1.5513*
8	0.9321*	0.9805	1.0641	1.1838	1.3381*	1.5246*	1.7414
9	1.1775	1.2251	1.3063*	1.4220*	1.5719	1.7545*	1.9690*
10	1.4517	1.4990*	1.5791	1.6925*	1.8395	2.0194*	2.2316

TABLE V
FREQUENCY PARAMETER FOR THE MORLEY-KOITER'S SHELL THEORY BY THE APPROXIMATION METHOD WITH $\frac{L}{R} = 3, \frac{h}{R} = \frac{1}{20}, \nu = \frac{1}{3}$

n	m=1	m=2	m=3	m=4	m=5	m=6	m=7
1	0.3673	0.7044	0.8467	0.9201	0.9905	1.0834	1.2112
2	0.1865	0.4644	0.6688	0.8085	0.9258	1.0508	1.2010
3	0.1565	0.3378	0.5361	0.7084	0.8645	1.0233	1.2000
4	0.2318	0.3332	0.4932	0.6668	0.8424	1.0252	1.2240
5	0.3565	0.4228	0.5443	0.7015	0.8788	1.0727	1.2853
6	0.5140	0.5680	0.6671	0.8064	0.9764	1.1713	1.3897
7	0.7013	0.7509	0.8392	0.9661	1.1274	1.3187	1.5377
8	0.9177	0.9656	1.0489	1.1685	1.3229	1.5097	1.7268
9	1.1630	1.2103	1.2912	1.4066	1.5564	1.7393	1.9539
10	1.4372	1.4843	1.5640	1.6771	1.8239	2.0038	2.2160

TABLE VI
FREQUENCY PARAMETER FOR THE MORLEY-KOITER'S SHELL THEORY BY THE EXACT METHOD WITH $\frac{L}{R} = 3, \frac{h}{R} = \frac{1}{20}, \nu = \frac{1}{3}$

n	m=1	m=2	m=3	m=4	m=5	m=6	m=7
1	0.3653*	0.7043*	0.8467	0.9201	0.9905	1.0834	1.2112
2	0.1870*	0.4644	0.6688	0.8085	0.9258	1.0508	1.2010
3	0.1563*	0.3377*	0.5361	0.7084	0.8645	1.0233	1.2000
4	0.2314*	0.3330*	0.4932	0.6667*	0.8423*	1.0251*	1.2240
5	0.3564*	0.4227*	0.5443	0.7014*	0.8788	1.0726*	1.2853
6	0.5140	0.5680	0.6671	0.8064	0.9763*	1.1712*	1.3897
7	0.7013	0.7509	0.8392	0.9661	1.1273*	1.3187	1.5377
8	0.9176*	0.9656	1.0489	1.1684*	1.3228*	1.5096*	1.7268
9	1.1630	1.2103	1.2912	1.4066	1.5564	1.7392*	1.9538*
10	1.4372	1.4843	1.5639*	1.6771	1.8239	2.0038	2.2160

TABLE VIII
FREQUENCY PARAMETER FOR THE DONNELL'S SHELL THEORY BY THE EXACT METHOD WITH $\frac{L}{R} = 3, \frac{h}{R} = \frac{1}{20}, \nu = \frac{1}{3}$

n	m=1	m=2	m=3	m=4	m=5	m=6	m=7
1	0.3674*	0.7039	0.8455	0.9179	0.9871	1.0787	1.2054
2	0.1858*	0.4642*	0.6680	0.8067	0.9229	1.0467	1.1958
3	0.1563*	0.3381*	0.5359	0.7074	0.8624	1.0201	1.1957*
4	0.2321*	0.3340*	0.4937	0.6666	0.8412*	1.0230*	1.2209*
5	0.3568*	0.4236*	0.5453*	0.7021	0.8787	1.0716*	1.2834
6	0.5143	0.5688	0.6683	0.8074*	0.9770	1.1712	1.3889
7	0.7015	0.7515*	0.8403	0.9673	1.1284	1.3193	1.5377*
8	0.9178	0.9662	1.0499	1.1697	1.3241*	1.5107*	1.7275
9	1.1631*	1.2108	1.2920*	1.4078*	1.5577*	1.7406	1.9549*
10	1.4373	1.4847	1.5647*	1.6782*	1.8252*	2.0052*	2.2174

TABLE VII
FREQUENCY PARAMETER FOR THE DONNELL'S SHELL THEORY BY THE APPROXIMATION METHOD WITH $\frac{L}{R} = 3, \frac{h}{R} = \frac{1}{20}, \nu = \frac{1}{3}$

n	m=1	m=2	m=3	m=4	m=5	m=6	m=7
1	0.3671	0.7039	0.8455	0.9179	0.9871	1.0787	1.2054
2	0.1867	0.4643	0.6680	0.8067	0.9229	1.0467	1.1958
3	0.1570	0.3382	0.5359	0.7074	0.8624	1.0201	1.1958
4	0.2323	0.3341	0.4937	0.6666	0.8413	1.0231	1.2210
5	0.3569	0.4237	0.5454	0.7021	0.8787	1.0717	1.2834
6	0.5143	0.5688	0.6683	0.8075	0.9770	1.1712	1.3889
7	0.7015	0.7516	0.8403	0.9673	1.1284	1.3193	1.5378
8	0.9178	0.9662	1.0499	1.1697	1.3242	1.5108	1.7275
9	1.1632	1.2108	1.2921	1.4079	1.5578	1.7406	1.9550
10	1.4373	1.4847	1.5648	1.6783	1.8253	2.0053	2.2174

In Table IX, results calculated by the exact and approximate methods according to the Soedel theory, are compared with an experiment held by Farshidianfar et al. [17]. The simply supported circular cylindrical shell investigated in Table IX is made of aluminum with material properties; $E=68.2\text{GPa}$, $\rho = 2700 \text{ Kg/m}^3$ and $\nu = 0.33$. The dimensions of the shell are; $L=1.7272 \text{ m}$, $R=0.0762 \text{ m}$ and $h=0.00147 \text{ m}$. Moreover, simulations were carried out using a Finite-Element model (FEM). The numerical results of the FEM are also presented in Table IX. The errors of all theories with respect to the experiment are also shown in this Table IX. It is observed that, the exact analysis yields very close results compared to the experiment as well.

TABLE IX
COMPARISON BETWEEN EXACT AND APPROXIMATION ANALYSIS WITH EXPERIMENTAL AND NUMERICAL DATA

m	n	Experiment (Hz)	Soedel (Exact) (Hz)	Soedel (App) (Hz)	Numerical(Hz)	Error/Soedel (Exact) (%)	Error/Soedel (App) (%)	Error Numerical (%)
1	1	138.40	139.469	141.446	134.897	0.8	2.2	2.5
1	2	190.30	172.351	176.692	184.280	9.4	-7.1	3.1
1	3	502.20	481.811	481.811	512.032	4.1	-4.1	-1.9
1	4	884.40	919.585	922.112	997.550	-4.0	4.3	-12.8
2	1	464.70	467.163	527.358	505.000	-0.5	13.5	-8.7
2	2	310.50	242.653	249.663		21.9	-19.6	
2	3	477.00	481.904	491.960	521.220	-1.0	3.1	-9.3
3	2	496.60	494.376	432.010		0.4	-13.0	0.4
3	3	558.90	490.975	525.499	551.305	12.1	-6.0	1.4
4	2	679.80	647.452	700.852	677.063	4.8	3.1	0.4
4	3	638.30	574.883	598.809	617.716	9.9	-6.2	3.2
5	3	782.00	789.188	720.163	729.710	-0.9	-7.9	6.6

As shown in Table IX, the exact method applied on the Soedel theory is found be much more accurate compared to the approximate method. It is very interesting that the exact method calculates the fundamental frequency $(m,n) = \{(1,1)\}$ with nearly no errors. Moreover, it is remarkable that the exact analysis predicts five resonance modes; $(m,n) = \{(1,1), (2,1), (2,3), (3,2), (5,3)\}$, with errors of equal or less than 1 percent. Although at some resonance frequencies the errors of the exact method are higher compared to the approximation, but, the difference in the errors are small and negligible. On the other hand the exact analysis has reduced

the errors of most frequencies dramatically. For example at mode shapes; $(m,n) = \{(2,1), (3,2)\}$, by using the exact analysis the errors of the approximate theory are reduced from 13 percent to less than 1 percent. On the contrary, some errors exist at low mode numbers for both the exact and approximate methods, especially for $(m,n) = \{(2,2)\}$. However, as the frequency increases the errors decrease. Thus, at high mode numbers the exact method of the Soedel theory is found to be in complete agreement with the experimental and numerical results. Such a trend is also observed for the approximate method, however, with higher errors for low mode numbers.

Finally, the FEM results are found to be in great agreement with the experimental results as well. It is interesting that the FEM is even more accurate than the theories discussed at some mode shapes. In Fig. 7 mode shapes are reported from the finite element analysis for $(m, n) = \{(1,1), (2,4), (3,3)\}$ modes.

In this section it was proved that, the exact method developed in this paper yields accurate results compared to experiment and theory.

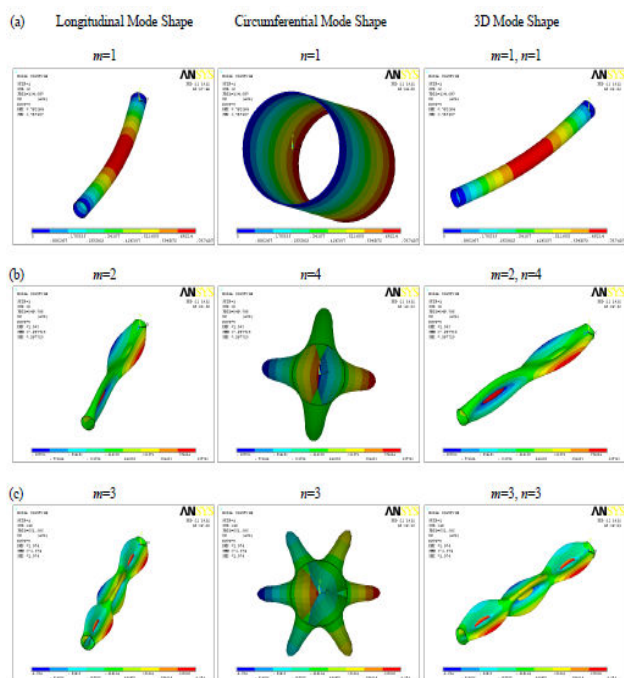

Fig. 7 Mode shapes of the circular cylindrical shell: (a) for $m=1, n=1$; (b) for $m=2, n=4$; (c) for $m=3, n=3$

V. CONCLUSION

The free vibration of circular cylindrical shells with simply supported boundary conditions has been studied using four different thin shell theories: Soedel, Flugge, Morley-Koiter and Donnell. The scope of the investigation was focused upon the exact analysis of natural frequencies. The approximate beam function method was also presented. First, a graphical representation of the exact analysis was presented, in order to find the natural frequencies of a shell. Next, exact results of the four theories were compared to approximate calculations. It was observed that, for low mode numbers the approximate method yield different results compared to the exact method whereas, for high mode numbers no significant discrepancies were noticed. Moreover, the approximate method based on the Soedel theory reviled better results compared to other theories. In order to check the accuracy of the exact method, a comparison was carried out with experimental and numerical results. According to this comparison the exact analysis predicted most of the resonance frequencies with errors of less than one percent. On the other hand the approximate method

yields high errors.

REFERENCES

- [1] W. Leissa, *Vibration of Shells* (NASA SP-288), US Government Printing Office, Washington DC, 1973.
- [2] M. Amabili, M. P. Paidoussis, "Review of studies on geometrically nonlinear vibrations and dynamics of circular cylindrical shells and panels, with and without fluid structure interaction," *Applied Mechanics Review*, vol. 56, pp. 349-381, 2003.
- [3] M. Amabili, *Nonlinear Vibrations and Stability of Shells and Plates*, Cambridge University Press, New York, USA, 2008.
- [4] Y. Kurylov, M. Amabili, "Polynomial versus trigonometric expansions for nonlinear vibrations of circular cylindrical shells with different boundary conditions," *Journal of Sound and Vibration*, vol. 329, pp. 1435-1449, 2010.
- [5] A. E. H. Love, *On the small free vibrations and deformations of thin shells*, Philosophical Transactions of the Royal Society (London) 179A, pp. 491-546, 1888.
- [6] W. Flugge, *Stresses in Shells*, Springer, New York, 1973.
- [7] K. K. Livanov, Axisymmetric "vibrations of simply supported cylindrical shells", *PMM*, Vol. 25, pp. 742-745, 1961.
- [8] S. A. Rinehart, J. T. S. Wang, "Vibration of simply supported cylindrical shells with longitudinal stiffeners," *Journal of Sound and Vibration*, vol. 24, pp. 151-163, 1972.
- [9] G. B. Warburton, J. Higgs, "Natural frequencies of thin cantilever cylindrical shells," *Journal of Sound and Vibration*, vol. 11, pp. 335-338, 1970.
- [10] C. B. Sharma, "Calculation of natural frequencies of fixed-free circular cylindrical shells," *Journal of Sound and Vibration*, vol. 35, pp. 55-76, 1974.
- [11] J. Callahan, H. Baruh, "A closed-form solution procedure for circular cylindrical shell vibrations," *International Journal of Solids and Structures*, vol. 36, pp. 2973-3013, 1999.
- [12] F. Moussaoui, R. Benamar, R. G. White, "The effects of large vibration amplitudes on the mode shapes and natural frequencies of thin elastic shells, Part I: Coupled transverse-circumferential mode shapes of isotropic circular cylindrical shells of infinite length," *Journal of Sound and Vibration*, vol. 232, pp. 917-943, 2000.
- [13] S. K. Tou, K. K. "Wong, High-precision finite element analysis of cylindrical shells," *Journal of Computers and Structures*, vol. 26, pp. 847-854, 1987.
- [14] J. W. Tedesco, C. N. Kostem, A. Kalnins, "Free vibration analysis of circular cylindrical shells," *Journal of Computers and Structures*, vol. 25, pp. 677-685, 1987.
- [15] A. B. Sabir, A. Sfendji, T. G. Hughes, "Strain-based finite element for the natural frequencies of cylindrical shells," *Journal of Thin-Walled Structures* vol. 18, pp. 67-82, 1994.
- [16] X. M. Zhang, G. R. Liu, K. Y. Lam, "Vibration analysis of thin cylindrical shells using wave propagation approach," *Journal of Sound and Vibration*, vol. 239, pp. 397-403, 2001.
- [17] A. Farshidianfar, M. H. Farshidianfar, M. J. Crocker, W. O. Smith, "The vibration analysis of long cylindrical shells using acoustical excitation," *Journal of Sound and Vibration*, vol. 232, pp. 917-943, 2010.
- [18] W. Soedel, *Vibrations of Shells and Plates*, 3rd ed., Marcel Dekker, Inc., 2004.
- [19] J. Callahan, *Cylindrical shell vibrations: Closed-form analysis and measurement via piezoelectric films*, PHD Dissertation, New Brunswick Rutgers, The State University of New Jersey, October 1997.