

Enhanced Performance of Fading Dispersive Channel Using Dynamic Frequency Hopping(DFH)

Walid M. Saad

Abstract—techniques are examined to overcome the performance degradation caused by the channel dispersion using slow frequency hopping (SFH) with dynamic frequency hopping (DFH) pattern adaptation. In DFH systems, the frequency slots are selected by continuous quality monitoring of all frequencies available in a system and modification of hopping patterns for each individual link based on replacing slots which its signal to interference ratio (SIR) measurement is below a required threshold. Simulation results will show the improvements in BER obtained by DFH in comparison with matched frequency hopping (MFH), random frequency hopping (RFH) and multi-carrier code division multiple access (MC-CDMA) in multipath slowly fading dispersive channels using a generalized bandpass two-path transfer function model, and will show the improvement obtained according to the threshold selection.

Keywords—code division multiple access (CDMA), dynamic channel allocation (DCA), dynamic channel assignment, frequency hopping, matched frequency hopping (MFH).

I. INTRODUCTION

MANY techniques have been used to combat impairments in rapidly varying radio channels and to obtain high spectral efficiencies in cellular systems. Some of those are channel coding and adaptive modulation, interleaving, transmitter/receiver antenna diversity, spread spectrum, and dynamic channel allocation (DCA). This paper presents the results of simulation studies of the combined effects of frequency-hopping and a special form of dynamic channel allocation (DCA) manifested by frequency-hop pattern adaptation [1]–[5].

Frequency hopping (FH) can introduce frequency diversity and interference diversity. It can be an effective technique for combating Rayleigh fading, reducing interleaving depth, associated delay, and enabling efficient frequency reuse in a multiple access communication system [6]–[8]. The use of frequency hopping is very important in many applications such as GSM system. DCA, similarly to FH, can provide higher spectrum efficiency than fixed frequency assignment strategies.

The main idea of DFH incorporates a non-traditional DCA scheme with SFH. The main objective is to provide interference avoidance which are higher than those provided by conventional frequency hopping while preserving interference averaging characteristics of conventional frequency hopping in order to provide robustness to rapid changes in interference. The key

concept lying behind this intelligent frequency hopping technique is to adjust or create frequency hopping patterns based on interference measurements. DFH uses slow frequency hopping and adaptively modifies the utilized FH pattern based on rapid frequency quality measurements [9].

The continuous modification of frequency hop patterns based on measurements represents an application of DCA to SFH. However, the fact that only some subset of frequencies in the whole FH pattern is replaced by a better quality subset makes this a non-traditional DCA scheme. DFH relies on continuous quality monitoring of all frequencies available in a system and modification of hopping patterns for each individual link. The measurements of all frequencies can be done in practice in traditional time division multiple access (TDMA) systems (at lower speeds) or in systems using orthogonal frequency division multiplexing (OFDM).

The patterns can be updated in different ways. Three methods for FH pattern modifications are acknowledged:

- 1-full replacement method, where all the frequencies used in a pattern are replaced with better ones in the next period.
- 2-worst dwell method, where only one frequency (the lowest quality one) in a frequency-hop pattern is changed.
- 3-SIR threshold based method, where a subset of currently used frequencies is changed based on SIR measurements on the frequencies of a pattern.

The focus here is on the concept, named SIR threshold based method DFH, using SFH and adaptively modifying the utilized frequency-hop patterns. The continuous modification of patterns based on measurements represents an application of DCA to slow frequency hopping. Since only a part of the channel is replaced, namely, some subset of frequencies in the frequency hop pattern is replaced by a better quality subset. The current hopping pattern is changed if the measured SIR is below a required threshold on at least one of the frequencies. Instead of replacing all the frequencies as was the case in the full replacement method, only this low quality frequency (or frequencies) is replaced with a new one. This frequency can be replaced by any frequency meeting the threshold SIR. Therefore, there is no need for all the frequencies to be scanned (to find the best one), and the frequency updates are performed whenever necessary instead of periodically as was the case in the worst dwell method which reduces the messaging overhead. DFH attempts to track the variability of interference conditions and mitigate it by FH pattern adaptation.

II. SFH/BFHK SIGNALS IN DISPERSIVE CHANNELS

In a FH system with a frequency-shift-keying (FSK) carrier modulation (FH/FSK) system, the signals can be thought of as

FSK carrier modulated signals in which the carrier frequency hops from one frequency slot to the other within the available channel bandwidth. SFH signals for which one hopping-time interval includes one or more data bits with binary frequency shift keying (BFSK) carrier modulation (SFH/BFSK) are considered. The FSK modulator produces a BFSK signal of carrier frequency f_c . The BFSK is then mixed with a subcarrier signal of a stepwise variable frequency $f_H(t)$ that is generated by a frequency synthesizer controlled by k chips of a long PN sequence. Within a hopping interval, the subcarrier frequency $f_H(t)$ takes one value of $L = 2^k$ possible values that form a set of frequencies $(f_0, f_1, \dots, f_{L-1})$ where f_j may be a positive or negative frequency shift, and the frequency of the FH carrier $F(t)$ is thus given by

$$F(t) = F_j = f_c + f_j, \quad jT_h \leq t \leq (j+1)T_h \quad (1)$$

The transmitted signal $s(t)$ is given by

$$s(t) = \sqrt{2P} \cos(2\pi(F_j + b_i\delta)t + \phi_j^i), \quad \begin{matrix} iT_b \leq t \leq (i+1)T_b \\ jN_b \leq i \leq (j+1)N_b \end{matrix} \quad (2)$$

where δ is half the spacing between the BFSK tones, $\phi_j^i = \theta_i + \alpha_j$, θ_i is the carrier phase at frequency $f_c + b_i\delta$, α_j is the phase produced through the frequency translation process, b_i is the i^{th} bit data, $T_b = 1/R_b$ is the bit duration, and P is the average power of the transmitted BFSK signal.

The receiver structure for an SFH/BFSK system is shown in Fig.1. The input bandpass filter BPF1 is of bandwidth $BW_1 = B_T$ that is centered at the carrier frequency f_c to reject out-of-band noise and interference. The received FH signal is mixed with a local subcarrier of frequency $f_H(t)$ generated by a frequency synthesizer that is controlled by a PN-code generator to produce the same PN sequence used by the transmitter and is assumed to be synchronized with it. The second bandpass filter BPF2 is centered at f_c , and its bandwidth BW_2 satisfies $2(\delta + 1/T_b) < BW_2 < \delta'$ in order to pass the BFSK signal and to allow only one FH channel to pass through, where δ' is the width of FH slots. The BFSK signal at the output of BPF2 is then demodulated by a conventional incoherent demodulator comprising two bandpass filters followed by two envelope detectors. The two received envelopes are then sampled and compared at the time instance $jT_h + (i+0.5)T_b$ to determine whether the i^{th} transmitted data bit is +1 or -1. Assuming that each of the noise signals at the inputs of the two envelope detectors to be bandpass additive white Gaussian noise (AWGN) with equal power N , it can be directly shown that the probability of error in demodulating the BFSK signal for the j^{th} frequency hopped slot is given by

$$P_j(E) = 0.5e^{(-x_j/2)} \quad (3)$$

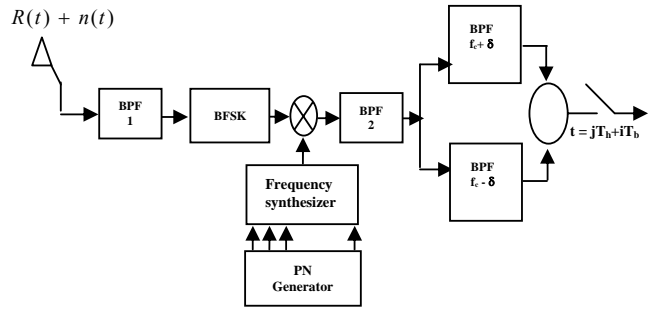

Fig. 1. Block diagram of the SFH/BFSK receiver system.

where $P_j(E)$ is the probability of error in demodulating the BFSK signal for the j^{th} frequency hopped slot, $x_j = A_j^2/2N$ and A_j is the magnitude of the j^{th} FH. The average probability of error is given by [10]

$$P(E) = \sum_{j=0}^{L-1} P(j)P(E/j) = \frac{1}{2L} \sum_{j=0}^{L-1} e^{(-x_j/2)} \quad (4)$$

III. MFH, MC-CDMA AND DFH

A. Matched Frequency Hopping

Instead of using the FH pattern uniformly or randomly which causes performance degradation and possibilities of transmission failure, the FH pattern is matched to the channel. This selection of frequency slots is concentrated in the frequency subbands which are characterized by high channel transmission coefficients and made sparse or even prevented in the frequency slots which correspond to relatively high attenuation or bad transmission. Mathematically, this is equivalent to selecting a nonuniformly distributed FH pattern and its probability density function (pdf) $P_F(f)$ in the available channel bandwidth is proportional to the channel transmission coefficient $|H(f)|^2$.

$$P_F(f) = \begin{cases} K|H(f)|^2 & f \in W \\ 0 & O.W \end{cases} \quad (5)$$

where the constant K is selected such that the integration of $P_F(f)$ over the available channel bandwidth is equal to unity. This selection of the pdf of the FH carrier frequencies F_j assures that these frequencies will be concentrated in frequency regions with minimum attenuation.

After specifying the pdf of the FH pattern, it is needed now to solve the inverse problem, namely, how to determine the channel-matched FH patterns. If one starts with the usual case of uniformly distributed FH frequencies in which F can be treated as a uniformly distributed random variable (rv), denoted by X in the domain $(0, 1)$, a transformation that yields another (rv) with the pdf function given by (5) is needed. It can be easily shown that this transformation is given by [11]

$$F_j = Q(x_j) \tag{6}$$

where $Q(x_j)$ is the inverse transformation

$$Q(x_j) = P_F^{-1}(x_j) \tag{7}$$

and

$$P_F(x) = \int_{f_a}^x P_F(f) df = K \int_{f_a}^x |H(f)|^2 df \tag{8}$$

i.e., $P_F(x)$ is the cumulative probability distribution function (cdf) of F . In (8), f_a is the lower frequency edge of the channel bandwidth. In (6) and (7), x_j is a sample value of the uniformly distributed rv X , with $0 \leq x_j \leq 1$. If f_b is the upper frequency edge of the channel bandwidth and f_c is its center frequency, the maximum number of available frequency slots M is given by $M = W/\delta = (f_b - f_a)/\delta$, and it is assumed to be greater than the number of transmitted slots L . The L channel matched transmitted FH slots can be selected from the M -available frequency slots by the transformation (6) as shown in Fig. 2 for the assumed channel model.

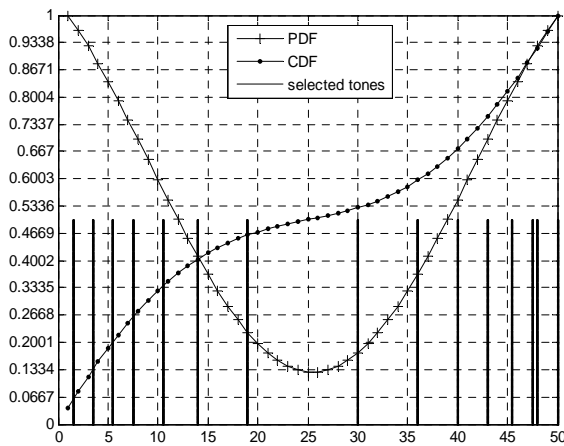

Fig. 2. Graphical representation of how MFH pattern is selected from all the available tones. The MFH pattern is 15 matched frequency tones out of 50 available tones in the allowed transmission bandwidth.

B. Multi-carrier CDMA

The basic MC-CDMA signal is generated by a serial concatenation of classical DS-SS and OFDM. Each chip of the direct sequence spread data symbol is mapped onto a different sub-carrier. Thus, with MC-CDMA the chips of a spread data symbol are transmitted in parallel on different sub-carriers. Fig. 3 shows multi-carrier spectrum spreading of one complex-valued data symbol $d^{(k)}$ assigned to user k . The rate of the serial data symbols is $1/T_d$. For brevity, but without loss of generality, the MC-CDMA signal generation is described for a single data symbol per user as far as possible, such that the data symbol index can be omitted. In the transmitter, the complex-

valued data symbol $d^{(k)}$ is multiplied with the user specific spreading code of length $L = P_G$.

$$c^{(k)} = (c_0^{(k)}, c_1^{(k)}, \dots, c_{L-1}^{(k)})^T \tag{9}$$

The chip rate of the serial spreading code $c^{(k)}$ before serial-to-parallel conversion is

$$\frac{1}{T_c} = \frac{L}{T_d} \tag{10}$$

and it is L times higher than the data symbol rate $1/T_d$. The complex-valued sequence obtained after spreading is given in vector notations by

$$s^{(k)} = d^{(k)} c^{(k)} = (s_0^{(k)}, s_1^{(k)}, \dots, s_{L-1}^{(k)})^T \tag{11}$$

A multi-carrier spread spectrum signal is obtained after modulating the components $s_l^{(k)}$, $l = 0, \dots, L-1$, in parallel onto L sub-carriers. With multi-carrier spread spectrum, each data symbol is spread over L sub-carriers. When the number of sub-carriers N_c of one OFDM symbol is equal to the spreading code length L , the OFDM symbol duration with multi-carrier spread spectrum including a guard interval results in

$$T_s' = T_g + LT_c \tag{12}$$

In this case one data symbol per user is transmitted in one OFDM symbol.

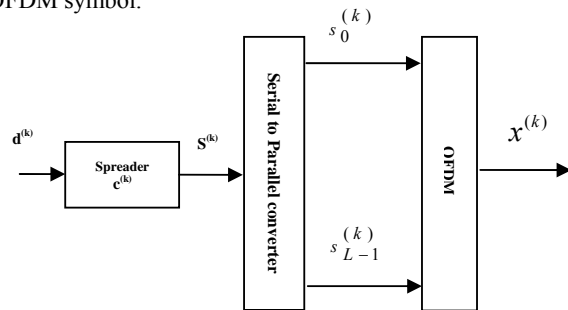

Fig. 3. Multi-carrier spread spectrum signal generation

After serial to parallel converter and inverse OFDM, the received vector of the transmitted sequences $s^{(k)}$ is given by

$$r = \sum_{k=0}^{K-1} H^{(k)} s^{(k)} + n \tag{13}$$

where $H^{(k)}$ contains the coefficients of the sub-channels assigned to user k .

C. Dynamic Frequency Hopping Scheme

The difference of DFH from conventional frequency hopping is in the way the patterns are built. Instead of using random or pre-defined repetitive hopping patterns, in DFH the

hopping patterns are generated on the fly. With this technique, the hopping patterns can be modified to adapt to interference changes [12]. The length of the patterns is limited. The main idea behind creating the patterns is to choose the best frequency for each hop which would correspond to the least interfered frequency. Hence, DFH requires continuous estimation and measurement of the interference at every frequency for every single hop of a pattern as shown in Fig.4.

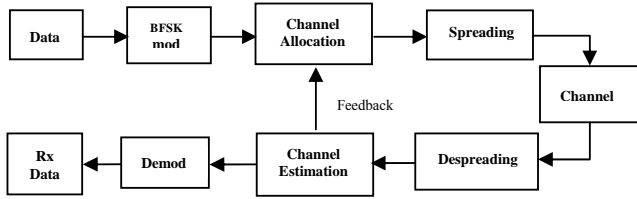

Fig. 4. Block diagram of system model for DFH.

At each hopping instant the, quality of each frequency should be measured, then the measurement is filtered to average out the instantaneous Rayleigh fading effects, and then sends the data using the best frequencies chosen according to some quality criterion. For the sake of minimizing system instability and complexity, the number of hopping frequencies that change at every hop can be limited.

IV. OUTAGE PROBABILITY CALCULATION FOR SIR THRESHOLD BASED METHOD

SIR threshold based method is investigated because there is no need for all the frequencies to be scanned to find the best one and the frequency updates are performed whenever necessary instead of periodically, which reduces the messaging overhead. In the least interference hopping scheme, the n frequencies with the least interference power are chosen in every successive hop. I_j is the j^{th} least interference power among the N frequencies; then the distribution of I_j is given by

$$F_{I_j} = \sum_{k=j}^M \binom{M}{k} F_I(x)^k (1 - F_I(x))^{N-k} \quad (14)$$

The outage probability at the j^{th} frequency is then given by

$$P\left[\frac{S}{I_j} \leq \eta\right] = 1 - P\left[I_j \leq \frac{S}{\eta}\right] = \int_0^{\infty} dx F_{I_j}\left(\frac{x}{\eta}\right) f_s(x) \quad (15)$$

V. CHANNEL MODEL

One of the most popular channel model which is suggested by Rummeler [13] was based upon extensive field data. The channel transfer function is modeled as a pseudo two-path transfer function on the form

$$H(f) = s[1 - he^{-j2\pi(f-f_0)\tau}] \quad (16)$$

where s and h are the scale and shape factor, f_0 is the frequency of fade minimum, and τ is the path delay difference. The factor s can be considered as the flat fading level. This model is more general than a two-ray multipath channel model [14]. It can be modified to account for the finite channel bandwidth [15], and the normalized channel transmission coefficient is given by

$$\begin{aligned} |H(F_j)|^2 = & s^2 [(1 - h \cos(2\pi(f_j - f_{off})\tau))]^2 \\ & + h^2 \sin^2(2\pi(f_j - f_{off})\tau) \prod (f_j/W) \end{aligned} \quad (17)$$

where $f_{off} = f_0 - f_c$ is the frequency offset of the fade minimum from the band center frequency and $\prod(f/W)$ is the unit magnitude gate function of width W in the frequency domain, $f_{null} = f_{off}/W$ is the normalized fading null frequency offset from band center, and $D = W\tau$ is the normalized relative delay.

VI. SIMULATIONS

Simulation studies pursued to evaluate the benefits of dynamic frequency hopping in the proposed slowly fading dispersive channel, BFSK modulation is used. Measurements assumed to be ideal and have the ability to estimate the interference power. SIR Threshold Based Method technique is investigated. The performance is expressed by BER illustrating the performance of DFH compared to random FH, Multi carrier CDMA, and MFH. Assuming that the channel model parameters $S = -3$ dB, $h = 0.5$, normalized fading null frequency offset from band center $f_{null} = 0$, the normalized relative delay $D = 0.75$, and $SNR = 4$ dB.

Fig.5 shows that the performance of MFH is better compared to DFH when the number of subcarriers = 7 and the threshold = 4dB, but in Fig.6 the performance of DFH is improved and became better than MFH when the number of subcarriers = 15. Fig.7 shows that DFH technique improves the system performance compared to RFH and MC-CDMA, and Fig. 8 shows that as the threshold of DFH technique increases the system performance getting better.

VII. CONCLUSION

In this paper, the performance of SIR threshold based method DFH applied to slowly fading dispersive channel. The simulation results illustrate that DFH is an efficient technique for spread spectrum signaling in slowly fading dispersive channel. As shown in simulation results the performance of DFH technique is getting better compared to MFH and the performance of MFH is getting worse as the number of hopping subcarriers increases. When the number of slots = 7 the BER of MFH = 0 at $SNR = 11$ dB and the BER of DFH = 5×10^{-3} at $SNR = 20$ dB, but when the number of slots = 15 the BER of MFH = 0.1711 and the BER of DFH = 7.556×10^{-3} at $SNR = 20$ dB. The performance of MC-CDMA and RFH in proposed channel is almost the same i.e. when the number of slots = 31 the BER of MC-CDMA = 5.714×10^{-3} and the BER of RFH = 7.013×10^{-3} at $SNR = 20$ dB, whenever the BER of DFH = 0 at $SNR = 7$ dB. So, DFH improve the performance compared to random FH and multi carrier CDMA.

The choice of thresholds can provide systems with performance in the range between dynamic frequency hopping and random frequency hopping. And as the threshold increases the pattern selection becomes better and so the performance is improved but it should be limited according to the channel and the required length of hopping tones to detect the best tones from the available bandwidth.

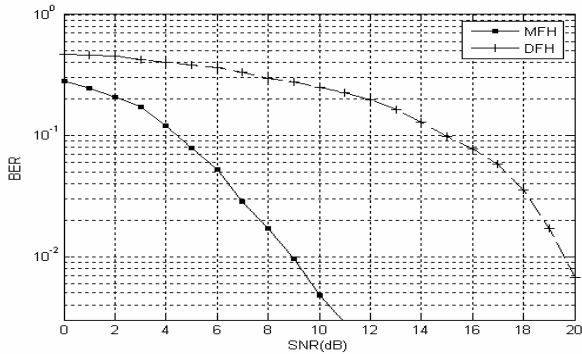

Fig. 5. Comparative performance of dynamic and matched frequency hopping when number of hopping slots=7.

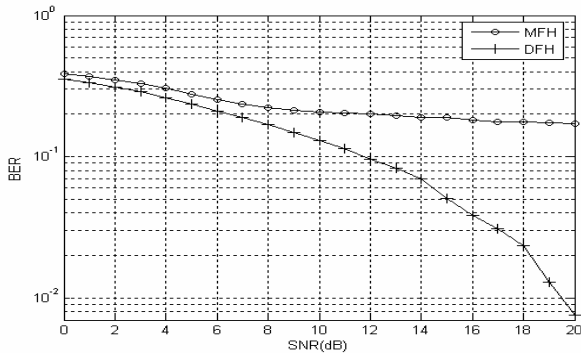

Fig. 6. Comparative performance of dynamic and matched frequency hopping when number of hopping slots=15.

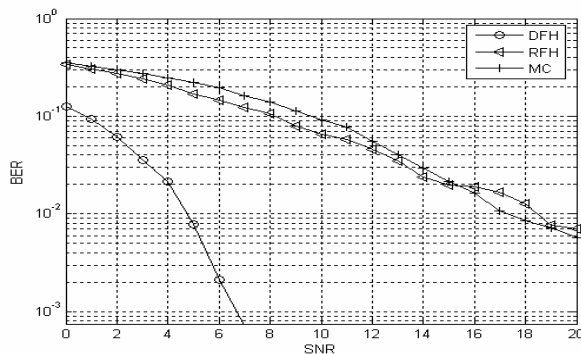

Fig. 7. Comparative performance of dynamic, random frequency hopping and MC-CDMA when number of hopping slots=31.

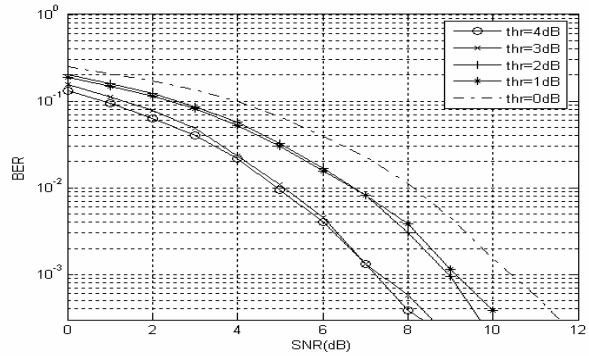

Fig. 8. Illustrating the performance of dynamic frequency hopping as the threshold increases.

REFERENCES

- [1] X.Wang and Z. Kostic, "Analysis of frequency-hopped cellular systems with dynamic FH pattern adaptation," in Proc. IEEE Globecom, Communications Theory Mini Conf., Sydney, Australia, Nov. 1998.
- [2] Z. Kostic and I. Maric, "Dynamic frequency hopping in wireless cellular systems—simulations of full-replacement and reduced-overhead methods," in Proc. IEEE VTC'99, Houston, TX, May 1999.
- [3] Q. C. Chen et al., "MulticarrierCDMAwith adaptive frequency hopping for mobile radio systems," IEEE J. Select. Areas Commun., vol. 14, pp.1852–1858, Dec. 1996.
- [4] C. C. Wang and G. Pottie, "Interference avoidance and power control strategies for coded frequency hopped cellular systems," in Proc. IEEE Int. Conf. Communications (ICC), 1995, pp. 1737–1741.
- [5] W. Hu, D. Willkomm, L. Chu, M. Abusubaih, J. Gross, G. Vlantis, M. Gerla, and A. Wolisz, "Dynamic frequency hopping communities for efficient IEEE 802.22 operation," IEEE Commun. Mag., Special Issue: "Cognitive Radios for Dynamic Spectrum Access", vol. 45, no. 5, pp. 80–87, May 2007.
- [6] C. C. Lee and R. Steele, "Signal to interference calculations for modern TDMA cellular communication systems," Proc. Inst. Elect. Eng. Commun., vol. 142, pp. 21–30, Feb. 1995.
- [7] M. Chiani et al., "Outage evaluation for slow frequency-hopping mobile radio systems," IEEE Transactions on Communications, vol. 47, pp. 1865–1874, Dec 1999.
- [8] J. Moon, L. Hughes, and D. Smith, "Assignment of frequency lists in frequency hopping networks," IEEE Trans. Veh. Technol., vol. 54, no. 3, pp. 1147–1159, 2005.
- [9] D. Hollos, D. Willkomm, J. Gross, and W. Hu, "Centralized vs. distributed frequency assignment in frequency hopping (cognitive radio) cellular networks," Telecommunication Networks Group, Technische Universit at Berlin, Tech. Rep. TKN-07-007, Dec. 2007.
- [10] Said E. El-khamy "Matched frequency-hopping (MFH) signals for slowly fading dispersive channel" IEEE Transactions on Vehicular Technology, vol. 47, NO. 1, Feb 1998.
- [11] C.W. Helstrom, Probability and Stochastic Processes for Engineers. New York: Macmillan, 1984.
- [12] L. Chu, W. Hu, G. Vlantis, J. Gross, M. Abusubaih, D. Willkomm, and A. Wolisz, "Dynamic frequency hopping community," online, IEEE 802.22 Working Group, Technical proposal submitted to IEEE 802.22 WG 22-06-0113, Jun. 2006.
- [13] W. D. Rummler, "A new selective fading model: Application to propagation data," Bell Syst. Tech. J., vol. 59, no. 5, pp. 1037–1071, May–June 1979.
- [14] C. A. Siller Jr., "Multipath propagation," IEEE Commun. Mag., vol. 22, no. 2, pp. 6–15, 1984.
- [15] S. E. El-Khamy and A. M. Dobaie, "Propagation-medium matched direct-sequence (PM-MDS) spread-spectrum signals," IEEE Trans. Antennas Propagat., vol. 39, pp. 1449–1456, Oct. 1991.