

Emergency Generator Sizing and Motor Starting Analysis

Mukesh Kumar Kirar, Ganga Agnihotri

Abstract—This paper investigates the preliminary sizing of generator set to design electrical system at the early phase of a project, dynamic behavior of generator-unit, as well as induction motors, during start-up of the induction motor drives fed from emergency generator unit. The information in this paper simplifies generator set selection and eliminates common errors in selection. It covers load estimation, step loading capacity test, transient analysis for the emergency generator set. The dynamic behavior of the generator-unit, power, power factor, voltage, during Direct-on-Line start-up of the induction motor drives fed from stand alone gene-set is also discussed. It is important to ensure that plant generators operate safely and consistently, power system studies are required at the planning and conceptual design stage of the project. The most widely recognized and studied effect of motor starting is the voltage dip that is experienced throughout an industrial power system as the direct online result of starting large motors. Generator step loading capability and transient voltage dip during starting of largest motor is ensured with the help of Electrical Transient Analyzer Program (ETAP).

Keywords—Sizing, induction motor starting, load estimation, Transient Analyzer Program (ETAP).

I. INTRODUCTION

It is extremely important to initially select the correct generator set due to high initial cost of generator sets, the installation, and other equipment involved [1]. The generator rating is not necessarily to be just sum of the loads if some non-linear loads present. Conventionally that may be taken care by margin factor but to determine a cost effective as well as project required rating of generator, effective loads on generator must be calculated properly to avoid generator over sizing [2], [3].

Dynamic conditions of generator-unit are interesting in case of smaller, often isolated electrical grids. Induction machine play a very important role in the industrial applications and a significant number of induction motors are used at critical points of on board processes [4]. As compared to a utility bus feed, an on-site Gene-set is a limited source of horsepower, from the engine, and kVA from the generator. Thus, a gene-set must be large enough to start as well as run connected motor loads. At start, an induction motor draws heavy surge of current from the power system that in turn causes a dip in system voltage [5]. Flicker can create a problem to both the generator and the connected loads. The basic requirement for studying starting analysis of Induction motor are the starting

current of induction motor and the voltage flicker during start up [6]. During motor starting, the voltage level at the motor terminals should be maintained at approximately 80 percent of rated voltage [7]. Factors affecting motor starting include impedance of power distribution systems, the motor terminal voltage, inertia of the motor and the load. System impedance has impact on both starting current and motor terminal voltage. Its impact on the voltage is much greater than on the current. The starting current using across-line starting is only slightly different when the impedance of the circuit is changed, but the voltage drop on the cable changes significantly [8].

II. SYSTEM DESCRIPTION

A single line diagram (SLD) of a power distribution system of a large Oil Storage Terminal (OST) is shown in Fig. 1. To improve system reliability and power quality, the ICP has Grid connectivity with public power company (PPC) at two points. PPC power is available at 66 kV voltage level through utility ties 1 and 2. Grid transformers TR-301 and TR-302 step down the voltage from the 66 kV level to the 6.9 kV level and connected to Switchgear SG-201A and SG-201B through cable respectively. The power is primarily distributed at a 6.6 kV level from two main receiving Switchgear panel SG-201A and SG-201B. Emergency load is connected to MCC-401 and MCC-402 and SG-402A and SG-402B panel. Generator rating is calculated according to the load on the buses MCC-401 and MCC-402 and SG-402A and SG-402B. When the plant becomes isolated, due to a utility service outage generator will supply power to emergency load. Emergency power is generated at 6.6kV and supplied to load through generator transformer TR-405 of 6.6/0.415kV.

III. STEPS FOR GENERATOR SIZING

Step -1: Segregation of Loads

It is important to gather a reasonably accurate load schedule as soon as possible for determining generator rating as well as overall system design. The detailed loads equipment information is not available at early stage in project. The primary sizing calculation have to be made based on estimates and assumptions and the same must be iterated as more accurate information becomes available progressively. After accumulation of load list it is necessary to segregate the loads in different application categories as listed below:

- **Category-1:** Linear loads like lighting, heating etc. in kW (KW^1) and its overall pf (PF^1)
- **Category-2:** Running highest motor or a group of motors

Mukesh Kumar Kirar, assistant professor, Electrical Engineering, MANIT Bhopal, Madhya Pradesh, India (e-mail: mukeshkirar@rediffmail.com).

Ganga Agnihotri, professor, Electrical Engineering, MANIT Bhopal, Madhya Pradesh, India (e-mail: ganga1949@gmail.com).

to be started at a time or sum of auto accelerated motor loads input power in kW (KW^s) and its other parameters

like pf (PF^s), starting current (I^s), starting pf (PF^{ss}) and starting time (t^s) based on load type.

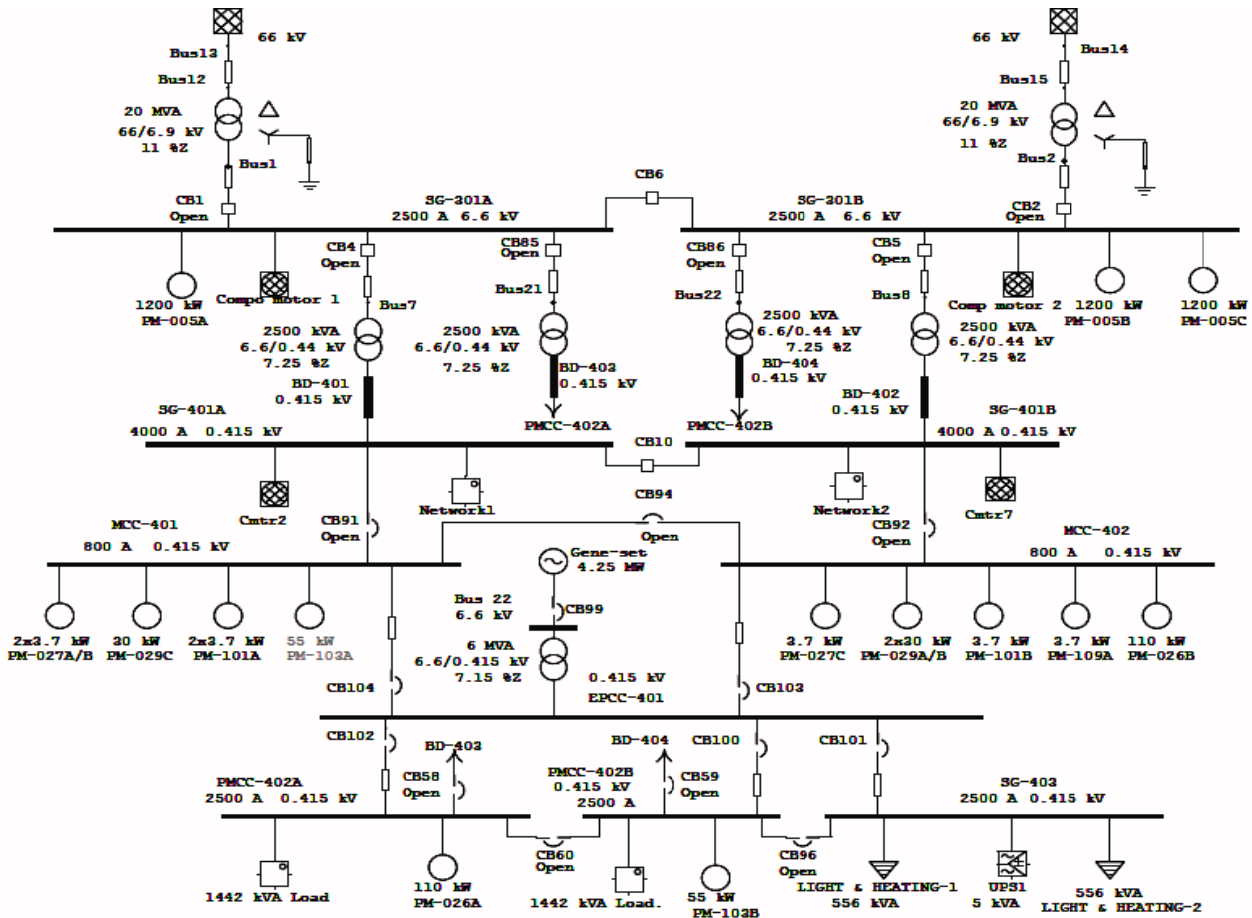

Fig. 1 Single line diagram (SLD) of OST

- **Category-3:** Running motor loads except VFD and soft started input power in kW (KW^m) and its overall pf (PF^m)
- **Category-4:** UPS input power in kW (KW^u) and its overall pf (PF^u)
- **Category-5:** Soft started motor input power rating in kW (KW^f) and its overall pf (PF^f)

Step-2: Effective Load to Generator

It is important to note that generator rating is not necessarily to be just sum of the loads if some non-linear loads present. Conventionally that may be taken care by margin factor but to determine a cost effective as well as project required rating of generator, effective loads on generator must be calculated properly to avoid generator over sizing. Effective load to generator to be calculated as below based on load segregation done in step-1

$$kW_e = kW^l + kW^s + kW^m + N^u * kW^u + N^f * kW^f + kW \quad (1)$$

N^u = 1.25 * 1.4 for 1 phase and 6 pulse UPS and 1.25* 1.15 for 6 pulse UPS with input filters or 12 pulse UPS. Factor 1.25

is considered to take the battery charging after drain out with supplying connected loads.

N^f = 1.15 for without bypass contactor after start and 1.0 for with bypass contactor after start

Effective KVA rating of the generator is

$$kVA_e = \frac{kW_e}{pf_{overall}} \quad (2)$$

Step-3: Overload Capacity

Overloading has to be checked with respect to short time kVA rating not the short time kW rating. During starting, kW is low due to low starting power factor whereas line current still continues to 5-7 times of full load current up to 80% of rated motor speed even though power factor increased to nearly 0.7 to 0.8. In case of firewater pump connected to generator, voltage dip of 15% only to be considered during starting as per NEC. Even if firewater pump starter is fitted with reduced voltage starting, DOL to be considered for generator sizing keeping in view criticality of fire water pump.

Considering starting load, short time total kVA load rating to be calculated as below without considering correction

factors for non-linear loads.

$$kVA_s = \frac{kW^l}{PF^l} + \frac{I^s \times K^r \times kW^s}{PF^s} + \frac{kW^m}{PF^m} + \frac{kW^u}{PF^u} + \frac{kW^f}{PF^f} + \frac{kW}{PF} \quad (3)$$

where K^r is to be selected from IEEE Std 399-1997

$$kVA_s < kVA_e * K^{overload} \quad (4)$$

However, if no data is available on overload capacity $K^{overload} = 1.5$ could be considered and suitability to be checked.

If above relationship is not fulfilled,

$$kVA_e(\text{corrected in Step - 3}) = \frac{kVA_s}{K^{overload}} \quad (5)$$

Step-4: Step Loading Capacity

Step loading has to be checked with respect to short time kW rating not with respect to the short time kVA rating. The effect of step load is much more on engine/governor which is responsible to deliver the desired kW. Step loading capacity is fully depends on engine type and associated governor type/response time. Usually governor type is unknown during initial phase of project and conservatively maximum 40% engine capacity could be considered as a permissible step load. Again maximum starting load in kW shall be selected as maximum step load. So the relationship given below is to be checked considering 40% allowable step load. In case accurate step load factor is obtained from vendor, the same is to be applied instead of 0.4.

$$\frac{kW^s * I^s * K^r * PF^{ss}}{PF^s} < kVA_e * (P.F. \text{ of Generator}) * (\text{Step Loading Factor}) \quad (6)$$

If it is not fulfilled,

$$kVA_e(\text{corrected in Step 4}) = \frac{kW^s * I^s * K^r * PF^{ss}}{PF^s * (P.F. \text{ of Gene}) * (\text{Step Loading Factor})} \quad (7)$$

Step-5: Transient Voltage Dip

The instantaneous transient voltage dip occurs during starting of motor, is strictly a function of the relative impedances of the generator and motor. Gen-set's ability to start large motors without excessive voltage and frequency dip is a function of the complete system.

Excitation systems that responds too quickly or too stiff can actually overload the engine when starting large motors. In general generator has to recover voltage at least up to 90% of rated voltage utmost by few cycles. If the motor does not reach near rated operating speed after few seconds (say 4 to 10 sec), a heavy voltage and frequency dip may occur. It is to be noted that manual calculation of transient voltage drop does not lead to any conclusive result. The exciter type, AVR voltage change rate, and time constants of exciter are major factors to determine whether generator is capable to recover to 90% voltage after transient dip. Keeping in mind this aspect, transient voltage dip at motor starting could be calculated by very simplified method ignoring other parameters of network

like cables and running loads.

$$\%V_d = \frac{X''_d * 100}{X''_d + kVA_e (PF^s / (kW^s * I^s * K^r))} \quad (8)$$

$$V_{dt} > \frac{X''_d * 100}{X''_d + kVA_e (PF^s / (kW^s * I^s * K^r))} \quad (9)$$

where V_{dt} is allowable voltage dip

If above relationship is not fulfilled

kVA_e Corrected in step-5

$$kVA_e(\text{corrected in step - 5}) = \frac{kW^s * I^s * K^r}{PF^s} * X''_d * \left(\frac{100}{V_d} - 1 \right)$$

Step-6: Generator Rating

Generator electrical kW (kW_e) calculated

$$(kW_e) = \text{Generator kVA (kVA}_e) * 0.8 (\text{Gene p.f.}) \quad (10)$$

Engine i.e. mechanical kW (kW_m) selected

$$kW_m = kW_e \text{ selected} / \text{efficiency of engine} \quad (11)$$

Suitable design / future margin, normally 10 to 30%, should be applied on above calculated kVA_e rating and round off to nearest rating available in market.

After exercising all of above five steps, Generator rating shall be maximum rating out of calculation from step-2 to step-5. According to different application categories, the load is segregated in Table I. Flow chart for generator sizing is given in Fig. 2. The generator rating selected after the calculation is 5MVA. The generator parameters which are considered in the study are depicted in Table V of appendix.

TABLE I
LOAD LIST

Type of the Load	kW	P.F.	kW/Pf
Lighting/Heating Load (kW^l)	1000	0.9	1111
Highest Motor Load (DOL) (kW^h)	110	0.85	129.4
Running Motor Load (kW^m)	74.8	0.86	86
UPS Load (12 Pulse) (kW^u)	4	0.8	5
Soft Started Motor Load (kW^f)	55	0.85	64.7
Miscellaneous kW	2650	0.85	2887
Total	3893		4515

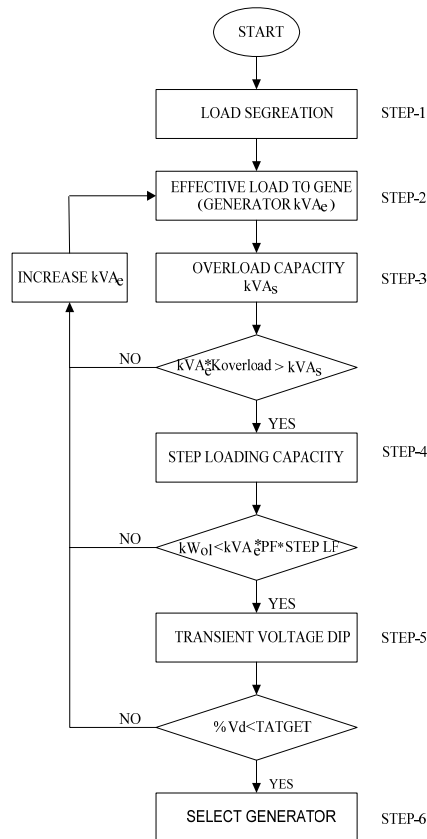

Fig. 2 Flow chart for generator sizing

IV. MOTOR STARTING ANALYSIS

To investigate the transient performance of Gene-set during motor starting, the mathematical models of exciter, governor, and load is considered in this study as given in appendix. The transient and subtransient reactances of the generator and motor are considered in the computer simulation so that more accurate results can be obtained.

The gene-set's ability to start large motors without large voltage and frequency dips depends on the entire system. System factors that affect generator operating characteristic during motor starting include:

- Available engine power;
- Capacity of the generator;
- Energy stored in the rotating inertia of the gene-set;
- Impedance of power distribution systems;
- Electrical design parameters of the motor;
- Acceleration of the motor and its load (motor characteristics);
- Motor terminal voltage.

A properly sized generator supports the high starting kVA (kVA_S) required and sustain adequate output voltage for the motor so it can produce the required torque to accelerate its load to rated speed. After the initial voltage dip, it is important that the generator restore voltage to at least 90% to develop adequate torque to accelerate its load to rated speed [9]. The

induction motor parameters considered in study are depicted in Table IV of appendix.

A. DOL Starting of IM on Gene-Set: Case Study

Emergency loads are usually served by on-side generation of limited capacity, which generally magnify voltage drop problem on motor starting, especially when large motors are involved. The DOL motor starting analysis is performed to investigate generator performance, induction motor performance and the performance of other connected load. The motor starting study can expose and identify the extent of a voltage drop problem [10]. The case study is performed with the help of ETAP software.

The case study is executed for 0.415kV motor control centre (MCC-402) in OST power distribution system. The fire water pump motor rated at 110kW is connected to MCC-402 as shown in SLD Fig. 1. Motor starting analysis is done when the entire load supplied by the gene-set is already in operation. The summary of the load flow results are given in the Table II.

Design parameters of induction motor are given in appendix. Motor starting current and the moment of inertia of motor and load is taken according to motor data sheet. The 110kW motor (PM-026A) is connected to MCC-402 by 400m long cable. The simulation results during DOL starting of 110kW induction motor, starting current, MCC-402 and motor terminal voltage, slip, motor and load torque are shown in Figs 3-6 respectively.

Voltage difference between voltage at motor terminal and the MCC-402 is due to voltage drop in the cable. Allowable voltage drop in the cable during normal operation is 3% and 15% during starting time. The motor terminal voltage during starting is 84.07% and then recovers slowly and stabilized at the post starting value of 93.39%. The percentage is based on nominal bus voltage.

Available Voltage at different buses as percentage of bus nominal kV and time duration throughout DOL motor starting is shown in Table III

TABLE II
LOAD FLOW RESULTS

Bus ID	Nominal kV	Operating kV (in %)
EPCC-401	0.415	96.87
MCC-401	0.415	96.5
MCC-402	0.415	95.81
PMCC-402A	0.415	95.73
MPCC-402B	0.415	95.68
SG-403	0.415	95.81
PM-026A	0.415	94.54

TABLE III
VOLTAGE DIP DURING MOTOR STARTING

Device ID	Rated voltage	% Voltage Operation	Duration (sec)
PM-026B	0.415	84.2	11.18
EPCC-401	0.415	93.3	11.02
MCC-401	0.415	92.8	11.16
MCC-402	0.415	90.5	11.26
PMCC-402A	0.415	92.2	11.24
PMCC-402B	0.415	92.2	11.24
SG-403	0.415	92.3	11.22

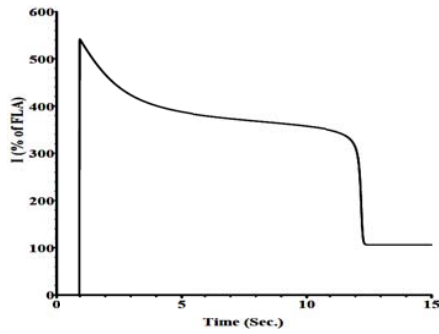

Fig. 3 Motor starting current variation with time

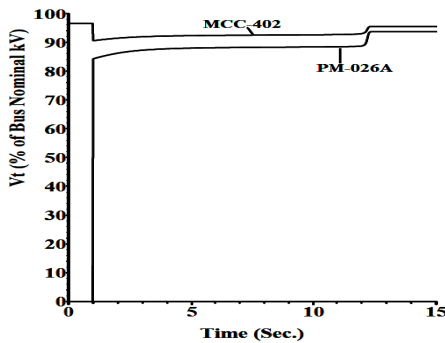

Fig. 4 Motor terminal and MCC-402 voltage in % wrt bus nominal voltage

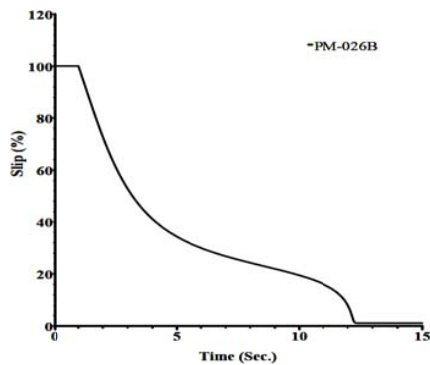

Fig 5 Motor slip during motor starting

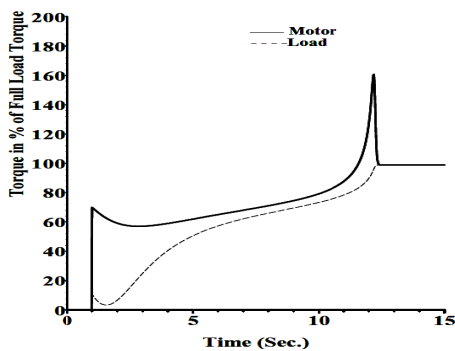

Fig. 6 Motor and Load torques during motor starting

B. Generator Power and PF during DOL IM starting

The power drawn by the induction motor during starting is mainly reactive due to the low power factor at the time of starting. Power output of the generator during the motor starting is shown Fig. 7.

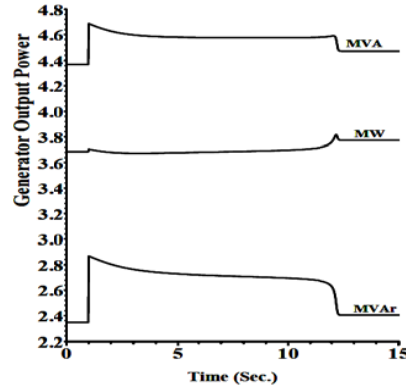

Fig. 7 Generator output power variation during motor starting

During motor starting, lower power factor demands higher excitation currents and results in increased losses. Generator power factor during motor starting is shown in Fig. 8. Over sizing A.C. generators for operation at lower power factors results in lower operating efficiency and higher costs.

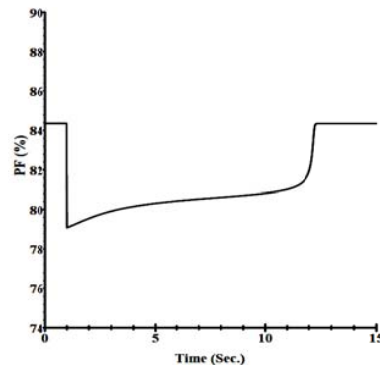

Fig. 8 Generator power factor variation during motor starting

V. CONCLUSION

The dynamic behavior of gene-set unit during direct-on-line starting of induction motors is interesting in grid isolated system. It is concluded from above results the gene-set is capable of supplying both steady state and transient loads without exceeding its designed frame overload capacity or producing a dangerously depressed voltage. Generator sizing typically depends on the permissible percentage of voltage and frequency dip and the acceptable duration of the voltage and frequency dip recovery time. Generator rating also depends on the percent of load step and type of load connected to the generator. Based on the given results it is clear generator gives good starting performance in terms of lowest voltage fluctuation. Accordingly, it is concluded from results obtained by motor starting analysis that the motor can DOL started

satisfactorily. This paper can be used as a design guide for generator selection. Motor starting study on gene-set must be performed at the design stage. If the system shows motor starting difficulty due to excessive voltage drop in the system, a new system configuration should be chosen to avoid the problem. Considering both the cost and performance of a standalone gene-set system should be carefully evaluated to select appropriate size during the design stage.

APPENDIX

A.IEEE Type 1 - Continuously Acting Regulator and Exciter

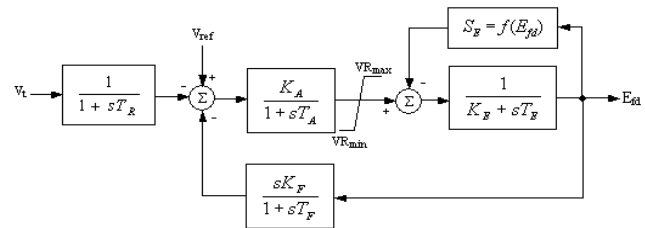

Fig. 9 Exciter block diagram

TABLE IV
INDUCTION MOTOR DATA

kW	kV	Full Load Current	P.F.	LRC in % of full load current	Starting P.F.	LRT in % of full load torque	Max. Torque in % of full load torque	X/R	H
110	0.415	179	0.88	600	0.25	98.69	199	11.1	0.92

TABLE V
GENERATOR DATA

kVA	kV	P.F.	H	X_l	X_d''	X_d'	X_d	X_q''	X_q'	X_q	T_{do}''	T_{do}'	T_{do}
5000	6.6	0.85	2.4	0.11	0.12	0.23	1.1	0.12	0.15	1.08	0.002	5.6	0.002

REFERENCE

- [1] IEEE Recommended Practice for Industrial and Commercial Power Systems Analysis, IEEE Std 399-1997, vol., no., pp.I, 1998
- [2] IEC 60034-12:1980, "Rotating electrical machines" Part 12: Starting performance of single speed three-phase cage induction motors for voltages up to and including 660 V
- [3] Rotating electrical machines – Part 1: Rating and performance, IEC 60034-1, 1999-08.
- [4] IEEE Recommended Practice for Protection and Coordination of Industrial and Commercial Power Systems," ANSI/IEEE Std 242-1986, vol., no., pp.0_1, 1986.
- [5] A. Jack Williams, M. Shan Griffith, "Evaluating the Effects of Motor Starting on Industrial and Commercial Power Systems," Industry Applications, IEEE Transactions on, vol.IA-14, no.4, pp.292-305, July 1978.
- [6] P.S. Patil, K.B. Porate, "Starting Analysis of Induction Motor: A Computer Simulation by ETAP Power Station," Emerging Trends in Engineering and Technology (ICETET), 2009 2nd International Conference on, vol., no., pp.494-499, 16-18 Dec. 2009
- [7] IEEE Recommended Practice for Electric Power Distribution for Industrial Plants" IEEE Std 141-1993.
- [8] Liang Xiaodong, O. Ilochonwu, "Induction Motor Starting in Practical Industrial Applications," Industry Applications, IEEE Transactions on, vol.47, no.1, pp.271-280, Jan.-Feb. 2011
- [9] John H. Stout "Capacitor Starting Of Large Motors " IEEE Transactions On Industry Applications, Vol. Ia-14, No. 3, May/June 1978, pp. 209-212
- [10] A. Jack Williams, JR. Member, M. Shan Griffith, "Evaluating the Effects of Motor Starting on Industrial and Commercial Power Systems" IEEE Transactions On Industry Applications, Vol. IA-14, NO. 4, JULY/AUGUST 1978

respectively. She is currently working as a professor in the Department of Electrical Engineering, MANIT, Bhopal, India. She has 12 research papers in International journals, 20 research papers in National journals, 22 research papers in International Conferences and 70 research papers in National Conferences. Her fields of interest are Power System Planning, Power Transmission Pricing, Power System Analysis and Deregulation. Dr. Agnihotri has a membership of Fellow IE (I) and LISTE.

Mukesh Kumar Kirar was born in Narsinghpur, India, in 06 Feb 1983. He received the B.E. (Electrical) degree from Government Engg. College, Ujjain, India in 2006 and M.Tech. (Power System) in 2008 and pursuing Ph.D from MANIT Bhopal, India. He is currently working as an assistant professor in the Department of Electrical Engineering, MANIT, Bhopal, India. His field of interests are power system stability and control, transformers and machines.

Ganga Agnihotri was born in Sagar, India, in 27 May 1949. She received the B.E. (Electrical) degree from MACT, Bhopal, India. She received the M.E. (Advance Electrical Machine) and PhD (Power System Planning Operation and Control) from University Of Roorkee, Roorkee in 1974 and 1989