

Efficiency Improvement of Wireless Power Transmission for Bio-Implanted Devices

Saad Mutashar, M. A. Hannan, S. A. Samad, A. Hussain

Abstract—This paper deals with the modified wireless power transmission system for biomedical implanted devices. The system consists of efficient class-E power amplifier and inductive power links based on spiral circular transmitter and receiver coils. The model of the class-E power amplifier operated with 13.56 MHz is designed, discussed and analyzed in which it is achieved 87.2% of efficiency. The inductive coupling method is used to achieve link efficiency up to 73% depending on the electronic remote system resistance. The improved system powered with 3.3 DC supply and the voltage across the transmitter side is 40 V whereas, cross the receiver side is 12 V which is rectified to meet the implanted micro-system circuit requirements. The system designed and simulated by NI MULTISIM 11.02.

Keywords—Wireless Transmission, inductive coupling, implanted devices, class-E power amplifier, coils design.

I. INTRODUCTION

THE powering method of the implanted biomedical devices is the major issue in the designing. In recent decades, a couple of weirs penetrates tissue is used to power the implanted devices, and these cases skin infections and hazard. Implanted batteries were used instead of weirs; the limited time-life of the battery, Make surgical interference to replace it from time to time faces the patient's life at risk [1]. Now days, the inductive coupling method is the major method used to power the implanted devices [2]. For example, the implanted cochlear for deaf people [3], retinal implant for bland people [4], and implanted micro-system used to stimulate and monitoring nerves and muscle activities [5].

A substitute is inductive links, which are coupled coils form an air core transformer [6]-[9]. As diagrammed in Fig. 1, an inductive link consists of two parts of electronics. Those located on the external or physically connected from the subjects are referred as primary side electronics or (external part), e.g., External battery, power transmitter, etc. Those located under the layers of biological tissue (implanted remote electronics) or along with the subjects (wearable electronics)

Saad Mutashar is a PhD candidate with the Department of Electrical, Electronic & Systems Engineering, Faculty of Engineering and Built Environment, University Kebangsaan Malaysia, 43600 UKM Bangi Selangor, Malaysia; and he is a lecturer at university of Technology-Baghdad Iraq (e-mail: saad_ra25@yahoo.com).

M. A. Hannan is with the Department of Electrical, Electronic & Systems Engineering, Faculty of Engineering and Built Environment, University Kebangsaan Malaysia, 43600 UKM Bangi Selangor, Malaysia (phone+60-3-8921-7014; Fax: +60-3-8921-6146; e-mail: hannan@eng.ukm.my).

A. S. Salina and A. Hussain with the Department of Electrical, Electronic & Systems Engineering, Faculty University Kebangsaan Malaysia, 43600 UKM Bangi Selangor, Malaysia (e-mail: salina@eng.ukm.my; aini@eng.ukm.my).

are referred as secondary electronics or (internal part), the internal part powered inductively from the external part and consists of rectifier, power recovery circuits such as regulators, and power management units. Power-transmission efficiency and system smallness are major design specifications to evaluate a power link. Given application related constraints, these specifications are inherently correlated and a careful trade-off analysis is required to achieve an optimal performance. One of the main disadvantages of the inductive coupling method is the weak coupling, and to overcome this problem, the power amplifier elements and parasitic elements of the inductive coupling link should be carefully calculated.

In this paper, 13.56 MHz has been chosen as the carrier frequency, which is in the ISM band range to avoid the tissue damage. The efficient class-E power amplifier is designed, analyzed and simulated to achieve 87.2% of efficiency. The proposed inductive coupling link was simulated to achieve power link efficiency up to 73%. This structure may be suitable to use for implanted micro-system.

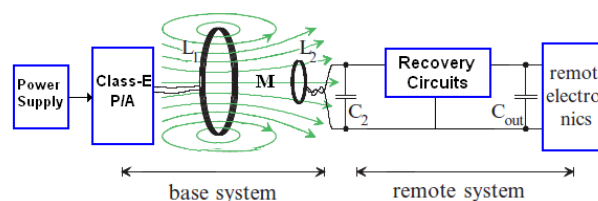

Fig. 1 Inductive power transmission block

II. CLASS-E POWER AMPLIFIER METHOD

Class-E power amplifiers, are an interesting compromise between a linear class-A, non-linear class-B power amplifiers and a switched power amplifiers. In general, class-E amplifier is widely used in implantable devices, and it is a more suitable power amplifier as an element driver for transmitter coil because of its high efficiency about 90-95% and produces a stable sinusoidal signal to drive the inductive link [10]. And when used as a modulator it eliminates the used for a mixer and this minimized the power consumption and overall size. Fig. 2 shows the simple class-E amplifier. Class-E consists of an inductor choke (L_{ch}) to reduce ripples and provide a constant current from the power supply V_{DD} , in additional has no series resistance. Class-E power amplifier structure is simple and sue single pole MOSFET transistor switch with a shunt capacitor C_2 used to remove harmonics and ensure zero-voltage switching of the non-ideal MOSFET switch. This capacitor connected in parallel with a series load network RLC

that is tuned to a certain frequency 13.56 MHz to achieve a constant current from the supply source and converts the digital input signal into a stable sinusoidal output with zero DC offset. The MOSFET transistor is used as a switch and driven by a periodic pulse, which is represented as a series of positive and negative step inputs.

The inductive coupling link L_1 will be used as a physical coil transmitter to transfer power to the implanted device through a magnetic coupling field [11]. The high efficiency of the class-E can be achieved by reducing the transistor switching losses. The transistor MOSFET turned ON when the drain voltage has come back to zero, reducing the turn ON loss zero voltage switching. The drain voltage is also raised from zero at the time of turning ON, which allows for slight returning without losing in the efficiency. The two states of the power amplifier are shown in Fig. 3, which explains the status waveforms of the voltage and the current in switching time. This activity of fast switching reduces the power consumption of the system and offers a stable sinusoidal wave to the inductive link with above 87.2% of efficiency.

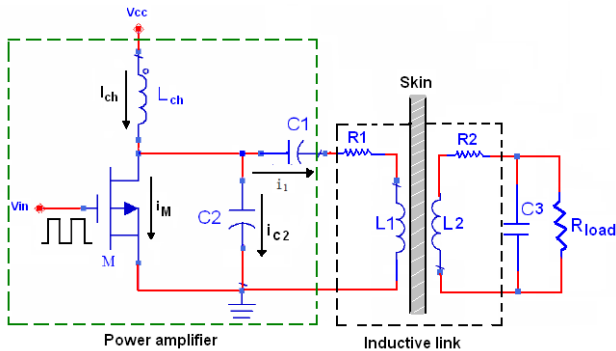

Fig. 2 Class-E power amplifier and inductive link blocks

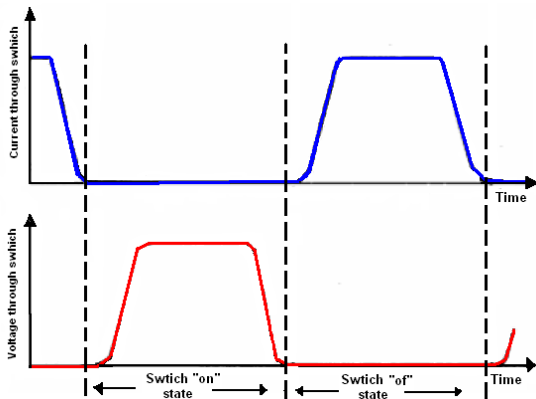

Fig. 3 Waveforms of the voltage and current switch conditions

III. MODEL DESIGN FOR CLASS-E AMPLIFIER AT 13.56 MHZ

To design optimum class-E power amplifier, many factors should be considered. The components such as L_{ch} , C_1 , C_2 , L_1 and the switch transistor CMOS should be chosen to achieve high speed of switching hence, the transistor (2N7000 MOSFET) is chosen to be use in our design due to its fast

switching. As shown in Fig. 3, the power transmission system operated with 13.56 MHz and powered with 3.3 DC V, the system consists of two parts, the first part is the class-E amplifier. The duty cycle is 50%, and is turned on time $(2n+1)\pi$. I_{ch} is the DC current across L_{ch} , where “ i ” represent the current in the resonant tank and is expressed as

$$i_1 = I_1 \sin ((\omega t + \Phi))$$

where

$$\Phi = -32.5^\circ$$

Then

$$\frac{I_1}{I_{ch}} = \left(\frac{\pi^2}{4} + 1\right)^{\frac{1}{2}} \tag{1}$$

And the peak voltage across the CMOS switch (V_{peak}) appear

$$\text{when } d_{vc2}(t)/dt = 0, \text{ where } V_{peak} \approx -2\pi\Phi V_{ch}$$

The values of the components calculated as follows:

$$C_2 = \frac{1}{\omega_0 R_1 \left[\frac{\pi^2}{4} + 1\right] \left[\frac{\pi}{2}\right]} = \frac{1}{\omega_0 (5.447 R_1)} \tag{2}$$

$$L_1 = \frac{Q R_1}{\omega_0} \tag{3}$$

$$C_1 = C_2 \left[\frac{5.447}{Q}\right] \left[1 + \frac{1.42}{Q - 2.08}\right] \tag{4}$$

In the inductive coupling power, the resistor is very small and depending of the coils, secondary coil load and coupling link [12]. Therefore, in our work the chosen operated frequency is 13.56 MHz and the resistor $R_1 = 2.2 \Omega$. For maximum efficiency we must chose the maximum quality factor (Q) must be reliable with the required bandwidth, and taking into account that a high Q -factor of the inductive coil should make the output as close to an ideal sinusoidal as possible, and the very high Q factor reduces the effective bandwidth of the system [13]. Therefore, the choice of the parameter Q factor must be sensible according to (5).

$$Q \leq \frac{\omega_0 L}{R} \tag{5}$$

In this work, the Q -factor for the series resonance branch (C_1 , L_1 and R_1) stated in Fig. 2 is assumed 10.

Inserting above values in (2)-(4) then, the class-E values will be $C_2 = 51.5$ PF, $C_1 = 33.11$ PF, $L_1 = 4.92 \mu\text{H}$. The proposed class-E design achieves 87.2% of efficiency. Fig. 4 shows the performance of the class-E power amplifier. The output and the drain-source voltage V_{DS} , equal to zero when the switch is active state “1” and gain-source voltage V_{GS} , equal to zero when the switch in state “0”. This activity and fast switching reduce the power consumption of the system and provides a stable sinusoidal wave to the inductive link with above 87.2% of efficiency.

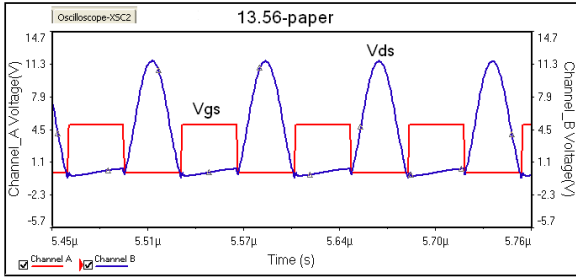

Fig. 4 Class-E performance, drain-source and gate-source in time

IV. INDUCTIVE POWER LINK

Currently, the inductive coupling link methods are widely used in biomedical applications, and because of weak coupling, this method still in constant evolution to overcome coupling weakness. In this paper, the inductive links based on circular coils was proposed to achieve link efficiency up to 73%. Fig. 2 illustrates the inductive power link with transmitted and received inductors L_1 and L_2 , which tuned at the same resonant frequency. The resistors R_1 and R_2 are the equivalent series resistance (ESR) of inductor L_1 and L_2 . R_{load} represents equivalent AC load resistance, which is half of its DC counterpart. C_3 is a summation of parasitic capacity and parallel capacity of the primary side. The coupling coefficient K value between transmitting and receiving coil is 0.087, which calculated from coil optimization design for our previous work [14]. The total power efficiency $\eta_{1,2}$ is the multiplication of the secondary part efficiency η_1 and primary coil. Q_1 and Q_2 are the quality factors of external and internal coils, respectively as given in (6);

$$Q_1 = \frac{\omega_0 L_1}{R_1} \text{ and } Q_2 = \frac{\omega_0 L_2}{R_2} \quad (6)$$

We have been omitted and only the final equations of the total efficiency as given in (7).

$$\eta_{link} = \eta_1 * \eta_2 = \frac{K^2 Q_1 Q_2^3 R_2 R_{load}}{(K^2 Q_1 Q_2^3 R_2 R_{load} + K^2 Q_1 Q_2 R_{load}^2 + Q_2^2 R_2^2 + 2Q_2^2 R_2 R_{load} + R_{load}^2)} \quad (7)$$

The load resistance $R_{load} \geq 2\omega L_2$ hence, we assumed that, R_{load} is between 200 Ω to 400 Ω depending on implanted electronic remote resistance. The power link efficiency calculated using Matlab is up to 73%, the voltage on the primary coil is 40 V and on secondary coil is 12 V, then this voltage rectified to 4 V which meet the implanted micro-system requirements.

V. RESULTS AND DISCUSSIONS

The wireless power transmission consists of two parts, power amplifier and inductive coupling and plays an important role in reducing the implanted devices power consumption. Therefore, both parts should be carefully design. The first part is the class-E power amplifier, which is widely used in biomedical applications due to its simplest and high efficiency. The high class-E efficiency can achieve by reducing the transistor (switching) loss. To overcome this

problem, the class-E elements must be chosen and carefully calculated. The CMOS transistor was chosen due to its fast switching, the values of the components C_2 , C_1 and L_1 are calculated to satisfy the transistor switching. Simulation and results in Fig. 4 shows the Drain-Source voltage ($V_{DS} = 0$) when the switch is an active state (1) and vice-versa. This model has an efficiency 87.2% and offers very stable sinusoidal signal to drive the inductive link where the voltage indicated on the transmitter conductor L_1 is 40 V as shown in Fig. 5.

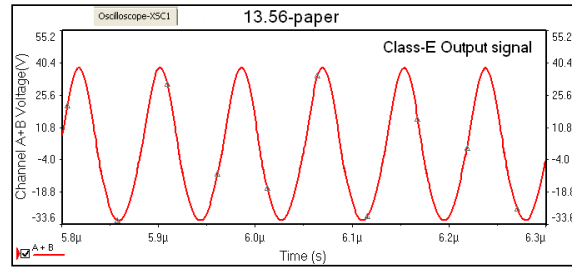

Fig. 5 The class-E output signal

The second part is the inductive coupling. One of the main inductive coupling disadvantages is the weak coupling. To overcome this disadvantage, the inductors shape and size should be considered. These inductors act as a transmitter and receiver. The inductor geometric given in our work [14] is used in this work, and according to the coils radius the coupling coefficient is ($K = 0.087$). Both coils tuned at the same resonance frequency 13.56 MHz as shown in Fig. 6. The voltage on the transmitter side is 40 V, and the voltage at the receiver is 12 V as shown in Fig. 7, the 12 V is rectified to 4 V to meet the implanted micro-system requirements. Assuming that, R_{load} is between 200 Ω to 400 Ω which is presents the implanted electronic remote resistance, and the coupling coefficient (0.01 to 0.1). Inserting the values in (8), the power link efficiency calculated using Matlab is up to 73% as shown in Fig. 8.

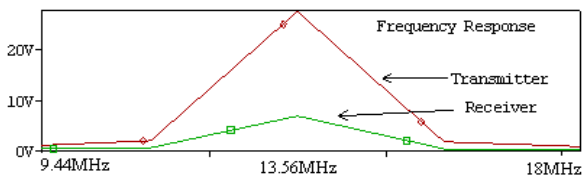

Fig. 6 Both coils tuned at the same resonant frequency

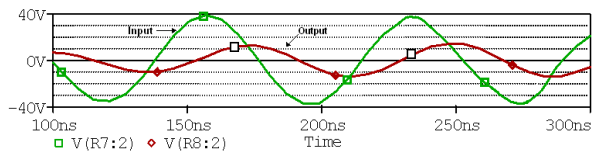

Fig. 7 Voltage indicated on the transmitter and receiver coils

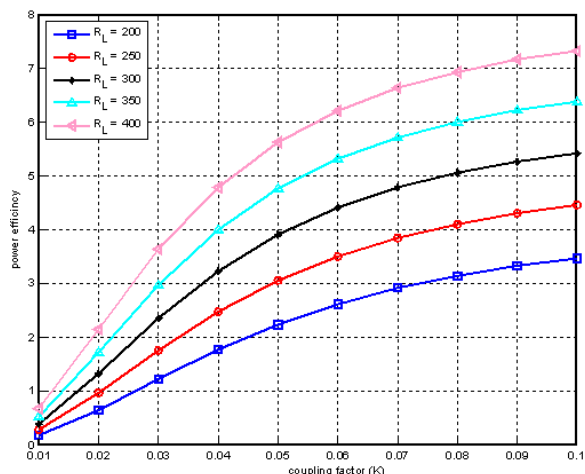

Fig. 8 Power efficiency links with various resistance and coupling coefficients

VI. CONCLUSION

This paper developed an improvement of wireless power transmission system used to power the bio-implanted devices. The system designed and simulated by NI-MULTISIM 11.02 software and consists of two parts, class-E power amplifier and inductive coupling link. The power amplifier efficiency is 87.2%, powered with 3.3 DC V, and operated frequency 13.56 MHz to produce a stable sinusoidal signal to drive the inductive coupling link based on spiral circular coils. The voltage indicated on the transmitter coil is 40 V and on the receiver coil is 12 V. The voltage on the receiver side rectified to 4 V to meet the bio-implanted micro system. The power link efficiency is 73%.

REFERENCES

- [1] M. A. Hannan, S. M. Abbas, S. A. Samad and A. Hussain, "Modulation Techniques for Biomedical Implanted Devices and Their Challenges," *sensor*. Vol. 12, pp. 297-319. 2012.
- [2] Z. Hamici, R. Itti and J. Champier, "A high-efficiency power and data transmission system for biomedical implanted electronic devices," *Measurement Science and Technology*. Vol. 7. No. 2, pp. 192-201. 1996.
- [3] J. Wang, M. Gulari, K.D. Wise, "An integrated position sensing system for a MEMS-based cochlear implant," *Electron Devices Meeting. IEDM Technical Digest, IEEE International conference*, 2005, pp. 121-124.
- [4] W. Liu, K. Vichienchom, M. Clements, S.C. De Marco, C. Hughes, E. Mcucken, M.S. Humayun, E. De Juan, J.D. Weiland and R. Greenberg, "A neuro-stimulus chip with telemetry unit for retinal prosthetic device," *IEEE Journal of Solid-State Circuits*, , Vol. 35, No.10, pp. 1487-1497. 2000.
- [5] S. Mutashar, M. A. Hannan, A. S. Salina, and Aini Hussain, "Efficient data and power transfer for bio-implanted devices based on ASK modulation techniques," *Journal of Mechanics in Medicine and Biology (JMMEB)*. Vol. 12. No. 5. 2012.
- [6] W. Li, D. Rodger, J. Weiland, M. Humayun, and Y. Tai, "Integrated flexible ocular coil for power and data transfer in retinal prostheses," *International Conference of the Engineering in Medicine and Biology Society (EMBS)*, 2005, pp. 1028-1031.
- [7] C. Sauer, M. Stanacevic, G. Cauwenberghs and N. Thakor, "Power harvesting and telemetry in CMOS for implanted devices," *IEEE Transactions on Circuits and Systems I*. Vol. 52, no. 12, pp. 2605-2613. 2005.
- [8] M. Sivaprakasam, W. Liu, M. Humayun and J. Weiland, "A variable range bi-phasic current stimulus driver circuitry for an implantable retinal prosthetic device," *IEEE Journal of Solid-State Circuits*. Vol. 40, no. 3, pp. 763-771. 2005.
- [9] G. Wang, W. Liu, M. Sivaprakasam, and G. Kendir, "Design and analysis of an adaptive transcutaneous power telemetry for biomedical implants," *IEEE Transactions on Circuits and Systems I: Regular Papers*. Vol.52, no. 10, pp. 2109-2117. 2005.
- [10] N. O. Sokal, A. D. Sokal, "Class-E a new class of high efficiency tuned single-ended Switching power amplifiers," *IEEE Journal of Solid-state circuit*, vol. 10, pp.168-176, Jun 1975.
- [11] S. Mutashar, M. A. Hannan and A. S. Salina, "Efficient Class-E Design for Inductive Powering Wireless Biotelemetry Applications," *IEEE International Conference on Biomedical Engineering (ICoBE)*, 27-28 February 2012. P.p 445-449. Perlis. Malaysia.
- [12] N. Furqan, D. Maeve, "Amplifier design for a biomedical inductive power system," *IEEE 21st international conference on signals and systems*. Jun 2010. pp. 169-174, Cork Ireland.
- [13] B. Lenaerts, R. Puers, "Omnidirectional inductive powering for biomedical implants," (Analog circuits and signal processing) *Springer* 2008.
- [14] S. M. Abbas, M. A. Hannan, S. A. Samad and A. Hussain, "Designing Transcutaneous Inductive Powering Links for Implanted Micro-System Device," *World Academy of Science, Engineering and Technology. International Conference on Bioinformatics, Computational Biology and Biomedical Engineering* 6-7 December 2012. Vol, 72. Pp. 223-228. Perth Australia.