

# Effect of Various Nozzle Profiles on Performance of a Two Phase Flow Jet Pump

Vishnu Prasad Sharma, S. Kumaraswamy, and A. Mani

**Abstract**—This paper reports on the results of experimental investigations on the performance of a jet pump operated under selected primary flows to optimize the related parameters. For this purpose a two-phase flow jet pump was used employing various profiles of nozzles as the primary device which was designed, fabricated and used along with the combination of mixing tube and diffuser. The profiles employed were circular, conical, and elliptical. The diameter of the nozzle used was 4 mm. The area ratio of the jet pump was 0.16. The test facility created for this purpose was an open loop continuous circulation system. Performance of the jet pump was obtained as iso-efficiency curves on characteristic curves drawn for various water flow rates. To perform the suction capability, evacuation test was conducted at best efficiency point for all the profiles.

**Keywords**—Evacuation test, jet pump, nozzle profile, nozzle spacing, performance test, two phase flow

## I. INTRODUCTION

THE jet pump transfers momentum and energy from a high velocity jet to a secondary fluid. The good sealing possibilities and the absence of moving parts are the merits of jet pump. Jet pumps are widely used because of their high reliability where efficiency is of secondary importance, particularly in remote or inaccessible locations, such as for flash desalination systems to create a vacuum inside the flash chamber, pumping corrosive or erosive mixtures where air may be present in the suction line, and the offset- installation which is a unique feature of jet pump. To evaluate the performance, a two-phase flow jet pump was tested. Water from an open tank was pressurized by a multistage horizontal axis centrifugal pump having variable frequency drive. As high pressure motive fluid was supplied through the nozzle, pressure energy was converted into kinetic energy. This flow then combined with the low velocity suction fluid reaching the suction chamber of 50 mm diameter by turbulent mixing in the mixing tube of the pump. The diameter and length of mixing tube were 10 mm and 262 mm respectively. In order to convert partly the velocity head into pressure head, this resultant flow was further delivered through a diffuser.

Vishnu Prasad Sharma is with the Department of Mechanical Engineering, Indian Institute of Technology Madras, Chennai 600 036, India; e-mail: sharmavishnu.iitm@yahoo.com

S. Kumaraswamy is with the Department of Mechanical Engineering, Indian Institute of Technology Madras, Chennai 600 036, India (corresponding author to provide phone: +91-44-2257 4663; fax: +91-44-2257 4652; e-mail: kumars@iitm.ac.in)

A. Mani is with the Department of Mechanical Engineering, Indian Institute of Technology Madras, Chennai 600 036, India; e-mail: mania@iitm.ac.in

The design of a liquid jet air pump to provide maximum efficiency requires not only a correct mixing tube length but also an optimum nozzle to mixing tube spacing. The experimental investigation led to determination of the effect of various nozzle profiles, distance between the driving nozzle exit to mixing tube entrance (S), the suction rate, etc. For testing the above, the supply tube with nozzle was moved axially inside the jet pump from  $S = 28$  to 36 mm. Other parameters such as nozzle diameter, mixing tube length, diffuser length, diffuser angle, etc., were held constant. Performance of the jet pump at three nozzle distances was studied. Iso-efficiency curve was obtained on performance curves for the best combination with reference to nozzle profile and nozzle to mixing tube spacing (S). With the help of these characteristic curves, it is possible to locate the point of best performance of the jet pump.

## II. LITERATURE SURVEY

[1] reported the experimental flow conditions in the jet pump for its performance and the results corresponded to the limited region. His experiments indicated that secondary flow rate was not dependent of the pressure ratio. The experimental evidence showed the need for a correct analysis of pumping action. [2] investigated the type of flow in jet pump and included additional restrictions. Their solutions showed that secondary air flow rate increased as primary water flow rate or upstream pressure of the jet pump was increased, and that secondary air flow rate was a function of ratio of pressures of secondary air and outlet of the jet pump when outlet pressure of the pump was a constant. [3]- [4] was the first to plan liquid jet gas (LJG) pump tests. He showed the flow processes in the throat and called it as "mixing shock". Experimentally he demonstrated high volumetric entrainment ratios and accompanying high isothermal compression efficiencies, up to 40%, by means of multihole nozzles, and a relatively long mixing throat. [5] improved the analysis, particularly for the diffuser. He demonstrated good agreement between theory and experiment, provided the mixing zone remained in the mixing tube. Design refinements – particularly mixing tube lengths up to 23 diameters resulted in isothermal efficiencies as high as 19%. [6] made an important contribution in reporting tests with a transparent mixing tube: best performance was obtained when the mixing zone was positioned in the cylindrical mixing tube section. [7] presented the performance of various flow obstruction devices and reported that the one with orifice gives maximum efficiency for maximum flow rate. [8], studied about the entrainment and mixing process of an ejector which works on the principle of a main jet entraining and driving the

secondary air to the mixing chamber. The work was an experimental investigation for determining the entrainment characteristics of the axi-symmetric jet kept at distances of various nozzle diameters from the start of the mixing chamber. Experiments were conducted with various diameter ratios of the nozzle to the chamber for estimating the optimum entrainment rate. They concluded that at higher Reynolds number, the entrainment rate was independent of Reynolds number. Schmitt [9] presented one dimensional relations for the LJM pump and compared experimental results with theory. He also tested pumps with transparent-mixing tubes. With a fixed water jet velocity and suction port air pressure, he found that the mixing zone could be positioned at will by controlling the back-pressure. Optimum performance occurred when mixing was located just at the end of the mixing tube exit, i.e., at the diffuser entrance. A long (24-diameter) mixing tube produced efficiencies as high as 13%. He reviewed the various ejection and compression methods used for extraction, compression and mixing of fluids, and propulsion or lifting. He also used different techniques to design jet pumps and listed their performance. A method of designing of jet pump and selection of horizontal axis multi-stage centrifugal pump with variable frequency drive to provide high head motive fluid to jet pump was given by [11]. Experimental performance of a jet pump assisted vacuum desalination plant was given by [12] for a typical operating condition. Using various orifice spacings and orifice as an obstruction device the maximum efficiency realized was approximately 41% at a

higher value of water flow rate. To summarize the experimental results, both [3]-[4] and [6] have shown that isothermal efficiencies of 40% or better are possible with combinations of jet characteristics (nozzle design), mixing tube length and operating conditions.

### III. EXPERIMENTAL SETUP

The jet pump for this investigation consists of the following elements: primary water flow inlet with the primary nozzle, suction chamber with secondary air flow inlet, mixing tube and diffuser. Fig. 1 is showing the cross sectional representation of the two-phase jet pumps.

Considering the area ratio ( $A_r$ ) i.e. nozzle to mixing tube area ratio as 0.16 and other predefined parameters, primary nozzle was designed. Indian standard 'IS 14615' was adapted for this purpose. Nozzle was fabricated using a form tool. The profile measurement was done using optical profilometer. Deviation was found to be within acceptable limits.

Fig. 2 shows the sectional view of various nozzle profiles. All the dimensions are in millimeter. In order to achieve the uniformity on performance and making the distinct comparison with reference to the nozzle to mixing tube spacing ( $S$ ), the length of the straight portion in the nozzle was kept same for all the profiles. For present study, it is 2.4 mm as shown in fig. 2. Notches are meant for spanning arrangement across the flat surface. Table I shows the design details of this jet pump.

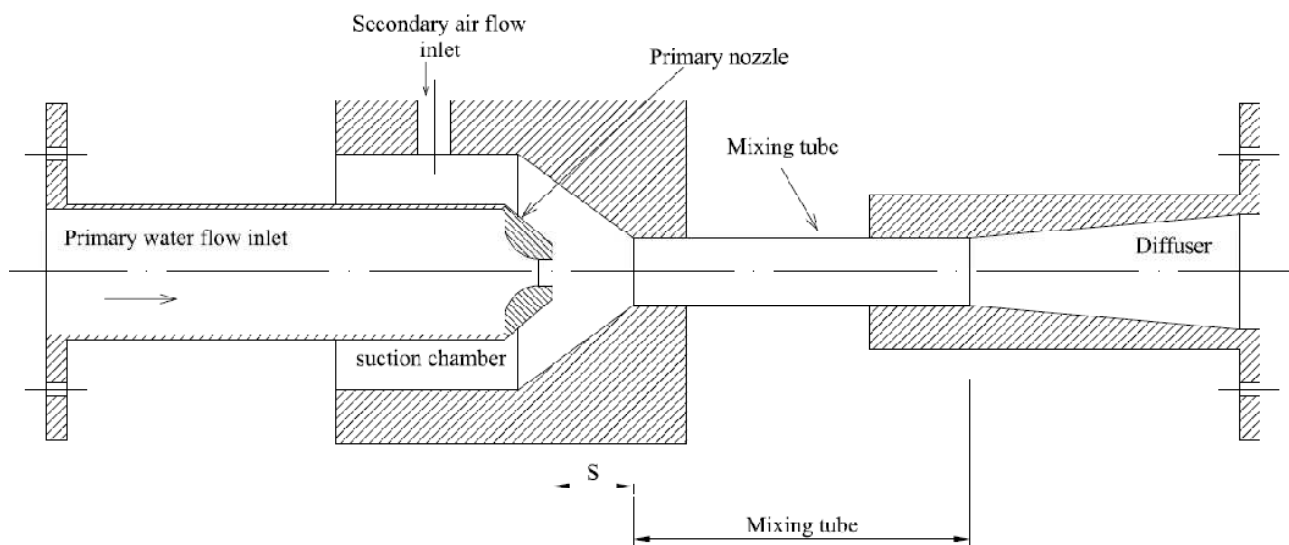

Fig. 1 Cross section of jet pump along with mixing tube and diffuser

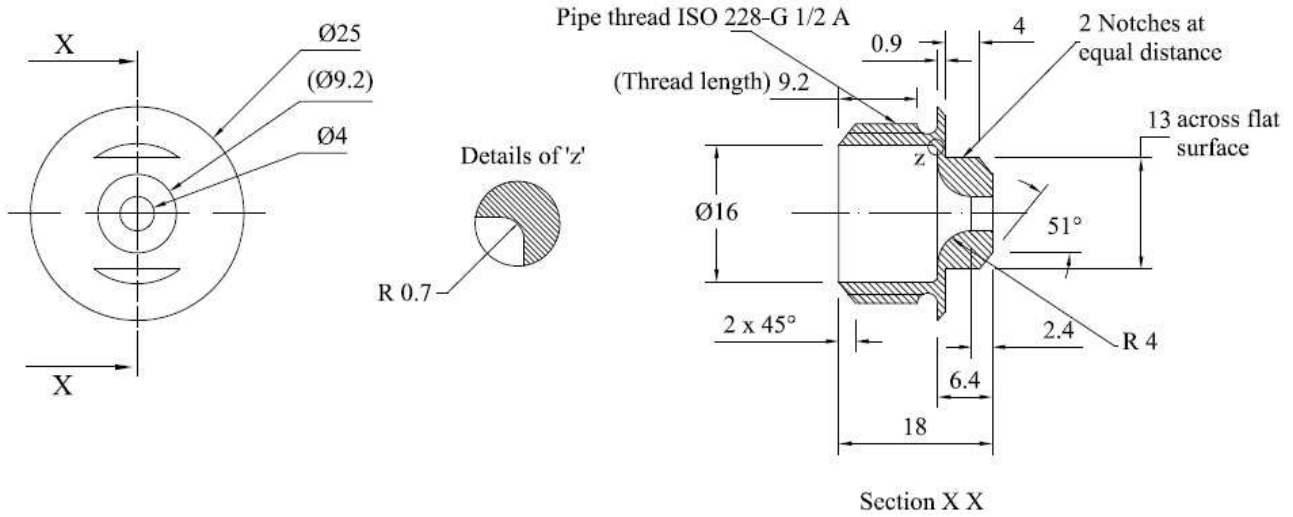

Fig. 2 (a) Sectional view of primary device with circular profile

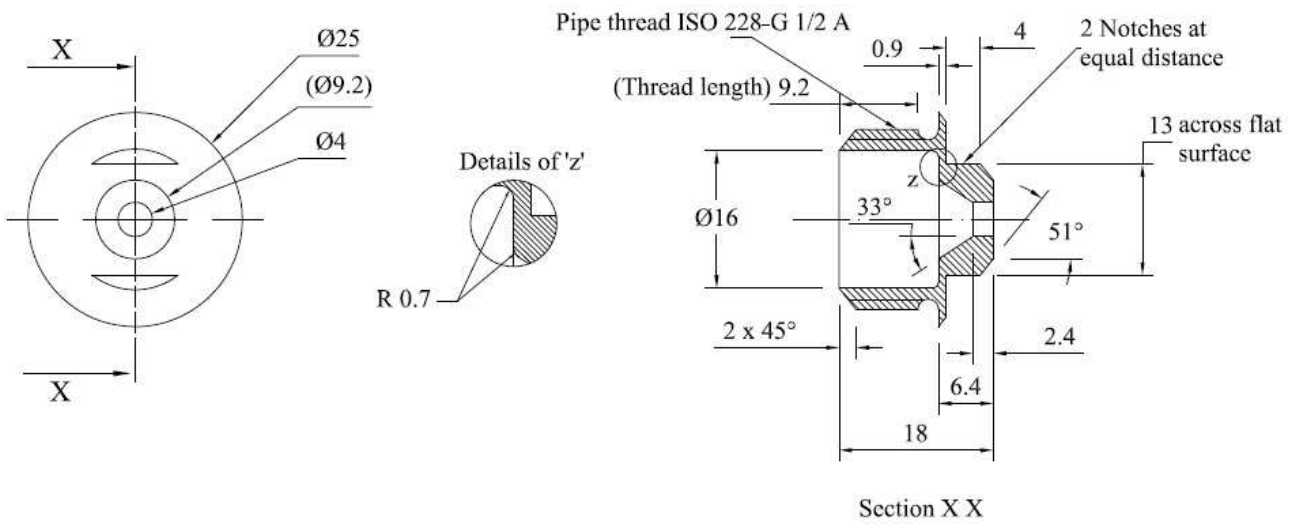

Fig. 2 (b) Sectional view of primary device with conical profile

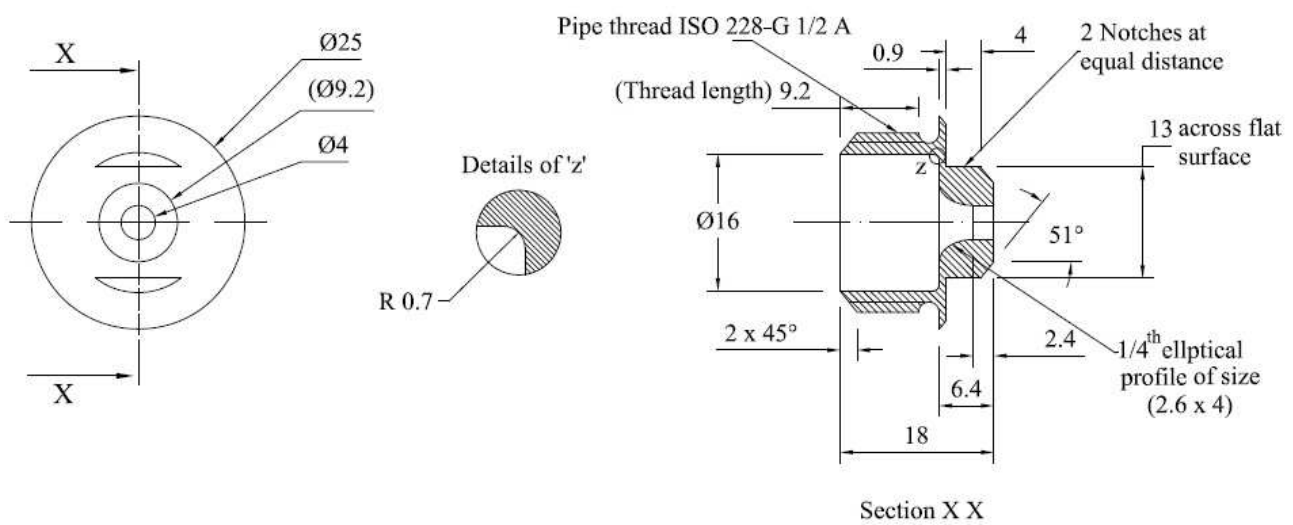

Fig. 2 (c) Sectional view of primary device with elliptical profile

TABLE I  
JET PUMP DIMENSIONS

| Parts Name   | Dimensions       |
|--|------------------|
| Nozzle diameter  | 4 mm             |
| Suction chamber diameter   | 50 mm            |
| Mixing tube diameter   | 10 mm            |
| Length of the mixing tube  | 262 mm           |
| Length of the diffuser   | 135 mm           |
| Diameter of the diffuser at outlet   | 21 mm            |
| Diffuser semi cone angle   | 2° 30'           |
| Length of jet pump   | 800 mm           |
| Distances between Nozzle exit and mixing tube entrance (S) used for the experiment | 28, 32 and 36 mm |

The test facility created for this purpose was an open loop, continuous circulation system. To have visual observations, the jet pump was fabricated from acrylic plastic. Fig. 3 shows the schematic diagram of the test rig. Water from an open tank is pressurized by a multi-stage horizontal axis centrifugal pump having a variable frequency drive and the high head water is supplied to jet pump nozzle as the motive fluid. Nozzle produces high velocity jet and creates vacuum in the suction chamber; hence, entrainment of secondary air from chamber takes place. Water and air mix thoroughly in the mixing tube. The diffuser converts energy of this mixture partially from kinetic to pressure. Then the mixture returns to water tank through the pipe line.

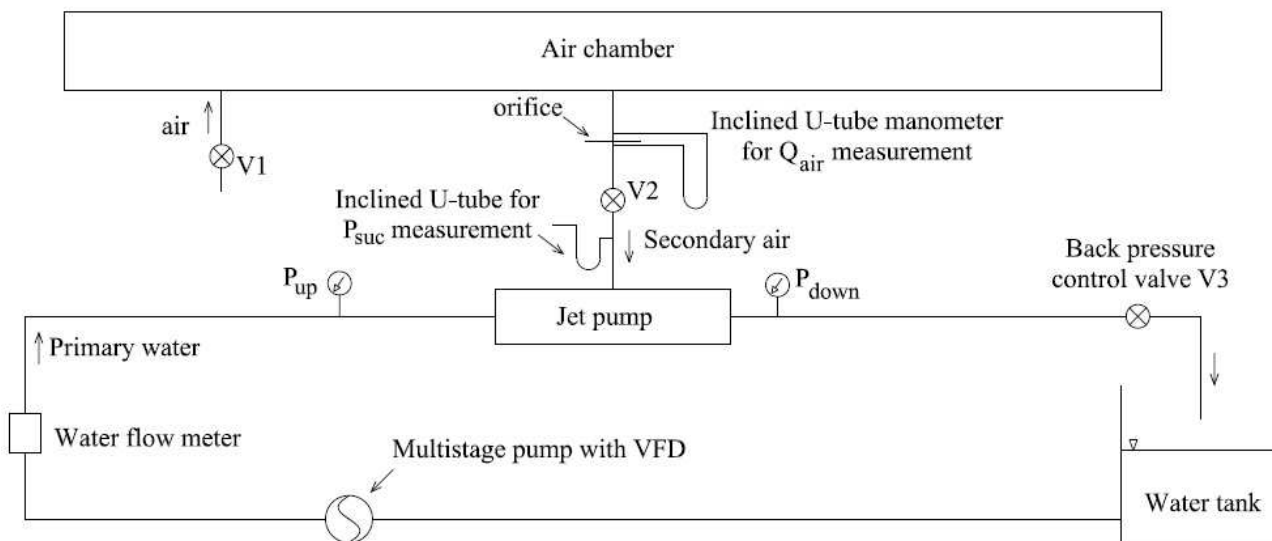

Fig. 3 Schematic arrangement of two phase flow jet pump test set up

#### IV. INSTRUMENTATION

The primary water flow rate ( $Q_w$ ) was measured with a wheel-type flow meter and the secondary air flow ( $Q_a$ ) with an orifice meter. Three pressures at upstream, suction and downstream side of the jet pump were measured. A precision bourdon-type pressure gauge was used for measuring upstream pressure ( $P_{up}$ ) of the jet pump. Secondary air pressure ( $P_{suc}$ ) at jet pump suction was measured by an inclined U-tube manometer where as pressure at downstream of the jet pump ( $P_{down}$ ) was measured by precision digital compound gauge. Pressure gauges, flow meter and orifice meter were calibrated adopting standard procedures. The instruments/sensors used for measurement of parameters, their range and accuracies are shown in Table II.

TABLE II  
RANGE OF MEASUREMENTS AND ACCURACIES

| Measurement parameters  | Instruments                               | Range         | Accuracy          |
|-------------------------|---|---------------|-------------------|
| Primary water flow rate | Wheel type flow meter                     | 0 -10,000 lph | $\pm 1$ lph       |
| Secondary air flow      | Orifice meter & inclined U-tube manometer | 0-500 mm      | $\pm 2$ mm        |
| Upstream water pressure | Bourdon pressure gauge                    | 0-25 bar      | $\pm 2\%$ of F.S. |
| Secondary air pressure  | Inclined U-tube manometer                 | 0-400 mm      | $\pm 2$ mm        |
| Downstream pressure     | Digital compound gauge                    | 0-4 bar       | $\pm 0.1\%$ F.S.  |

V. RESULTS AND DISCUSSION

A. Performance Test

Performance was obtained over a wide range of operating conditions for the jet pump. Nozzle profiles employed were circular, conical and elliptical. Test runs were conducted by closing the back pressure control valve V3 of the jet pump in discrete steps. Hence, flow ratio was varied by keeping the primary water flow rate constant. Valves V1 and V2 were always kept open for all operating conditions for these tests. This procedure was followed at three nozzle spacings for 28 mm, 32 mm and 36 mm. Using VFD and spacing shims, primary water flow rates and nozzle to mixing tube distances were varied for this study during the experiments. Experiments have been limited to a maximum of a primary flow rate of 0.444 lps because flow reversal was found when the jet pump was operated at a primary flow rate higher than 0.444 lps.

The minimum data required to assess performance are the two flow rates (primary and secondary), and three pressures (upstream, downstream and suction). Some dimensionless parameters for performance are characterized below:

$$\text{Flow ratio, } M = \frac{Q_a}{Q_w} \tag{1}$$

$$\text{Pressure ratio, } N = \frac{(P_{down} - P_{suc})}{(P_{up} - P_{down})} \tag{2}$$

$$\text{Efficiency, } \eta = \frac{Q_a (P_{down} - P_{suc})}{Q_w (P_{up} - P_{down})} = M \times N \tag{3}$$

Fig. 4 shows the overall performance of the jet pump with the elliptical profiled nozzle for a nozzle to mixing tube spacing of 32 mm, plotted as a function of pressure ratio vs. flow ratio for various primary water flow rates. The curves shown in figure were expected to coincide as one single curve irrespective of primary water flow rates. Since there is an appreciable deviation, in order to understand the real behavior and performance of the pump, the dimensional characteristics of the jet pump were plotted.

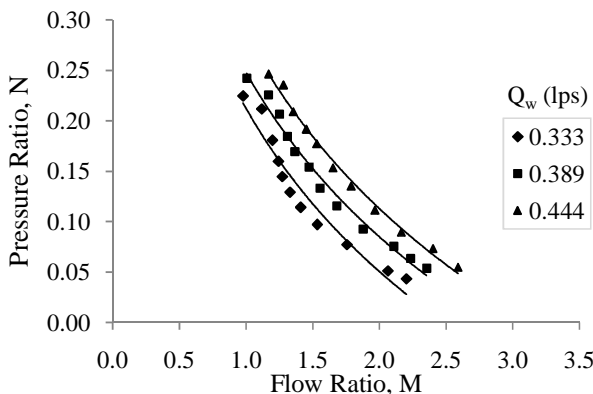

Fig. 4 Dimensionless plot for elliptical profiled nozzle at 32 mm of nozzle spacing

Fig. 5 discerns the dimensional characteristic of the jet pump. It was found that these dimensionalized curves form a pattern as the water flow rate is varied. It can be seen from fig.

5 that for a constant value of air flow rate ( $Q_a$ ), as the primary water flow rate ( $Q_w$ ) is increased, higher value of energy is added to the suction fluid. At the same time it can be seen that for a constant energy addition, air flow rate is decreasing proportionally with respect to primary water flow rate. This indicates that, higher water flow rates are needed in order to achieve higher suction flow rate and higher energy addition.

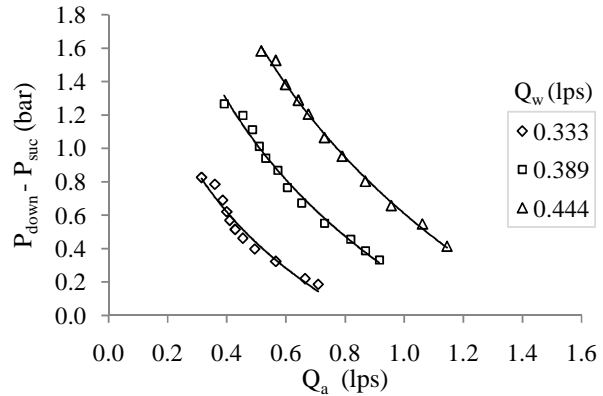

Fig. 5 Dimensional characteristic for elliptical profiled nozzle at 32 mm of nozzle spacing

Fig. 6 shows the comparison of various nozzle profiles as dimensionless characteristics drawn for the highest water flow rate at nozzle spacing of 32 mm. It was found that, for the circular and conical profile, characteristics were following almost the same pattern but a significant increment on energy addition was obtained with elliptical profile. This is possibly due to considering the fact of minimized losses for the elliptical profile.

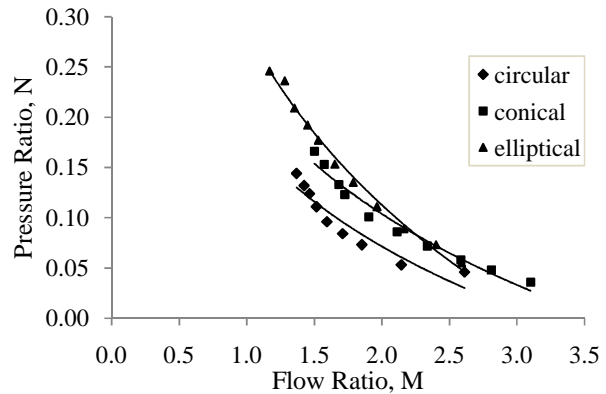

Fig. 6 Dimensionless plot showing the comparison at S = 32 mm &  $Q_w = 0.444$  lps

Considering the results shown in fig. 6, efficiency vs.  $Q_a$  curve was plotted as shown in fig. 7. Using the experimental values curves were drawn. These are not the trend line, but the best fitted curves drawn for various  $Q_a$  using the concept of curve fitting. It was observed that, generally efficiency was increasing with the increment of primary water flow rate ( $Q_w$ ). It indicates that, higher primary water flow rate encourages higher energy addition to the lower velocity suction fluid.

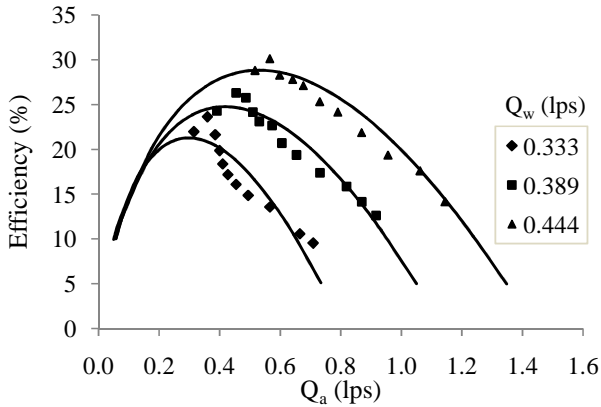

Fig. 7 Performance characteristics of the jet pump for elliptical profiled nozzle at 32 mm of nozzle spacing

As a result from fig. 7, performance curve was plotted for all the nozzle profiles at highest water flow rate as shown in fig. 8. Curves shown in fig. 8 conclude that the elliptical profile is best among all for the 4 mm diameter of nozzle.

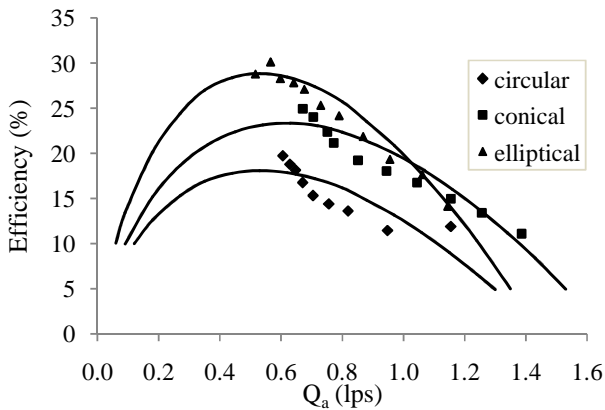

Fig. 8 Performance comparison at S = 32 mm &  $Q_w = 0.444$  lps

For each test, apart from the values of  $Q_a$ ,  $(P_{down} - P_{up})$ , the overall efficiency was also calculated and plotted, a sample of which is shown for the elliptical profiled nozzle in fig. 9. Using the experimental values, *efficiency vs.  $Q_a$*  curve was plotted. Then iso-efficiency curves were plotted on the  $(P_{down} - P_{up})$  vs.  $Q_a$  curves. These curves show the efficiencies of the jet pump for all conditions. In order to plot the iso-efficiency curves, horizontal lines representing constant efficiencies were projected on  $(P_{down} - P_{up})$  vs.  $Q_a$  curves. The points corresponding to the same efficiency were then joined by smooth curves which represent the iso-efficiency lines. Best efficiency points (bep) were found for each flow rate and the bep line was plotted by joining the points of best efficiencies. Here the maximum efficiency of the jet pump realized was 30.2% for a primary water flow rate of 0.444 lps and  $(P_{down} - P_{suc})$  of 1.53 bar.

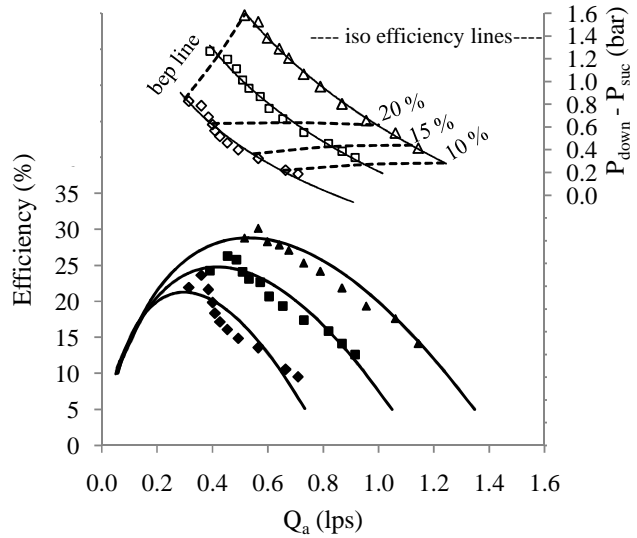

Fig. 9 Overall performance for elliptical profiled nozzle at 32 mm of nozzle spacing (legends are same as those on fig. 5 & fig. 7)

**B. Evacuation Test**

In order to determine the suction capability of the jet pump, evacuation test was conducted. Valve V1 was always kept in the closed position for this test. Fig. 10 is showing the evacuation characteristics with reference to the time at best efficiency point for a nozzle to mixing tube spacing of 32 mm and various primary water flow rates. Similar to the trend followed on fig. 7, suction capability was also increasing with the increment on primary water flow rate ( $Q_w$ ) as shown in fig. 10.

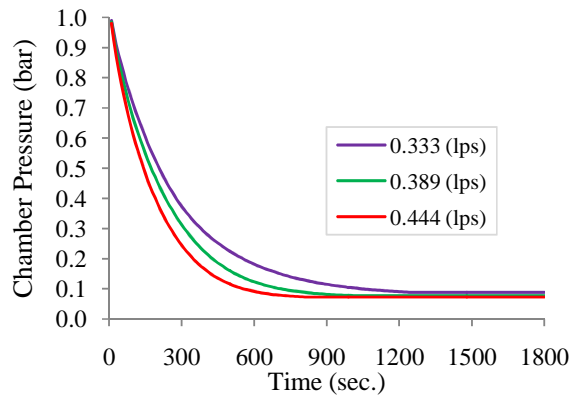

Fig. 10 Evacuation plot for elliptical profiled nozzle at 32 mm of nozzle spacing

Measurements shown in fig 10 were used to determine the maximum time required to reach a minimum absolute pressure for various  $Q_w$ . These points are termed as 'critical'. This minimum absolute pressure was 0.001 bar higher than the lowest pressure obtained in that particular test. This critical time together with the lowest pressure are plotted in fig. 11 as a function of  $Q_w$ .

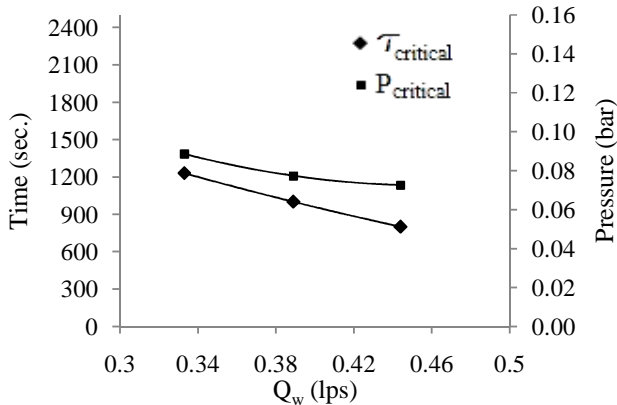

Fig. 11 Critical points for various  $Q_w$  with elliptical profiled nozzle at 32 mm of nozzle spacing

Considering the results shown in fig. 10, tests were also conducted for other profiles at highest primary water flow rate ( $Q_w$ ) as shown in fig. 12. For this purpose nozzle to mixing tube spacing ( $S$ ) was kept constant. It was found that all the nozzle profiles were following almost the same pattern. Hence, to find out the deviation, further one more plot was drawn talking about the *critical* points with reference to all the profiles as shown in fig. 13. Here conical profile was found to be best with a time difference of around 30 sec as compare to elliptical profiled nozzle.

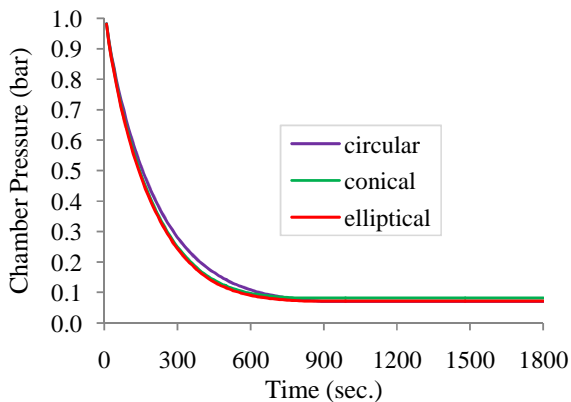

Fig. 12 Comparison of evacuation at  $S = 32$  mm &  $Q_w = 0.444$  lps

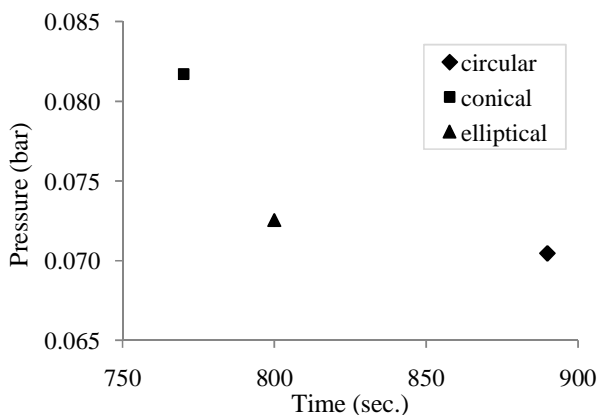

Fig. 13  $t_{critical}$  &  $P_{critical}$  with different profiles

Similarly, all set of experiments were also conducted for 28 mm and 36 mm of nozzle exit to mixing tube entrance spacings ( $S$ ). Among all the spacings, best suited performance of the jet pump was found at 32 mm.

On the basis of the results discussed in present study, this can be concluded that, for the existing test setup, a two-phase flow jet pump with a 4 mm diameter of nozzle as a primary device having elliptical profile can be sized for the best performance at higher primary water flow rates.

#### NOMENCLATURE

|        |  |
|--------|--|
| $A_r$  | Nozzle to mixing tube area ratio                 |
| bep    | Best efficiency point                            |
| LJG    | Liquid Jet Gas Pump                              |
| $M$    | Flow ratio                                       |
| $N$    | Pressure ratio                                   |
| $P$    | Gauge pressure (bar)                             |
| $Q$    | Volumetric flow rate (lps)                       |
| $S$    | Nozzle exit to mixing tube entrance spacing (mm) |
| $\eta$ | Efficiency                                       |
| $t$    | Time   |
| V1     | Air chamber valve                                |
| V2     | Suction line valve                               |
| V3     | Back pressure control valve                      |

#### Subscripts

|      |            |
|------|------------|
| a    | Air        |
| down | Downstream |
| suc  | Suction    |
| up   | Upstream   |
| w    | Water      |

#### REFERENCES

- [1] C. Pfeleiderer, "Experiments on jet pump for its performance," 1914, C. Zeit., VDI, 58, 965 & 1011
- [2] R. C. Martinelli, L. M. K. Boelter, T. H. M. Taylor, E. G. Thomsen, and E. H. Morrin, "Theoretical and experimental analysis of ejectors", 1944, Trans. ASME, 66, pp. 139-151.
- [3] J. H. Witte, "Mixing shocks and their influence on the design of liquid-gas ejectors," 1962, Dissertation, Delft.
- [4] J. H. Witte, "Efficiency and design of liquid-gas ejectors," 1965, British Chemical Engg., 10, pp. 602-607
- [5] R. L. Betzler, "The Liquid-Gas Jet Pump Analysis and Experimental Results," 1969, M.S. Dissertation, Braunschweig.
- [6] S. T. Bonnington, "Jet Pumps and Ejectors, A State of the Art review and bibliography," 1972, BHRA Fluid Engg., Cranfield, Bedford, UK.
- [7] R. G. Cunningham, "Gas Compression with the Liquid Jet Pump," 1974, Trans. ASME, J. Fluids Engg., Series 1, 94(3) pp. 203-215
- [8] B. D. Vyas, and S. Kar, "Study of entrainment and mixing process for an air to air ejector," 1975, BHRA Fluid Engg. Proc., 2nd Symposium on Jet Pumps, Ejectors and Gas Lift Techniques, Cambridge, C2-15-C2-25.
- [9] H. Schmitt, "Diversity of Jet Pumps and Ejector Techniques," 1975, 2nd Symp. Jet Pumps and Ejectors and Gas Lift Techniques, pp. A4-35-50.
- [10] IS 14615 (part 1) : 1999/ISO 5167-1 : 1991, pp. 25-30.
- [11] R. Senthil Kumar, A. Mani, and S. Kumaraswamy, "Selection of Pumps for Vacuum Desalination System Utilizing Ocean Thermal Energy," 2004, 31st National Conference on Fluid Mechanics and Fluid Power, Vol. 1, pp. 409-416.
- [12] R. Senthil Kumar, A. Mani, and S. Kumaraswamy, "Experimental Investigation on Two-Phase Jet Pump used in Desalination System," 2007, Desalination, 204, pp. 437-447.