

Development of the Gas Safety Management System using an Intelligent Gasmeter with Wireless ZigBee Network

Gyou-tae Park†, Young-gyu Kim, Jeong-rock Kwon, Yongwoo Lee, Hiesik Kim*

Abstract—The gas safety management system using an intelligent gas meter we proposed is to monitor flow and pressure of gas, earthquake, temperature, smoke and leak of methane. Then our system takes safety measures to protect a serious risk by the result of an event, to communicate with a wall-pad including a gateway by zigbee network in buildings and to report the event to user by the safety management program in a server. Also, the inner cutoff valve of an intelligent gas meter is operated if any event occurred or abnormal at each sensor.

Keywords—micom gas-meter, gas safety, zigbee, ubiquitous

I. INTRODUCTION

THE modern and high class apartments are equipped with safety devices at facilities of gas, electricity and water. It is clear that a sensor will make our lives safer and more comfortable in the future. We can use it as not only a fire alarm or a gas leak detector, but also a biochemical attack watcher [1, 7]. We propose a gas safety management system using an intelligent multi-function gas meter, which include ZigBee network technology, automatic gas leak cutoff, sensors of smoke, methane, and temperature. At first we developed the intelligent micom-gas-meter which has a built-in cutoff valve and sensors of flow, pressure, and earthquake [2]. That gas meter operates its inner valve and shut off the gas, serving a warning on users if any unusual is occurred for gas flow, pressure, earthquake, temperature, and leakage (methane and CO) in gas pipeline and facilities [3]. Our gas safety management system is configured by the topology of star types with those devices and sensors and then controls all the devices through a wall-pad including a gateway with ZigBee network [4, 5], and takes safety measures to protect a serious risk. In this paper, the proposed system used EM250 ZigBee chips and ZigBee PRO stack [6] and improved the performance of gas

safety Gas safety management system, compared with CC2430 chips [3].

A. The intelligent gas meter (Micom gas meter)

The micom-gas-meter, a kind of gas meter, built in a micro-controller and a cutoff valve, is not only to measure gas flow and pressure but also to monitor earthquake. This instrument can open and close an inner cutoff valve and serve a warning on users if it is uncommon for flow, pressure and earthquake sensors in gas facilities and houses [2]. Fig. 1 shows the appearance of a micom-gas-meter with a wireless ZigBee communication module including EM250.

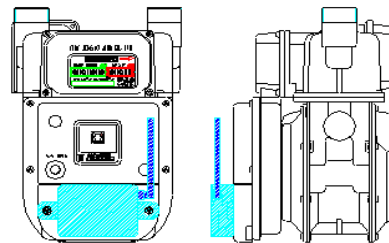

Fig. 1. The appearance of a micom-gas-meter with wireless module

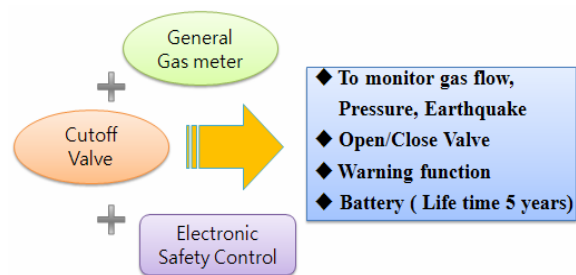

Fig. 2. Components and functions of a micom gas meter

In Fig. 2, the components of a micom gas meter are shown. The micom gas meter consists of mechanic type gas meter adding to a built-in cutoff valve and electronic safety functions, which include cutoff of mass and cumulative, instantaneous rising and descending flow rate, high and low pressure, and an earthquake measuring 3.0 on the Richter scale and alarming and buzzer functions [2]. Table 1 appears safety functions which a micom gas meter can intelligently control itself.

Gyou-tae Park†, Young-gyu Kim, Jeong-rock Kwon are with the Institute of Gas Safety R&D, Korea Gas Safety Corporation, South Korea (†Author: +82-31-310-1432; e-mail: gtparkgs@kgs.or.kr; Ph.D candidate, the School of Electrical and Computer Engineering, University of Seoul, Korea).

Yongwoo Lee, Hiesik Kim* are with the School of Electrical and Computer Engineering, University of Seoul, South Korea (*Corresponding author, phone: +82-2-2210-2569; e-mail: drhskim@uos.ac.kr).

TABLE I FUNCTIONS OF A MICOM GAS METER

No.	Functions
1	The mass flow rate (/h)
2	The cumulative flow rate (/h)
3	The instantaneous rising flow rate (/h)
4	The instantaneous descending flow rate(/h)
5	The detail flow rate (/h)
6	The current pressure (H ₂ O)
7	Set of Upper pressure (H ₂ O)
8	Set of lower pressure (H ₂ O)
9	The continuous use time (min)
10	Open/Close cutoff valve
11	Check cutoff valve
12	Management codes
13	Alarming and buzzer

B. Network Configuration to control micom-gas- meter

Fig.3 shows the diagram of network configuration to operate gas safety management system included in a micom gas meter, ZigBee sensor nodes, a wall-pad controller including a ZigBee sink node, a gas safety management server, a broad band network and users in one house. Line is the connection of wired communication and a dotted line is that of wireless ZigBee network. We configured ZigBee network as the star topology in one house [6, 7] and controlled all the devices through a wall-pad with gateway function. The gas safety management server communicates with a wall-pad controller through LAN cable and is connected to the broadband network like Fig. 3. In ZigBee network, we used EM250 ZigBee devices and ZigBee PRO stack [6]. A wall-pad is used as a IEC266 (32bits RISC ARM920T, 64MB RAM and NAND Flash).

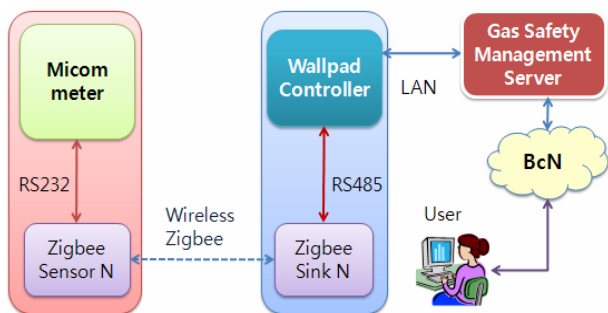

Fig. 3. The network configuration to control a micom gas meter

Table 2 shows communication protocols and baud rates in communication for inter-connection. Users able to connect to sever via internet network(BcN) and to verify the operated condition of the function of a micom gas meter such as on/off of an inner valve, information of pressure and earthquake sensors, and to control each safety instrument.

TABLE II BAUD RATES OF INTER-DEVICES AND NODES

Node	Wired-Protocol
Sensor node ↔ Micom Gas meter	RS-232, 4,800 bps
Sink node ↔ Wall-pad	RS-485, 9,600bps, Half-duplex
Wall pad ↔ USB port	RS-232, 38,400bps
Wallpad ↔ gas safety server	Ethernet 10Mbps

III. GAS SAFETY MANAGEMENT SYSTEM

We configured ZigBee and management network to operate gas safety management system in an apartment consisted in tens of micom gas meters (Fig.4). Signals of micom gas meters intelligently take steps and are transmitted to users, gas suppliers, and common houses via home gateway if it is abnormal. Users can verify gas safety conditions and control gas safety instruments in their home such as flow rate, pressure, and earthquakes with web pages (Fig. 4). Fig.5 shows wired and wireless signal flow of the network of a gas safety management system. This system consists of several devices and a server such as sensor nodes (smoke, CO, LNG, temperature, a micom gas meter, and an automatic extinguisher), a sink node (a wall-pad), ZigBee and BcN communication network. In our home, our gas safety management system can monitor gaseous leakage, pressure, flow, and earthquake conditions to protect gaseous exploration and risks. And then that system automatically operate inner safety functions and inform risk state to users if abnormal state.

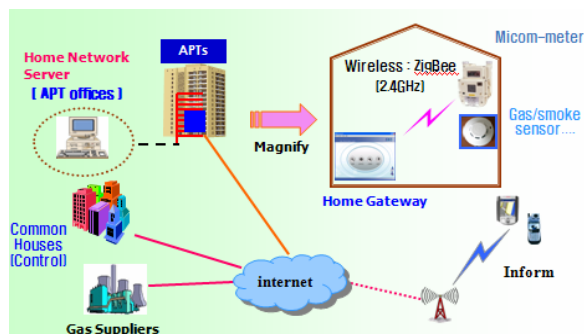

Fig. 4. Network Configuration of a Gas Safety Management System

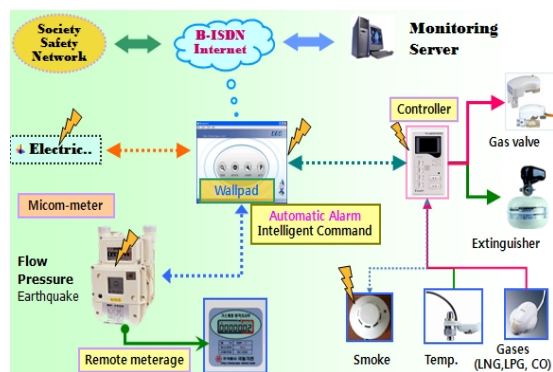

Fig. 5. The signal flow of gas safety management network

Fig. 6 shows a small test bed to experiment operated conditions of a micom gas meter, methane detector, external gas valves through a wall-pad with ZigBee network. In Fig. 7, types of experimental data are showed. The state of cumulative flow rate is abnormal if flow rate is exceeded limit installed in advance. The instantaneous rising flow rate can be occurred if gas pipeline is cracked and flow rate is abruptly increased.

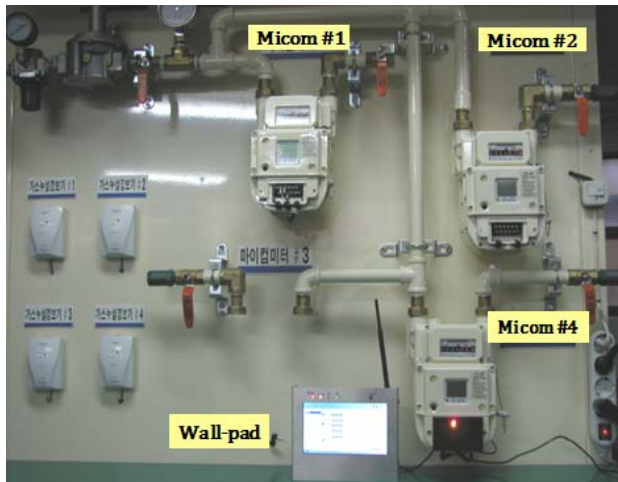

Fig. 6. Experimental devices and Performance Test

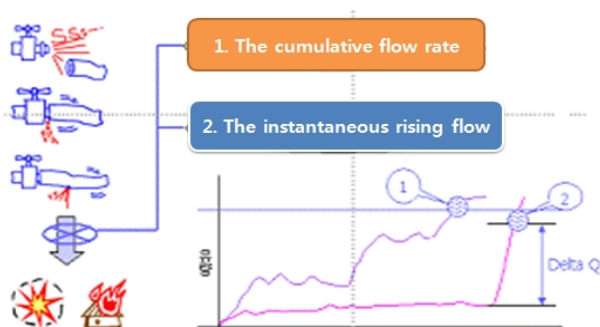

Fig.7. Experimental types for functions

IV. CONCLUSION

We developed a micom gas meter with built-in ZigBee devices and configured ZigBee network to control micom gas meters. We verified that gas safety management system using a micom gas meter can be used to protect an incident effectively. The proposed system takes safety measures while monitoring flow, pressure, and earthquakes in parts of gas facilities and then inform dangerous situations to users as a message through mobile devices. In near future, components of gas, electric, water, and fire safety instruments can be controlled by a ubiquitous sensor network. Our system, then, can be applied to ubiquitous city infrastructure on gas safety management and rise the efficiency of energy safety and reduction. Hopefully, gas incidents are gradually disappeared for our efforts [8].

ACKNOWLEDGMENT

This research was supported by the “Research Group of Energy Safety for Next Generation (2007 MCC23-P031-000)” project from MKE (Ministry of Knowledge Economy) under the program of ETI(Energy Technology Innovation) and “Smart (Ubiquitous) City Consortium(10561)” project from the Seoul R&BD program.

REFERENCES

- [1] Han Park, “An Enhanced Key Management Scheme Based on Key Infection in Wireless Sensor Network”, World Academy of Science, Engineering and Technology 60, pp.249-254, 2009.
- [2] <http://www.gas-meter.com>
- [3] G. T. Park, G. J Lyu and Y. G Kim “Implementation of gas safe management system using micom gas-meter with wireless zigbee communication,” Korea Information and Communication Society. Vol. 1, pp. 122–123, June 2008.
- [4] ZigBee Alliance, ZigBee-2009 Specification : ZigBee Document, 2009
- [5] IEEE 802.15.4-2006 standard for wireless personal area networks (WPANs)
- [6] Ember Corporation, EmberZNet Application Developer’s Reference Manual, 2008
- [7] Ata Elahi, Gschwender, “Zigbee Wireless Sensor and Control Network”, Prentice Hall, 2009
- [8] Korea Gas Safety Corporation, “2009 The Statistics of Gas incident”, 2009.



Gyou-tae Park was born at Kyong-buk Province in South Korea on 29th Mar., 1970. Now he as a candidate for doctoral degree of School of Electrical and Computer Engineering is studying at University of Seoul, Korea. He has earned the B.S. and M.S. degree in Electronic Engineering at the Yeongnam University, Gyeongsan, Korea in 1996 and 1999 respectively. He is currently a senior researcher of Electrical and Computer Engineering on based Gas Safety Facilities at Korea Gas Safety Corporation (KGS). His research interests focus on IT convergence technology for gas safety management, solar cell/heat and Energy.