

Development of Admire Longitudinal Quasi-Linear Model by using State Transformation Approach

Jianqiao. Yu, Jianbo. Wang, And Xinzhen. He

Abstract—This paper presents a longitudinal quasi-linear model for the ADMIRE model. The ADMIRE model is a nonlinear model of aircraft flying in the condition of high angle of attack. So it can't be considered to be a linear system approximately. In this paper, for getting the longitudinal quasi-linear model of the ADMIRE, a state transformation based on differentiable functions of the nonscheduling states and control inputs is performed, with the goal of removing any nonlinear terms not dependent on the scheduling parameter. Since it needn't linear approximation and can obtain the exact transformations of the nonlinear states, the above-mentioned approach is thought to be appropriate to establish the mathematical model of ADMIRE. To verify this conclusion, simulation experiments are done. And the result shows that this quasi-linear model is accurate enough.

Keywords—quasi-linear model, simulation, state transformation approach, the ADMIRE model.

I. INTRODUCTION

THE admire, the aero-data model in a research environment, is a nonlinear six degree of freedom simulation model developed by the Swedish Defence Research Agency using aerodynamic data obtained from a generic single-seat, single-engine fighter aircraft with a delta-canard configuration [1]. ADMIRE is augmented with a full-authority flight control system and includes engine dynamics and detailed actuator models. It includes a large number of uncertain aerodynamic, actuator, sensor, and inertia parameters, whose values within specified ranges can be set by the user.

The aerodynamic functions are defined over a wide flight envelope with a significant range of Mach number (0.3 to 1.2) and wide ranges of angle of attack (-30° to 90°) and sideslip angle (-30° to 30°) at low subsonic speeds. And the configuration of the model is showed as in Fig. 1.

In this paper, a longitudinal quasi-linear model of ADMIRE will be established by using state transformation method. The approach of state transformation is called state transformation because the quasi-LPV model is obtained through exact transformations of the nonlinear states [2]. It basically performs a state transformation based on differentiable functions of the

nonscheduling states and control inputs with the goal of removing any nonlinear terms not dependent on the scheduling parameter [4]. This technique was introduced by Shamma and Cloutier. And it has been applied to a wide range of applications [5] – [8].

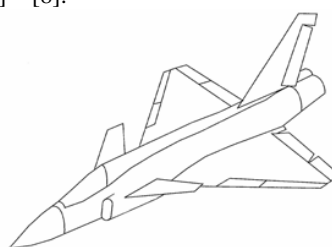

Fig. 1 Principal layout of the configuration

At the end of this paper, simulation experiments are done to verify the accuracy of this model.

II. AIRCRAFT DYNAMIC MODEL

A. Definition of Reference Frame

There are two frames used in the course of establishing the aircraft dynamic mode— S_B -frame and S_U -frame. They are shown as in Fig. 2 and Fig. 3 [1].

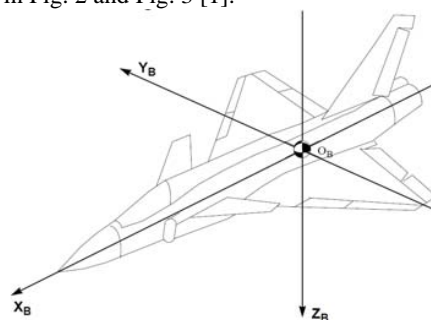
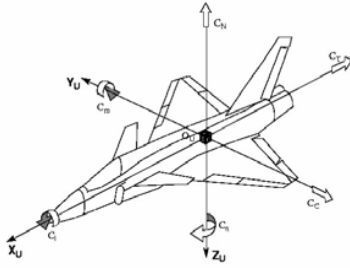

Fig. 2 Body fixed frame, S_B -frame

Jianqiao. Yu is with the School of Aerospace Engineering, Beijing Institute of Technology, Beijing, 100081 China (e-mail: jianqiao@bit.edu.cn).

Jianbo. Wang is with the School of Aerospace Engineering, Beijing Institute of Technology, Beijing, 100081 China (e-mail: wangjianbo3@163.com).

Xinzhen. He is with Lanzhou University, Lanzhou, 730000 China.

 Fig. 3 S_U-frame

The origin of S_B-frame is the centre of gravity (O_B), and the origin of S_U-frame is the aerodynamic reference point (O_U). The reference point is fixed but the location of the centre of gravity can change. In the nominal case, these two points coincide. The relative position of the two points is shown as in Fig. 4 [1].

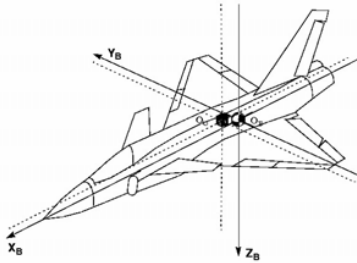

Fig. 4 Definition of reference frames

B. Forces and Moments

In Fig. 3, the definition of the direction of the forces and moments from the aero data is shown. There are six aerodynamic coefficients defined— $C_T, C_N, C_C, C_l, C_m, C_n$. And then the aerodynamic forces and moments can be written as

$$\begin{aligned} F_x &= -\bar{q} \cdot S_{ref} \cdot C_{Tot}, \\ F_y &= -\bar{q} \cdot S_{ref} \cdot C_{Clot}, \\ F_z &= -\bar{q} \cdot S_{ref} \cdot C_{Nlot}, \\ M_x &= \bar{q} \cdot S_{ref} \cdot b_{ref} \cdot C_{lTot} - z_{cg} \cdot F_y + y_{cg} \cdot F_z, \\ M_y &= \bar{q} \cdot S_{ref} \cdot b_{ref} \cdot C_{mTot} - x_{cg} \cdot F_y + z_{cg} \cdot F_x, \\ M_z &= \bar{q} \cdot S_{ref} \cdot b_{ref} \cdot C_{nTot} + x_{cg} \cdot F_y - y_{cg} \cdot F_x, \end{aligned}$$

where \bar{q} is the dynamic pressure of the plane, and $\bar{q} = \frac{1}{2} \rho V^2$ (ρ is the density of the air and V is the velocity of the plane); S_{ref} is the area of the wing; b_{ref} is the length of the wingspan; x_{cg} , y_{cg} and z_{cg} are the relative distance between the centre of gravity and the aerodynamic reference point which are not a fixed coordinate.

Now the expressions of lift coefficient and drag coefficient shown as (1) and (2) can be gotten.

$$C_L = C_N \cos \alpha - C_T \sin \alpha \quad (1)$$

$$C_D = C_N \sin \alpha + C_T \cos \alpha \quad (2)$$

C. The Plane's Longitudinal Motion Equations

For achieving the plane's independent longitudinal motion equations, some assumptions are made: the plane just flies in the vertical plane and the lateral coefficients are very small so that they have no impact on the longitudinal coefficients. The deflection of pitch motion is just decided by longitudinal motion coefficients, and the deflection of yaw motion and roll motion is just decided by lateral motion coefficients. That is to say, there is no deflection of yaw motion and roll motion, and the deviation from the zero value caused by the lateral motion coefficients which are produced by various interference factors can be cleared away very fast. According to these assumptions, the plane's longitudinal motion equations [3] can be gotten.

$$\left. \begin{aligned} m \frac{dV}{dt} &= T \cos \alpha - D - mg \sin \gamma \\ mV \frac{d\gamma}{dt} &= T \sin \alpha + L - mg \cos \gamma \\ I_y \frac{dq}{dt} &= M \\ \frac{dx}{dt} &= V \cos \gamma \\ \frac{dy}{dt} &= V \sin \gamma \\ \frac{d\theta}{dt} &= q \\ \frac{dm}{dt} &= -m_c \\ \alpha &= \theta - \gamma \\ \phi_1 &= 0 \\ \phi_2 &= 0 \end{aligned} \right\} \quad (3)$$

where L, D, M are lift, drag and pitch moment.; T is the thrust which is parallel to the direction of x_B -axis.; $V, \theta, \gamma, q, \alpha$ are velocity, pitch angle, flight path angle, pitch rate, angle of attack; x, y are the plane's coordinates in inertial reference frame; m, I_y, g, m_c are aircraft total mass, body axis moment of inertia, acceleration due to gravity, variation of aircraft mass in one second; ϕ_1, ϕ_2 are control relation equations.

III. DEVELOPMENT OF AIRCRAFT LONGITUDINAL QUASI-LINEAR MODEL

A. Aircraft Longitudinal State-space Equations

Considering the characteristics of the aircraft longitudinal motion, α, q are chosen as variable state vector, and h , the height of aircraft, take the place of y . The differential equation about q has been given in (3). Now the differential equation about α can be obtained from (3), too.

By the 8th equation of (3) time t to derivatives, (4) can be

gotten.

$$\frac{d\alpha}{dt} = \frac{d\theta}{dt} - \frac{d\gamma}{dt} \quad (4)$$

With the 2nd and 6th equations of (3), the (4) can be rewritten as (5).

$$\frac{d\alpha}{dt} = q - \frac{T \sin \alpha + L - mg \cos \gamma}{mV} \quad (5)$$

Now all the differential equations needed are gotten, and they can be shown as (6).

$$\left. \begin{aligned} \dot{\alpha} &= q - \frac{T \sin \alpha + L - mg \cos \gamma}{mV} \\ \dot{q} &= \frac{M}{I_y} \end{aligned} \right\} \quad (6)$$

B. Simplification of Aerodynamic Coefficients

Although the state-space (6) has been gotten, it isn't the form needed. So it should be developed further.

There are just two forces and one moment in (6): lift L , drag D , and pitching moment M . And they can be written as (7).

$$\begin{aligned} L &= \bar{q} S C_L \\ D &= \bar{q} S C_D \\ M &= \bar{q} S \bar{c} C_M, \end{aligned} \quad (7)$$

where S is the area of wing surface; \bar{c} is the average value of aerodynamic chord; C_L is coefficient of lift; C_D is coefficient of drag; C_M is coefficient of pitching moment; $\bar{q} = \frac{1}{2} \rho V^2$ is dynamic pressure; ρ , a function of h , is the density of the atmosphere.

According to (7), the problems of forces and moments can be changed into the problems of aerodynamic coefficients. As the longitudinal motion of aircraft is only researched, it is just needed to be considered of coefficient of lift, coefficient of drag and coefficient of pitching moment. And these three coefficients can be decided by other three coefficients. They are coefficient of tangential force C_T , coefficient of normal force C_N , and coefficient of pitching moment C_m . So the latter three coefficients are the ones that should be considered. These coefficients usually can be gotten by using the interpolation tables which are gotten by using the real data of aircraft and the experiment of tunnel. These coefficients can be simplified according to the size and physical meaning of the components of these coefficients.

Besides the structure of aircraft, these coefficients also can be impacted by Mach number, angle of attack and system parameters. In the model of ADMIRE, the system parameters are left canard deflection δ_{lc} , right canard deflection δ_{rc} , left outer elevon deflection δ_{loe} , right outer elevon deflection δ_{roe} , left inner elevon deflection δ_{lie} , right inner elevon deflection δ_{rie} , rudder deflection δ_r , leading edge flap deflection δ_{le} ,

horizontal thrust vectoring δ_{th} , and vertical thrust vectoring δ_{tv} .

And in different area of Mach number Ma , these aerodynamic coefficients are different. They will change when Mach number in the area of 0.4 to 0.5 and when $Ma = 1.4$. In this paper, the situation of $Ma \leq 0.4$ is just researched.

Here, some definitions are made in (8).

$$\begin{aligned} \delta_{ei} &= (\delta_{lie} + \delta_{rie})/2 \\ \delta_{ai} &= (\delta_{lie} - \delta_{rie})/2 \\ \delta_{ey} &= (\delta_{loe} + \delta_{roe})/2 \\ \delta_{ay} &= (\delta_{loe} - \delta_{roe})/2 \\ \delta_{ne} &= (\delta_{lc} + \delta_{rc})/2 \\ \delta_{na} &= (\delta_{lc} - \delta_{rc})/2 \\ \delta_n &= \delta_{ne} \\ \delta_e &= (\delta_{ei} + \delta_{ey})/2 \end{aligned} \quad (8)$$

1. Simplifying Coefficient of Tangential Force

The coefficient of tangential force can be written as (9) before being simplified [1].

$$\begin{aligned} C_{T_{tot}} &= C_{T_{basic}} + C_{T_\alpha} + C_{T_{\delta_{ai}}} + C_{T_{\delta_{ay}}} + C_{T_{\delta_e \delta_n}} + C_{T_{\delta_n}} + C_{T_{\delta_{le}}} \\ &+ C_{T_{\delta_{ia}}} + C_{T_\beta} + C_{T_{\delta_r}} + C_T^{high}, \end{aligned} \quad (9)$$

where they are all the components of coefficient of tangential force decided by angle of attack or other system parameters.

By ignoring the impact of left elevon deflection, angle of sideslip, leading edge flap deflection, rudder deflection and other small components, coefficient of tangential force can be simplified as (10).

$$C_T = C_{T_0}(M) + C_{T_\alpha}(\alpha) + C_{T_{\delta_n, \alpha}}(\delta_n, \alpha), \quad (10)$$

where

- $C_{T_0}(M)$ is the basic component of coefficient of tangential force, which is only related to Mach number. It can be gotten by using one-dimensional interpolation methods;
- $C_{T_\alpha}(\alpha)$ is related to angle of attack. And according to the data table, when angle of attack is a positive number, it is a big negative number;
- $C_{T_{\delta_n, \alpha}}(\delta_n, \alpha)$ is related to canard deflection. It is the most important component that should be considered and it should be linearized.

2. Simplifying Coefficient of Normal Force

The coefficient of normal force can be written as (11) before being simplified [1].

$$\begin{aligned} C_{N_{tot}} &= C_{N_{basic}} + C_{N_\alpha} + C_{N_{\delta_{ei}}} + C_{N_{\delta_{ey}}} + C_{N_{\delta_e \delta_n}} + C_{N_{\delta_n}} + C_{N_{\delta_{le}}} \\ &+ C_{N_{cai}} + C_{N_\beta} + C_{N_{\dot{\alpha}}} + C_{N_q} + C_{N_{n_z}} + C_{N_{\dot{q}}} + C_N^{high}, \end{aligned} \quad (11)$$

where they are all the components of coefficient of normal force decided by angle of attack or other system parameters.

By ignoring the impact of left elevon deflection, angle of sideslip, leading edge flap deflection, rudder deflection and other small components, coefficient of normal force can be simplified as (12).

$$\begin{aligned}
 C_N &= C_{N_{basic}} + C_{N_\alpha} + C_{N_{\delta_n}} + C_{N_q} \\
 &= C_{N_0}(M) + C_{N_{\delta_e\alpha}}(0, \alpha) C_{N_{eq}}(qa_{corr}, M) \\
 &\quad + C_{N_{\delta_n\alpha}}(\delta_n, \alpha) C_{N_{e\delta_n}}(qa_{corr}, M) + C_{N_{q\alpha}}(|\alpha|) \cdot q_c \cdot C_{N_{eq}}(qa_{corr}, M),
 \end{aligned}
 \tag{12}$$

where

- a) $C_{N_0}(M)$ is the basic component of coefficient of normal force, which is only related to Mach number;
- b) $C_{N_{\delta_e\alpha}}(0, \alpha) \cdot C_{N_{eq}}(qa_{corr}, M)$ is related to dynamic pressure and Mach number, where $qa_{corr} = qa * 0.0001$, and qa is dynamic pressure;
- c) $C_{N_{\delta_n\alpha}}(\delta_n, \alpha) C_{N_{e\delta_n}}(qa_{corr}, M)$ is related to canard deflection;
- d) In the component of $C_{N_{q\alpha}}(|\alpha|) \cdot q_c \cdot C_{N_{eq}}(qa_{corr}, M)$, $q_c = qc / (2V)$, where q is pitch rate and c is aerodynamic chord.

3. Simplifying Coefficient of Pitching Moment

The coefficient of pitching moment can be written as (13) before being simplified.

$$\begin{aligned}
 C_{m_{tot}} &= C_{m_{basic}} + C_{m_\alpha} + C_{m_{\delta_{ei}}} + C_{m_{\delta_{ey}}} + C_{m_{\delta_e\delta_n}} + C_{m_{\delta_n}} \\
 &\quad + C_{m_{\delta_{ie}}} + C_{m_{\delta_{ai}}} + C_{m_\beta} + C_{m_{\dot{z}}} + C_{m_q} + C_{m_{n_z}} \\
 &\quad + C_{m_{\dot{q}}} + C_m^{high},
 \end{aligned}
 \tag{13}$$

where they are all the components of coefficient of pitching moment decided by angle of attack or other system parameters.

By ignoring the impact of left elevon deflection, angle of sideslip, leading edge flap deflection, rudder deflection and other small components, coefficient of pitching moment can be simplified as (14).

$$\begin{aligned}
 C_m &= C_{m_{basic}} + C_{m_\alpha} + C_{m_{\delta_n}} + C_{m_q} \\
 &= C_{m_0}(M) + C_{m_{\delta_e\alpha}}(0, \alpha) \\
 &\quad + C_{m_{\delta_n\alpha}}(\delta_n, \alpha) \cdot C_{m_{e\delta_n}}(qa_{corr}, M) \\
 &\quad + (C_{m_{q\alpha}}(\alpha) + C_{m_{\delta_n\alpha}}(\delta_n, \alpha)) \cdot q_c \cdot C_{m_{eq}}(qa_{corr}, M),
 \end{aligned}
 \tag{14}$$

where

- a) $C_{m_0}(M)$ is the basic component of coefficient of pitching moment, which is only related to Mach number;
- b) $C_{m_{\delta_e\alpha}}(0, \alpha)$ is related to angle of attack;
- c) $C_{m_{\delta_n\alpha}}(\delta_n, \alpha) \cdot C_{m_{e\delta_n}}(qa_{corr}, M)$ is related to canard deflection;
- d) $(C_{m_{q\alpha}}(\alpha) + C_{m_{\delta_n\alpha}}(\delta_n, \alpha)) \cdot q_c \cdot C_{m_{eq}}(qa_{corr}, M)$ is related to pitch rate.

4. Simulation

According to the simplification, it can be known that the component of C^{high} is ignored in every coefficients. This component is the correction term to big angle of attack. IT is ignored here, because the range of angle attack is -10° to 30° .

To get the relation between these coefficients and angle of

attack and Mach number, some simulations are done by using MATLAB programming. With the (1) and the (2) and letting the range of angle of attack be 0° to 30° , the efficient curves as Fig. 5 to Fig. 9 can be gotten, where the four curves in every picture is gotten when Mach number equal to 0.1 or 0.2 or 0.3 or 0.4.

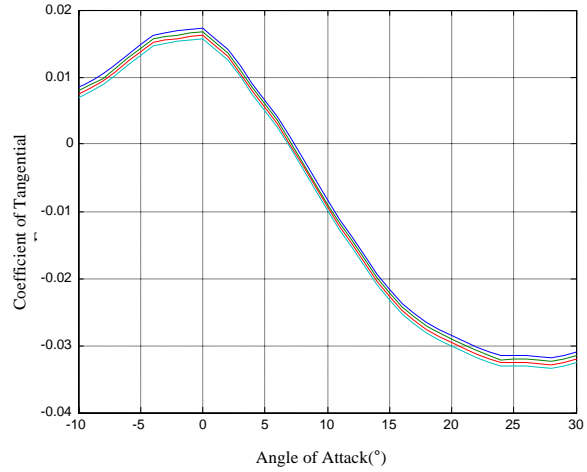

Fig. 5 Coefficient of Tangential Force for different Mach numbers after being simplified

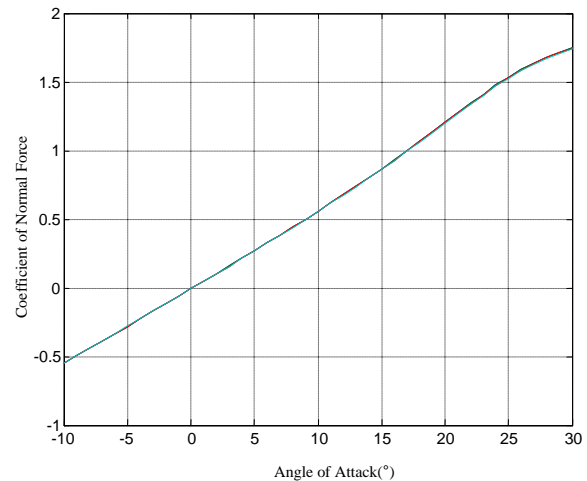

Fig. 6 Coefficient of Normal Force for different Mach numbers after being simplified

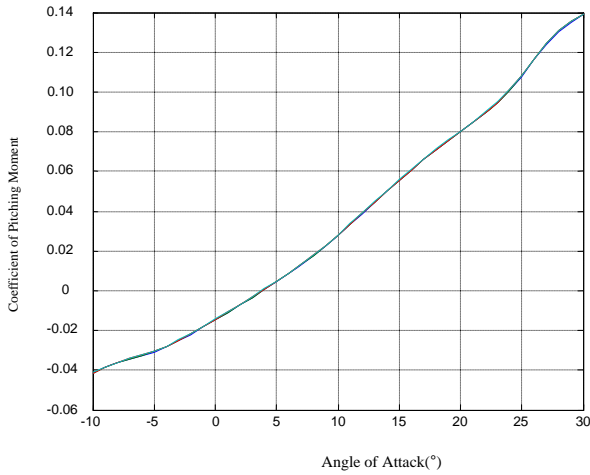

Fig. 7 Coefficient of Pitching Moment for different Mach numbers after being simplified

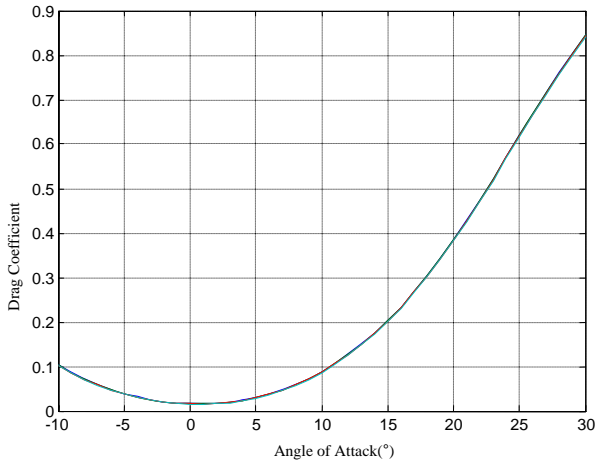

Fig. 8 Drag Coefficient for different Mach numbers after being simplified

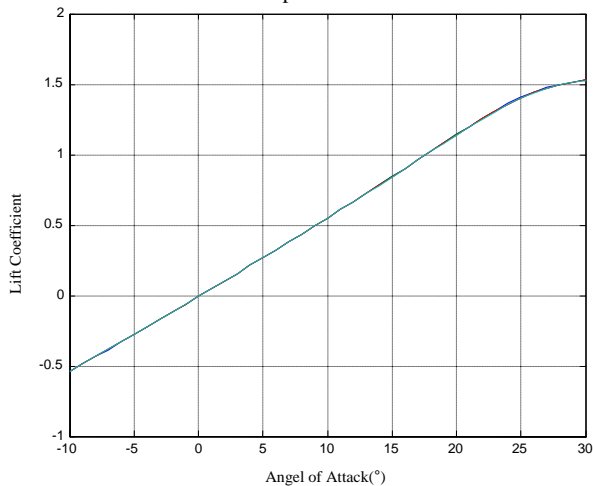

Fig. 9 Lift Coefficient for different Mach numbers after being simplified

According to these curves, it can be known that angle of attack is the main factor which affect these coefficients when

$$Ma \leq 0.4.$$

C. Establishing The Longitudinal Quasi-linear Model of The ADMIRE

With (10) and (12), (1) and (2) can be rewritten as (15) and (16).

$$\begin{aligned} C_L = & \left[C_{N_0}(M) \cos \alpha - C_{T_0}(M) \sin \alpha \right] \\ & + \left[C_{N_{\delta_{\epsilon\alpha}}}(0, \alpha) C_{N_{\epsilon\alpha}}(qa_{corr}, M) \cos \alpha - C_{T_{\alpha}}(\alpha) \sin \alpha \right] \\ & + \left[C_{N_{\delta_n\alpha}}(\delta_n, \alpha) C_{N_{\epsilon\delta_n}}(qa_{corr}, M) \cos \alpha - C_{T_{\delta_n\alpha}}(\delta_n, \alpha) \sin \alpha \right] \\ & + C_{N_{qa}}(|\alpha|) \cdot q_c \cdot C_{N_{eq}}(qa_{corr}, M) \cos \alpha \end{aligned} \quad (15)$$

$$\begin{aligned} C_D = & \left[C_{N_0}(M) \sin \alpha + C_{T_0}(M) \cos \alpha \right] \\ & + \left[C_{N_{\delta_{\epsilon\alpha}}}(0, \alpha) C_{N_{\epsilon\alpha}}(qa_{corr}, M) \sin \alpha + C_{T_{\alpha}}(\alpha) \cos \alpha \right] \\ & + \left[C_{N_{\delta_n\alpha}}(\delta_n, \alpha) C_{N_{\epsilon\delta_n}}(qa_{corr}, M) \sin \alpha + C_{T_{\delta_n\alpha}}(\delta_n, \alpha) \cos \alpha \right] \\ & + C_{N_{qa}}(|\alpha|) \cdot q_c \cdot C_{N_{eq}}(qa_{corr}, M) \sin \alpha \end{aligned} \quad (16)$$

According to (6), (14), (15), and (16), the mathematical model of the aircraft as (17) can be gotten.

$$\begin{aligned} \begin{bmatrix} \dot{\alpha} \\ \dot{q} \end{bmatrix} = & \begin{bmatrix} -\frac{\bar{q}S}{mV} \left[\begin{aligned} & \left[C_{N_0}(M) \cos \alpha - C_{T_0}(M) \sin \alpha \right] \\ & + \left[C_{N_{\delta_{\epsilon\alpha}}}(0, \alpha) C_{N_{\epsilon\alpha}}(qa_{corr}, M) \cos \alpha - C_{T_{\alpha}}(\alpha) \sin \alpha \right] \\ & + \left[C_{N_{\delta_n\alpha}}(\delta_n, \alpha) C_{N_{\epsilon\delta_n}}(qa_{corr}, M) \cos \alpha - C_{T_{\delta_n\alpha}}(\delta_n, \alpha) \sin \alpha \right] \end{aligned} \right] \\ \frac{\bar{q}S\bar{c}}{I_y} \left[C_{m_0}(M) + C_{m_{\delta_{\epsilon\alpha}}}(0, \alpha) + C_{m_{\delta_n\alpha}}(\delta_n, \alpha) \cdot C_{m_{\epsilon\delta_n}}(qa_{corr}, M) \right] \end{bmatrix} \begin{bmatrix} \alpha \\ q \end{bmatrix} \\ + & \begin{bmatrix} 0 & 1 - \frac{\bar{q}S}{mV} C_{N_{qa}}(|\alpha|) \cdot C_{N_{eq}}(qa_{corr}, M) \cos \alpha \frac{\bar{c}}{2V} \\ 0 & \frac{\bar{q}S\bar{c}}{I_y} \left[C_{m_{qa}}(\alpha) + C_{m_{\delta_{\epsilon\alpha}}}(0, \alpha) \cdot C_{m_{eq}}(qa_{corr}, M) \right] \frac{\bar{c}}{2V} \end{bmatrix} \begin{bmatrix} \alpha \\ q \end{bmatrix} \end{aligned} \quad (17)$$

For looking simple, some variables are defined :

$$\begin{aligned} AX = & \left[C_{N_0}(M) \sin \alpha + C_{T_0}(M) \cos \alpha \right] \\ & + \left[C_{N_{\delta_{\epsilon\alpha}}}(0, \alpha) C_{N_{\epsilon\alpha}}(qa_{corr}, M) \sin \alpha + C_{T_{\alpha}}(\alpha) \cos \alpha \right] \\ BX = & \left[C_{N_0}(M) \cos \alpha - C_{T_0}(M) \sin \alpha \right] \\ & + \left[C_{N_{\delta_{\epsilon\alpha}}}(0, \alpha) C_{N_{\epsilon\alpha}}(qa_{corr}, M) \cos \alpha - C_{T_{\alpha}}(\alpha) \sin \alpha \right] \\ CX = & C_{m_0}(M) + C_{m_{\delta_{\epsilon\alpha}}}(0, \alpha) \\ C_{D_{\delta_n\alpha}}(\delta_n, \alpha) = & C_{N_{\delta_n\alpha}}(\delta_n, \alpha) C_{N_{\epsilon\delta_n}}(qa_{corr}, M) \sin \alpha \\ & + C_{T_{\delta_n\alpha}}(\delta_n, \alpha) \cos \alpha \\ C_{L_{\delta_n\alpha}}(\delta_n, \alpha) = & C_{N_{\delta_n\alpha}}(\delta_n, \alpha) C_{N_{\epsilon\delta_n}}(qa_{corr}, M) \cos \alpha \\ & - C_{T_{\delta_n\alpha}}(\delta_n, \alpha) \sin \alpha \\ C_{m_{\delta_n\alpha}}(\delta_n, \alpha) = & C_{m_{\delta_n\alpha}}(\delta_n, \alpha) \cdot C_{m_{\epsilon\delta_n}}(qa_{corr}, M). \end{aligned}$$

Then, the mathematical model can be written as (18).

$$\begin{bmatrix} \dot{\alpha} \\ \dot{q} \end{bmatrix} = \begin{bmatrix} -\frac{\bar{q}S}{mV} [BX + C_{L_{\delta_n\alpha}}(\delta_n, \alpha)] - \frac{\sin \alpha}{mV} T \\ \frac{\bar{q}S\bar{c}}{I_y} [CX + C_{m_{\delta_n\alpha}}(\delta_n, \alpha)] \end{bmatrix} + \begin{bmatrix} 0 & 1 - \frac{\bar{q}S}{mV} C_{N_{q\alpha}}(|\alpha|) \cdot C_{N_{eq}}(q_{corr}, M) \cos \alpha \frac{\bar{c}}{2V} \\ 0 & \frac{\bar{q}S\bar{c}}{I_y} [C_{m_{q\alpha}}(\alpha) + C_{m_{\delta_n\alpha}}(\delta_n, \alpha)] \cdot C_{m_{eq}}(q_{corr}, M) \frac{\bar{c}}{2V} \end{bmatrix} \begin{bmatrix} \alpha \\ q \end{bmatrix} \quad (18)$$

Equation (18) is the motion state equation of aircraft.

Considering the canard deflection δ_n as the control input, it can be found that (18) is not linear to canard deflection δ_n . So it should be known of the first-order Taylor expansions of $C_{L_{\delta_n\alpha}}(\delta_n, \alpha)$ and $C_{m_{\delta_n\alpha}}(\delta_n, \alpha)$. And they are given by

$$\begin{aligned} C_{L_{\delta_n\alpha}}(\delta_n, \alpha) &\approx C_{L_{\delta_n\alpha}}(\delta_{neq}, \alpha) + D[C_{L_{\delta_n\alpha}}(\delta_{neq}, \alpha)](\delta_n - \delta_{neq}) \\ C_{m_{\delta_n\alpha}}(\delta_n, \alpha) &\approx C_{m_{\delta_n\alpha}}(\delta_{neq}, \alpha) + D[C_{m_{\delta_n\alpha}}(\delta_{neq}, \alpha)](\delta_n - \delta_{neq}), \end{aligned}$$

where $D(\bullet) = \frac{\partial(\bullet)}{\partial \delta_n}$.

With the Taylor expansions, (18) can be rewritten as (19).

$$\begin{bmatrix} \dot{\alpha} \\ \dot{q} \end{bmatrix} = \begin{bmatrix} -\frac{\bar{q}S}{mV} [BX + C_{L_{\delta_n\alpha}}(\delta_{neq}, \alpha)] - \frac{\sin \alpha}{mV} T \\ \frac{\bar{q}S\bar{c}}{I_y} [CX + C_{m_{\delta_n\alpha}}(\delta_{neq}, \alpha)] \end{bmatrix} + \begin{bmatrix} 0 & 1 - \frac{\bar{q}S}{mV} C_{N_{q\alpha}}(|\alpha|) \cdot C_{N_{eq}}(q_{corr}, M) \cos \alpha \frac{\bar{c}}{2V} \\ 0 & \frac{\bar{q}S\bar{c}}{I_y} [C_{m_{q\alpha}}(\alpha) + C_{m_{\delta_n\alpha}}(\delta_n, \alpha)] \cdot C_{m_{eq}}(q_{corr}, M) \frac{\bar{c}}{2V} \end{bmatrix} \begin{bmatrix} \alpha \\ q \end{bmatrix} + \begin{bmatrix} -\frac{\bar{q}S}{mV} D[C_{L_{\delta_n\alpha}}(\delta_{neq}, \alpha)] \\ \frac{\bar{q}S\bar{c}}{I_y} D[C_{m_{\delta_n\alpha}}(\delta_{neq}, \alpha)] \end{bmatrix} \begin{bmatrix} \delta_n - \delta_{neq} \end{bmatrix} \quad (19)$$

Letting the left side of (18) equal to zero, (20) can be gotten.

$$\begin{bmatrix} 0 \\ 0 \end{bmatrix} = \begin{bmatrix} -\frac{\bar{q}S}{mV} [BX + C_{L_{\delta_n\alpha}}(\delta_{neq}, \alpha)] - \frac{\sin \alpha}{mV} T \\ \frac{\bar{q}S\bar{c}}{I_y} [CX + C_{m_{\delta_n\alpha}}(\delta_{neq}, \alpha)] \end{bmatrix} + \begin{bmatrix} 0 & 1 - \frac{\bar{q}S}{mV} C_{N_{q\alpha}}(|\alpha|) \cdot C_{N_{eq}}(q_{corr}, M) \cos \alpha \frac{\bar{c}}{2V} \\ 0 & \frac{\bar{q}S\bar{c}}{I_y} [C_{m_{q\alpha}}(\alpha) + C_{m_{\delta_n\alpha}}(\delta_n, \alpha)] \cdot C_{m_{eq}}(q_{corr}, M) \frac{\bar{c}}{2V} \end{bmatrix} \begin{bmatrix} \alpha \\ q - q_{eq} \end{bmatrix} \quad (20)$$

Equation (19) less (20) and (21) can be gotten.

$$\begin{bmatrix} \dot{\alpha} \\ \dot{q} \end{bmatrix} = \begin{bmatrix} 0 & 1 - \frac{\bar{q}S}{mV} C_{N_{q\alpha}}(|\alpha|) \cdot C_{N_{eq}}(q_{corr}, M) \cos \alpha \frac{\bar{c}}{2V} \\ 0 & \frac{\bar{q}S\bar{c}}{I_y} [C_{m_{q\alpha}}(\alpha) + C_{m_{\delta_n\alpha}}(\delta_n, \alpha)] \cdot C_{m_{eq}}(q_{corr}, M) \frac{\bar{c}}{2V} \end{bmatrix} \begin{bmatrix} \alpha \\ q - q_{eq} \end{bmatrix} + \begin{bmatrix} -\frac{\bar{q}S}{mV} D[C_{L_{\delta_n\alpha}}(\delta_{neq}, \alpha)] \\ \frac{\bar{q}S\bar{c}}{I_y} D[C_{m_{\delta_n\alpha}}(\delta_{neq}, \alpha)] \end{bmatrix} \begin{bmatrix} \delta_n - \delta_{neq} \end{bmatrix} \quad (21)$$

Here, \dot{q}_{eq} should be known, and with (20), (22) can be gotten.

$$\begin{aligned} &-\frac{\bar{q}S}{mV} [BX + C_{L_{\delta_n\alpha}}(\delta_{neq}, \alpha)] - \frac{\sin \alpha}{mV} T \\ &+ \left[1 - \frac{\bar{q}S}{mV} C_{N_{q\alpha}}(|\alpha|) \cdot C_{N_{eq}}(q_{corr}, M) \cos \alpha \frac{\bar{c}}{2V} \right] \cdot q_{eq} = 0 \end{aligned} \quad (22)$$

And then with (22), q_{eq} is written as (23).

$$\begin{aligned} q_{eq} &= \frac{\frac{\bar{q}S}{mV} [BX + C_{L_{\delta_n\alpha}}(\delta_{neq}, \alpha)] + \frac{\sin \alpha}{mV} T}{1 - \frac{\bar{q}S}{mV} C_{N_{q\alpha}}(|\alpha|) \cdot C_{N_{eq}}(q_{corr}, M) \cos \alpha \frac{\bar{c}}{2V}} \\ &= \frac{\bar{q}S [BX + C_{L_{\delta_n\alpha}}(\delta_{neq}, \alpha)] + \sin \alpha T}{mV - \bar{q}S C_{N_{q\alpha}}(|\alpha|) \cdot C_{N_{eq}}(q_{corr}, M) \cos \alpha \frac{\bar{c}}{2V}} \end{aligned} \quad (23)$$

By (23) t to derivatives, (24) can be gotten.

$$\begin{aligned} \dot{q}_{eq} &= \frac{dq_{eq}}{dt} \cdot \dot{\alpha} \\ &= \frac{\left\{ \bar{q}S [BX^\alpha + C_{L_{\delta_n\alpha}}^\alpha(\delta_{neq}, \alpha)] + \cos \alpha \cdot T \left[mV - \bar{q}S C_{N_{q\alpha}}(|\alpha|) \cdot C_{N_{eq}}(q_{corr}, M) \cos \alpha \frac{\bar{c}}{2V} \right] \right\}}{\left[mV - \bar{q}S C_{N_{q\alpha}}(|\alpha|) \cdot C_{N_{eq}}(q_{corr}, M) \cos \alpha \frac{\bar{c}}{2V} \right]^2} \\ &\quad - \frac{\bar{q}S C_{N_{q\alpha}}(|\alpha|) \cdot C_{N_{eq}}(q_{corr}, M) \sin \alpha \frac{\bar{c}}{2V} \left\{ \bar{q}S [BX + C_{L_{\delta_n\alpha}}(\delta_{neq}, \alpha)] + \sin \alpha T \right\}}{\left[mV - \bar{q}S C_{N_{q\alpha}}(|\alpha|) \cdot C_{N_{eq}}(q_{corr}, M) \cos \alpha \frac{\bar{c}}{2V} \right]^2} \cdot \dot{\alpha} \end{aligned} \quad (24)$$

With (21), the expression of $\dot{\alpha}$ as (25) can be gotten.

$$\begin{aligned} \dot{\alpha} &= \left[1 - \frac{\bar{q}S}{mV} C_{N_{q\alpha}}(|\alpha|) \cdot C_{N_{eq}}(q_{corr}, M) \cos \alpha \frac{\bar{c}}{2V} \right] (q - q_{eq}) \\ &\quad - \frac{\bar{q}S}{mV} D[C_{L_{\delta_n\alpha}}(\delta_{neq}, \alpha)] (\delta_n - \delta_{neq}) \end{aligned} \quad (25)$$

With (25), (24) can be rewritten as (26).

$$\begin{aligned} \dot{q}_{eq} &= \frac{dq_{eq}}{dt} \cdot \dot{\alpha} \\ &= \frac{\left\{ \bar{q}S [BX^\alpha + C_{L_{\delta_n\alpha}}^\alpha(\delta_{neq}, \alpha)] + \cos \alpha \cdot T \left[mV - \bar{q}S C_{N_{q\alpha}}(|\alpha|) \cdot C_{N_{eq}}(q_{corr}, M) \cos \alpha \frac{\bar{c}}{2V} \right] \right\}}{\left[mV - \bar{q}S C_{N_{q\alpha}}(|\alpha|) \cdot C_{N_{eq}}(q_{corr}, M) \cos \alpha \frac{\bar{c}}{2V} \right]^2} \\ &\quad - \frac{\bar{q}S C_{N_{q\alpha}}(|\alpha|) \cdot C_{N_{eq}}(q_{corr}, M) \sin \alpha \frac{\bar{c}}{2V} \left\{ \bar{q}S [BX + C_{L_{\delta_n\alpha}}(\delta_{neq}, \alpha)] + \sin \alpha T \right\}}{\left[mV - \bar{q}S C_{N_{q\alpha}}(|\alpha|) \cdot C_{N_{eq}}(q_{corr}, M) \cos \alpha \frac{\bar{c}}{2V} \right]^2} \\ &\quad \cdot \left\{ \left[1 - \frac{\bar{q}S}{mV} C_{N_{q\alpha}}(|\alpha|) \cdot C_{N_{eq}}(q_{corr}, M) \cos \alpha \frac{\bar{c}}{2V} \right] (q - q_{eq}) - \frac{\bar{q}S}{mV} D[C_{L_{\delta_n\alpha}}(\delta_{neq}, \alpha)] (\delta_n - \delta_{neq}) \right\} \end{aligned} \quad (26)$$

Define

$$DX = \frac{\left\{ \bar{q}S [BX^\alpha + C_{L_{\delta_n\alpha}}^\alpha(\delta_{neq}, \alpha)] + \cos \alpha \cdot T \left[mV - \bar{q}S C_{N_{q\alpha}}(|\alpha|) \cdot C_{N_{eq}}(q_{corr}, M) \cos \alpha \frac{\bar{c}}{2V} \right] \right\}}{\left[mV - \bar{q}S C_{N_{q\alpha}}(|\alpha|) \cdot C_{N_{eq}}(q_{corr}, M) \cos \alpha \frac{\bar{c}}{2V} \right]^2} - \frac{\bar{q}S C_{N_{q\alpha}}(|\alpha|) \cdot C_{N_{eq}}(q_{corr}, M) \sin \alpha \frac{\bar{c}}{2V} \left\{ \bar{q}S [BX + C_{L_{\delta_n\alpha}}(\delta_{neq}, \alpha)] + \sin \alpha T \right\}}{\left[mV - \bar{q}S C_{N_{q\alpha}}(|\alpha|) \cdot C_{N_{eq}}(q_{corr}, M) \cos \alpha \frac{\bar{c}}{2V} \right]^2},$$

where

$$\begin{aligned}
 BX^\alpha = & \left[-C_{N_0}(M) \sin \alpha - C_{T_0}(M) \cos \alpha \right. \\
 & - C_{N_{\delta_n \alpha}}(0, \alpha) C_{N_{eq}}(q a_{corr}, M) \sin \alpha \\
 & \left. + \left[C_{N_{\delta_n \alpha}}^\alpha(0, \alpha) C_{N_{eq}}(q a_{corr}, M) \cos \alpha - C_{T_\alpha}(\alpha) \cos \alpha - C_{T_\alpha}^\alpha(\alpha) \sin \alpha \right] \right]
 \end{aligned}$$

Equation (21) less (27) and (28) can be gotten.

Then (26) can be rewritten as (27).

$$\begin{aligned}
 \dot{q}_{eq} = & DX \cdot \left\{ \left[1 - \frac{\bar{q}S}{mV} C_{N_{q\alpha}}(|\alpha|) \cdot C_{N_{eq}}(q a_{corr}, M) \cos \alpha \frac{\bar{c}}{2V} \right] (q - q_{eq}) \right. \\
 & \left. - \frac{\bar{q}S}{mV} D \left[C_{L_{\delta_n \alpha}}(\delta_{neq}, \alpha) \right] (\delta_n - \delta_{neq}) \right\}
 \end{aligned} \tag{27}$$

$$\begin{aligned}
 \begin{bmatrix} \dot{\alpha} \\ \dot{q} - \dot{q}_{eq} \end{bmatrix} = & \begin{bmatrix} 0 & 1 - \frac{\bar{q}S}{mV} C_{N_{q\alpha}}(|\alpha|) \cdot C_{N_{eq}}(q a_{corr}, M) \cos \alpha \frac{\bar{c}}{2V} \\ 0 & \frac{\bar{q}S \bar{c}}{I_y} \left[C_{m_{q\alpha}}(\alpha) + C_{m_{\delta_n \alpha}}(\delta_n, \alpha) \right] \cdot C_{N_{eq}}(q a_{corr}, M) \frac{\bar{c}}{2V} - DX \cdot \left[1 - \frac{\bar{q}S}{mV} C_{N_{q\alpha}}(|\alpha|) \cdot C_{N_{eq}}(q a_{corr}, M) \cos \alpha \frac{\bar{c}}{2V} \right] \end{bmatrix} \begin{bmatrix} \alpha \\ q - q_{eq} \end{bmatrix} \\
 + & \begin{bmatrix} -\frac{\bar{q}S}{mV} D \left[C_{L_{\delta_n \alpha}}(\delta_{neq}, \alpha) \right] \\ \frac{\bar{q}S \bar{c}}{I_y} D \left[C_{m_{\delta_n \alpha}}(\delta_{neq}, \alpha) \right] + DX \cdot \frac{\bar{q}S}{mV} D \left[C_{L_{\delta_n \alpha}}(\delta_{neq}, \alpha) \right] \end{bmatrix} \begin{bmatrix} \delta_n - \delta_{neq} \end{bmatrix},
 \end{aligned} \tag{28}$$

where δ_{neq} and q_{eq} can be gotten from (20). And (28) is the quasi-linear model that is the result.

IV. SIMULATIONS

Now the quasi-linear model has been gotten, but it should be checked to make sure whether it is right by the simulation method. Programming with MATLAB, solving (18) and (28) by the method of fourth-order Runge-Kutta, letting them have the same initial values and conditions, and setting simulation step to be 0.01s and simulation time to be 3s, the curves as Fig. 10 and Fig. 11 can be gotten.

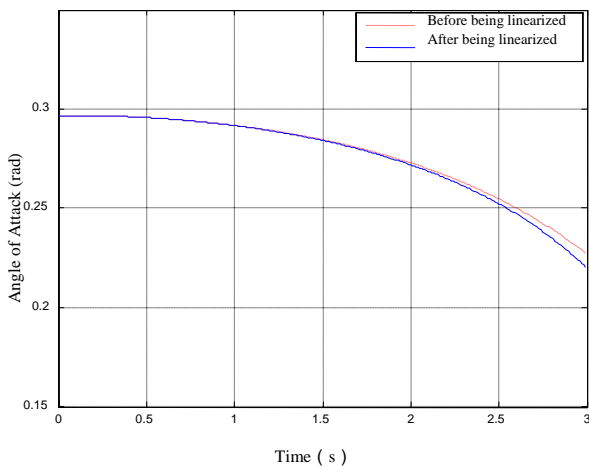

Fig. 10 The curves of Angle of Attack

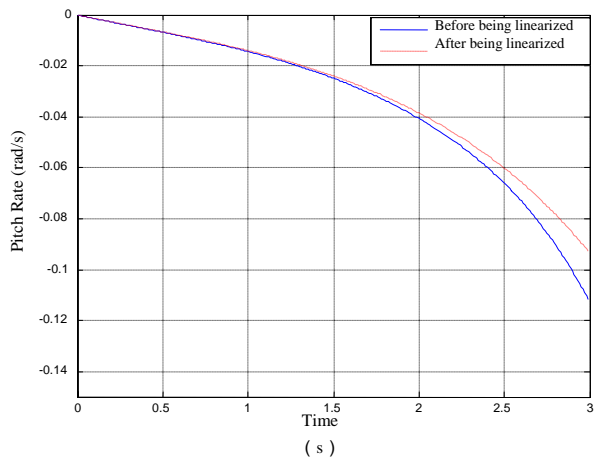

Fig. 11 The curves of Pitch Rate

From the Fig. 10 and the Fig. 11 and the results of the simulations, it can be found that the two curves have difference when t become larger. The errors are result from the linearization of $C_{L_{\delta_n \alpha}}(\delta_n, \alpha)$ and $C_{m_{\delta_n \alpha}}(\delta_n, \alpha)$. But the errors are very small. So it can be concluded that the quasi-linear model is accurate enough.

V. CONCLUSION

In this paper, a longitudinal quasi-linear model of ADMIRE has been presented by using state transformation method. Because there is only once linearization in the process of establishing, the model can reflect the dynamic characteristics of aircraft very accurately, which is very helpful to the design of control system for aircraft with high angle of attack. And satisfactory results are gotten in the simulations experiment.

REFERENCES

- [1] Forssell. L. S, Hovmark. G, Hyden. A, and Johansson. F, "The Aero-Data Model in a Research Environment (ADMIRE) for Flight Control Robustness Evaluation," Technical Report. GARTUER/TP-119-7.2001.
- [2] Shamma. J. S, and Cloutier. J. R, "Gain-scheduled missile autopilot design using linear parameter varying transformations," Journal of Guidance, Control and Dynamics J., 1993, 16(2): 256-263..
- [3] Xingfang. Qian, Ruixiong. Lin, Yanan. Zhao, Missile Flight Dynamics. Beijing, CA: Beijing Institute of Technology Press, 2000, pp.36-53
- [4] Andres. Marcos, and Gary J. Balas, "Development of Linear-Parameter-Varying Models for Aircraft," Journal of Guidance, Control, and Dynamics. J., 2004, 27(2):218-228.
- [5] Shin, J. Y., "Worst-Case Analysis and Linear Parameter-Varying Gain-Scheduled Control of Aerospace System," Ph.D. Dissertation, Dept. of Aerospace and Engineering Mechanics, Univ. of Minnesota, Minneapolis, Oct. 2000.
- [6] Papageorgiou, G., and Glover, K., "Design, Analysis and Flight Testing of a Robust Gain Scheduling Controller for the VAAV Harrier," DERA, Tech. Rep. TR-CUED/F-INFENG/TR.368, Univ. of Cambridge, U.K., Feb. 2000.
- [7] Tan, W., "Applications of Linear Parameter-Varying Control Theory," Master's Thesis, Dept. of Mechanical Engineering, Univ. of California at Berkeley, May 1997.
- [8] Papageorgiou, G., "Robust Control System Design H_∞ Loop Shaping and Aerospace Application," Ph.D. Dissertation, Dept. of Engineering, Univ. of Cambridge, Cambridge, England, U.K., July. 1998.